

PANTHER

Rugged IP65/IP67 Waterproof



- Designed for use in rail, earth moving, battery and related applications
- Meets EN45545-2 HL3 requirements

www.connectpositronic.com

M04U-1U-NC



Positronic®



OVERVIEW

In the world of electronics, the ability of the equipment to withstand harsh environments is becoming increasingly critical. The Panther family addresses that need by offering IP65/IP67 sealing capability along with increased operating temperature ranges. It also meets smoke and toxicity requirements common in aerospace, rail and other passenger applications.

- ✓ **IP65/IP67 in mated condition**
- ✓ **Operating temperatures to 200°C**
- ✓ **Meets smoke and toxicity requirements**

TECH SPECS

03 Layout Only

PART NUMBER PREFIX	PA03
PERFORMANCE LEVEL	Industrial Mil/aero
CONTACT STYLE	Fixed Removable
FEMALE CONTACT DESIGN	PosiBand
MECHANICAL OPERATIONS	1000
CONTACT TERMINATIONS	Crimp Straight solder Right angle solder Straight press-fit*1
CONTACT RETENTION	Fixed - 45 N [10 lbs] min Removable - 67 N [15 lbs] min
RETENTION MECHANISM	Press-in (fixed) Metal clip (removable)
PROOF VOLTAGE (RMS)	5000 V
WORKING VOLTAGE (RMS)	1600 V
INSULATOR MATERIAL	LCP
INSULATOR COLOR	Black
INSULATOR CONSTRUCTION	Monoblock
INSULATION RESISTANCE	5 GΩ (min)
POLARIZATION	Trapezoidal shape
TEMPERATURE RANGE	-55 to 200°C
RESISTANCE TO WAVE SOLDER HEAT	350°C for 3 seconds
SHOCK & VIBRATION	EIA-364-28F, test condition IV
SALT SPRAY	48 hours
UV PROTECTION	Rated (f1) per UL 746C
QUALIFICATIONS*2	IP65/IP67 EN45545-2 HL3 (R22/R23) NFF 16-101/102

All Positronic contacts are machined from solid copper alloy and plated gold for maximum performance. Gold plating thickness options include gold flash, 30 microinches and 50 microinches.

All insulators meet UL 94V-0 requirements.

*1 Contact Technical Sales for availability.

*2 The listed qualification may not apply to all products within the family. Safety agency certifications not listed here may be pending at the time of printing. Contact Technical Sales for current status.

CONTACT LAYOUTS



LAYOUT	03	08	10
Contacts			
#12	3	2	
#18			10
#22		6	
Contact Current Rating (A) at 30°C Temperature Rise			
Standard	25	TBD	TBD
High Conductivity HC	35	TBD	TBD
Contact Resistance (mΩ)			
Standard	1.0	TBD	TBD
High Conductivity HC	0.4	TBD	TBD
Panel Mount (PCB or wire) Dimensions			
Width (mm)		53.00	
Height (mm)		26.00	
Free Cable Dimensions			
Width (mm)		51.00	
Height (mm)		20.00	
Wire Insulation Ø**			
#12	2.80 to 3.20		
#18		1.50 to 1.80	
#22			1.10 to 1.50
Availability	Fall 2016	Contact Technical Sales	Contact Technical Sales

** Contact Technical Sales for custom grommets intended for use with wire insulation diameters not listed above.

HC High conductivity

EXPLODED VIEW

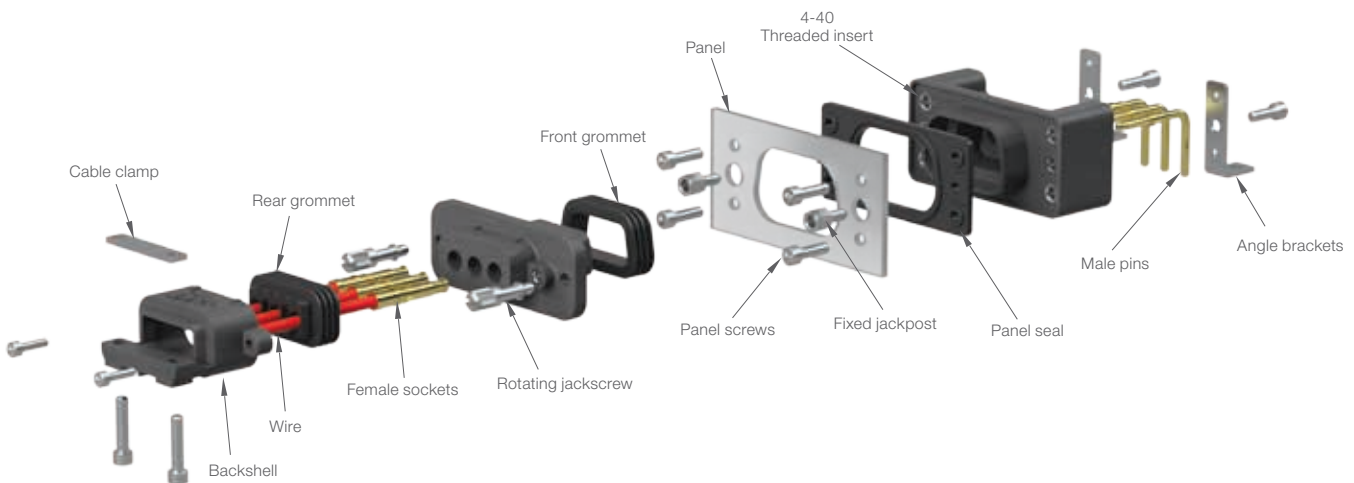

INSULATOR DIMENSIONS

FREE CABLE

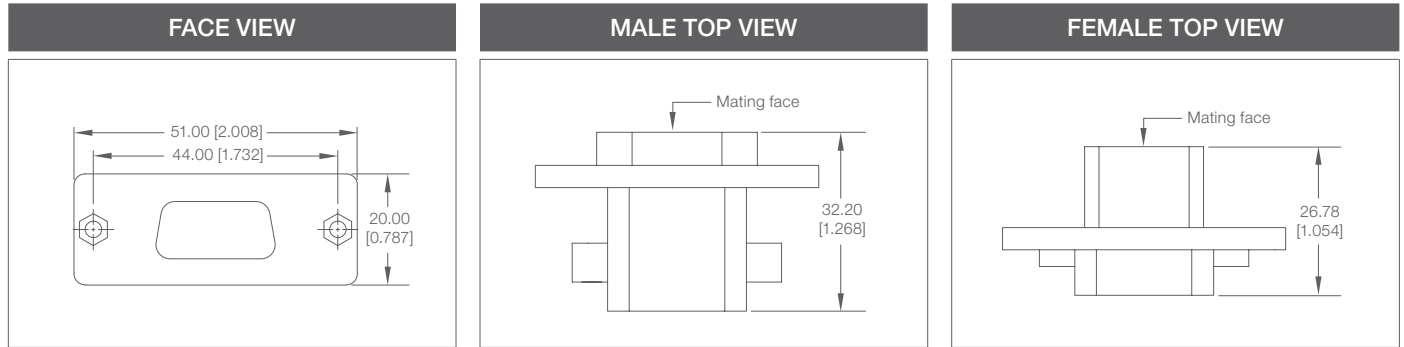

PANEL MOUNT (PCB)

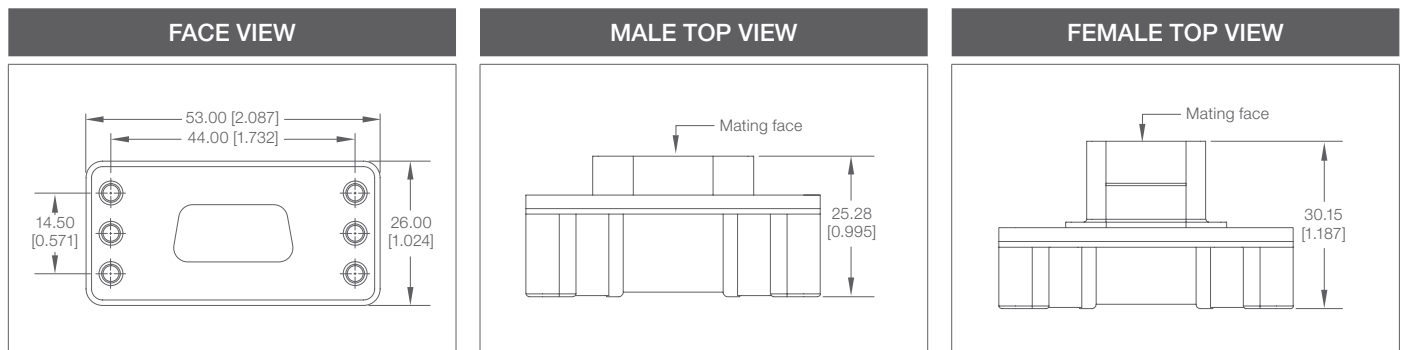

PANEL MOUNT (WIRE)

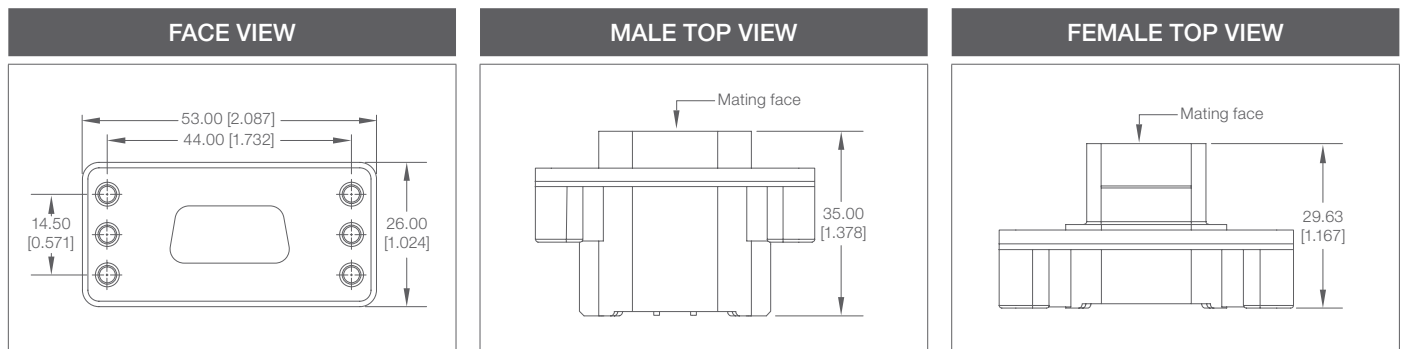

CREATE A PART

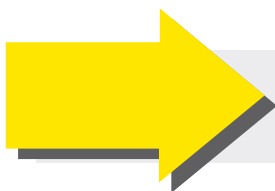
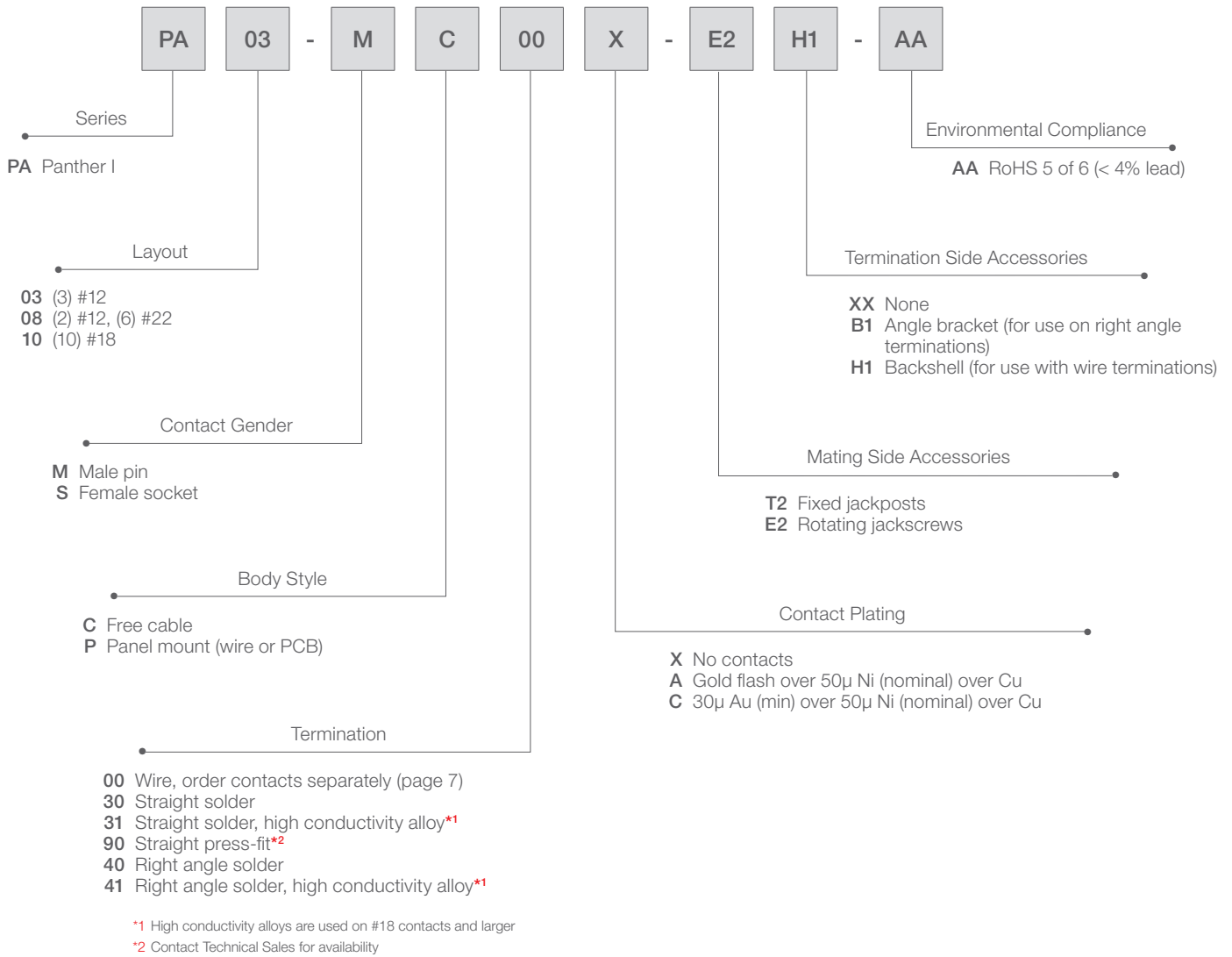

FOR MODIFICATIONS TO STANDARD PARTS,
PLEASE CONTACT TECHNICAL SALES.

FIXED CONTACT TERMINATIONS

	03	08	10
Straight solder			
Right angle solder			

Notes

- 1 For clarification purposes, select mechanical details have been removed.
- 2 Contact Technical Sales for press-fit terminations.

TEMPERATURE RISE CURVES

Tested per IEC Publication 512-3, Test 5a

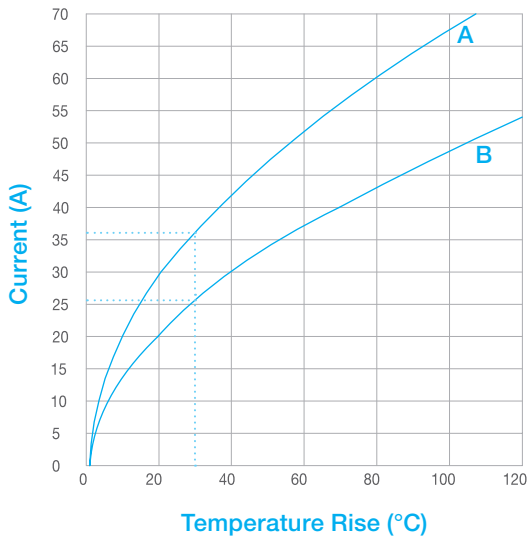

Temperature Rise (°C)

- A** Developed with (3) #12 high conductivity contacts with 10 AWG wire.
- B** Developed with (3) #12 standard conductivity contacts with 10 AWG wire.

REMOVABLE CRIMP CONTACTS

Copper alloy, rear insertion, front release

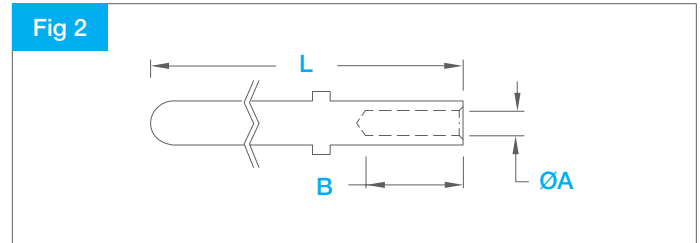
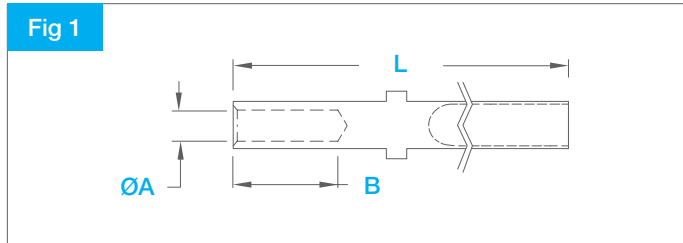





NOTES

1 Contact drawings are intended to be generic representations of actual mechanical detail. Contact Technical Sales for detailed drawings.

PART NUMBER	Fig	Size	Gender	Female Contact Style	Current Rating (A)	LLCR (mΩ)	Stranded AWG [mm ²]	L	ØA	B	Type
FC1210P2	1	#12	Female	PosiBand	25	1.0	#10 [5.3]	21.25 [0.837]	3.10 [0.122]	6.45 [0.254]	Power
HC FC1210P2S	1	#12	Female	PosiBand	35	0.4	#10 [5.3]	21.25 [0.837]	3.10 [0.122]	6.45 [0.254]	Power
FC1212P2	1	#12	Female	PosiBand	TBD	TBD	#12-14 [4.0-2.5]	21.25 [0.837]	2.54 [0.100]	6.45 [0.254]	Power
HC FC1212P2S	1	#12	Female	PosiBand	TBD	TBD	#12-14 [4.0-2.5]	21.25 [0.837]	2.54 [0.100]	6.45 [0.254]	Power
MC1210N-PA563	2	#12	Male	n/a	25	1.0	#10 [5.3]	23.18 [0.912]	3.10 [0.122]	6.45 [0.254]	Power
HC MC1210NS-PA563	2	#12	Male	n/a	35	0.4	#10 [5.3]	23.18 [0.912]	3.10 [0.122]	6.45 [0.254]	Power
MC1212N-PA563	2	#12	Male	n/a	TBD	TBD	#12-14 [4.0-2.5]	23.18 [0.912]	2.54 [0.100]	6.45 [0.254]	Power
HC MC1212NS-PA563	2	#12	Male	n/a	TBD	TBD	#12-14 [4.0-2.5]	23.18 [0.912]	2.54 [0.100]	6.45 [0.254]	Power
FC1816P2	1	#18	Female	PosiBand	TBD	TBD	#16-18 [1.5-1.0]	19.34 [0.761]	1.70 [0.067]	6.50 [0.256]	Power
HC FC1816P2S	1	#18	Female	PosiBand	TBD	TBD	#16-18 [1.5-1.0]	19.34 [0.761]	1.70 [0.067]	6.50 [0.256]	Power
FC1820P2	1	#18	Female	PosiBand	TBD	TBD	#20 [0.5]	19.34 [0.761]	1.14 [0.045]	6.50 [0.256]	Power
HC FC1820P2S	1	#18	Female	PosiBand	TBD	TBD	#20 [0.5]	19.34 [0.761]	1.14 [0.045]	6.50 [0.256]	Power
MC1816N-PA561	2	#18	Male	n/a	TBD	TBD	#16-18 [1.5-1.0]	21.08 [0.830]	1.70 [0.067]	6.50 [0.256]	Power
HC MC1816NS-PA561	2	#18	Male	n/a	TBD	TBD	#16-18 [1.5-1.0]	21.08 [0.830]	1.70 [0.067]	6.50 [0.256]	Power
MC1820N-PA561	2	#18	Male	n/a	TBD	TBD	#20 [0.5]	21.08 [0.830]	1.14 [0.045]	6.50 [0.256]	Power
HC MC1820NS-PA561	2	#18	Male	n/a	TBD	TBD	#20 [0.5]	21.08 [0.830]	1.14 [0.045]	6.50 [0.256]	Power
FC422P9	1	#22	Female	PosiBand	TBD	TBD	#22 - 26 [0.30-0.12]	11.41 [0.449]	0.89 [0.035]	3.46 [0.136]	Signal
MC422N9-PA1007	2	#22	Male	n/a	TBD	TBD	#22 - 26 [0.30-0.12]	15.49 [0.610]	0.89 [0.035]	3.35 [0.132]	Signal

HC High conductivity

See www.connectpositronic.com/panther
for all other Panther-related
information including:

- ✓ **Footprints** 
- ✓ **Tooling** 
- ✓ **Product updates** 
- ✓ **Detailed dimensions** 
- ✓ **2D/3D drawings** 

All dimensional tolerances are ± 0.38 [0.015], unless otherwise specified. Dimensions are in millimeter [inches]. All dimensions are subject to change. Product pictures may not be identical in appearance to actual production parts.

Information in this catalog is proprietary to Positronic and its subsidiaries. Positronic believes the data contained herein to be reliable. Since the technical information is given free of charge, the user employs such information at his own discretion and risk. Positronic assumes no responsibility for results obtained or damages incurred from use of such information in whole or in part.

The following trademarks are owned by Positronic Industries, Inc.: Positronic Industries, Inc.®, Positronic®, Connector Excellence®, P+ logo®, PosiBand®, PosiShop®, Positronic Global Connector Solutions™, Global Connector Solutions™ and Optik-D™. The color blue as it appears on various connectors is a trademark of Positronic Industries, Inc., Registered in U.S. Patent and Trademark Office.

Products described within this catalog may be protected by one or more of the following US patents:

#4,9000,261` #5,255,580 #5,329,697
#7,115,002 #8,944,697 #9,304,263

Patented in Canada, 1992 Other patents pending

Positronic | Americas

423 N Campbell Ave
Springfield MO 65806 USA
+1 800 641 4054
info@connectpositronic.com

Positronic | Europe

46 route d'Engachies
F-32020 Auch Cedex 9 France
+33 5 6263 4491
contact@connectpositronic.com

Positronic | Asia

3014A Ubi Rd 1 #07-01
+65 6842 1419
Singapore 408703
singapore@connectpositronic.com

Sales Offices

Positronic has local sales representation all over the world. For the nearest sales office visit www.connectpositronic.com/sales