

# PIEZO AUDIO AMPLIFIERS

PAA series

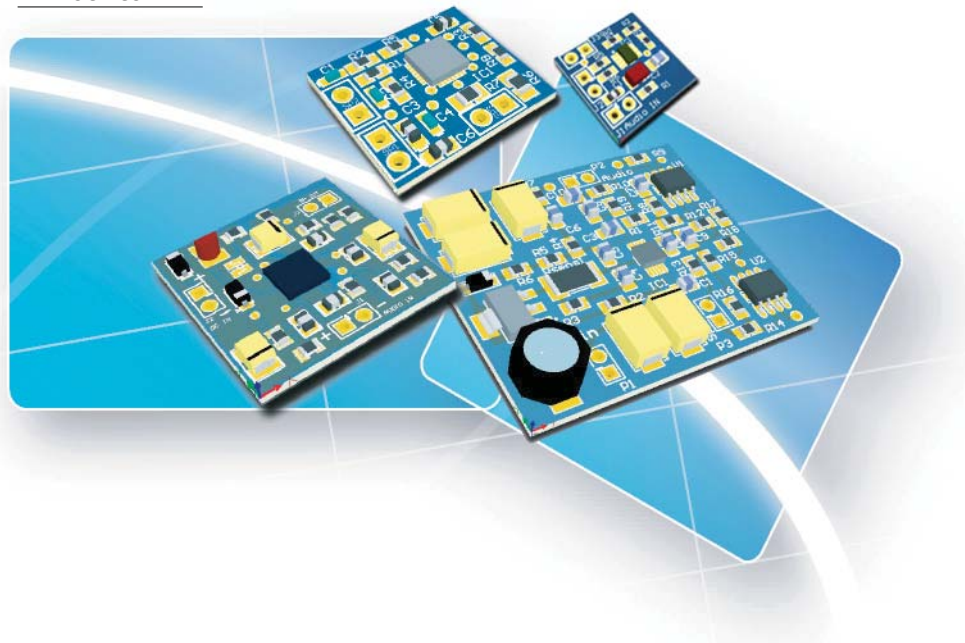

*In parallel with the amplifiers developed at Sonitron we refer to various integrated circuits available on the market.*

## PIEZO AUDIO AMPLIFIERS

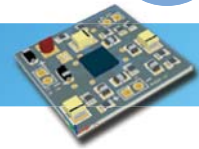

### INTRODUCTION

The **P**iezo **A**udio **A**mplifiers-series are a total solution to drive piezoceramic sound components. A range of different PCB sizes, amplifier topologies and maximum voltage peak to peak outputs, cover a wide solution to piezo audio amplification.

Piezo audio amplifiers are designed to handle capacitive loads and have the possibility to deliver large voltages peak to peak over the complete audio frequency range.

The heart of a piezo audio component is a ceramic piezo stone that interacts when it feels a certain voltage difference. An increase of a voltage peak to peak will have a larger piezo deformation and results in a larger sound output.

The PAA-series give a quality amplifier solution where a quality sound is needed.

### GENERAL OVERVIEW PAA SERIES

Model	PAA-LT3469-01	PAA-MAX9788-01	PAA-LM4960-02	PAA-StepUpBTL-01
Measurements PCB(mm)	15x15mm	14x16.5mm	25x25mm	40x35mm
Voltage input (V)	5V	5V	5V	5V-25V
MAX Capacitance Piezo Speaker	200nF	1µF	600nF	1µF
Max Voltage Output Vpp	33Vpp	20Vpp	24Vpp	60Vpp
Voltage Topology	Integrated step Up converter	Integrated step up converter	Integrated step up converter	Step up converter
Amplifier classification	Class A	Class G	Class AB	Class AB
Used amplifier configuration	Single ended	Fully Differential	Bridge Tied Load	Bridge Tied Load
Average current consumption of speaker and amplifier (mA)	45mA	15mA	85mA	40mA-400mA (2 Watt)

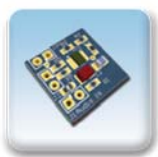

**PAA-LT3469-01**



**PAA-MAX9788-01**

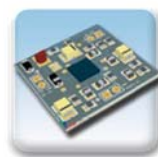

**PAA-LM4960SQ-02**

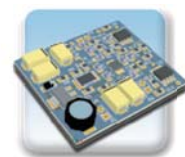

**PAA-StepUpBTL-01**

## BASICS OF PIEZO AUDIO AMPLIFIERS

$$PAA = P_{\text{piezo}} A_{\text{audio}} A_{\text{amplifier}}$$

An amplifier for audio signals special designed to drive capacitive loads.

**Max Cap.:** The maximum capacitance the Piezo Audio amplifier can handle.

-*Load Capacitance:* The main impedance of the Piezo Speaker or Piezo vibration element is a capacitance with values mostly between 10nF and 1µF.

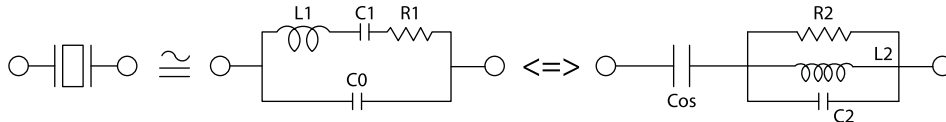

Simple Equivalent electronic circuits of a piezo element:

**Max Vpp:** Maximum voltage peak to peak that an amplifier can deliver at his output channel.

-*Max speaker Vpp:* Maximum voltage swing a piezo speaker can handle to work correctly within the described life time.

-*The heart of a Piezo speaker* is the piezo ceramic stone that interacts with voltage differences. How larger the voltage difference how more intense the amplitude of the sound will be.

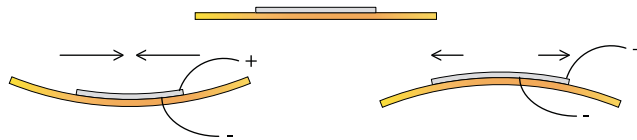

## PIEZO AUDIO AMPLIFIER SERIES

### PAA-LT3469-01

A PCB of only 2.25cm<sup>2</sup>. The LT3469 is a very small signal amplifier up to 30Vpp.

- Integrated charge pump power supply
- Class A Amplifier
- Single ended
- Capacitive load up to 250nF
- 10 components

total thickness:  
2.7 mm

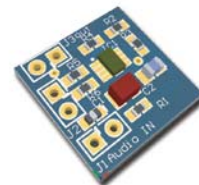
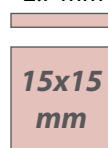

Fixed amplification ratio: +/- 131  
Voltage input: 5 V

### PAA-MAX9788-01

Designed on a printed circuits board of only 2,31 cm<sup>2</sup>, the "Max9788" piezo audio amplifier of Maxim fulfils the needs of very small designs in portable applications. A maximum output of 20Vpp and very low power consumption makes it even more attractive.

- Integrated charge pump power supply
- Class G Amplifier
- Fully differential inputs and outputs
- Capacitive load up to 1µF
- 15 components

total thickness:  
1.88 mm

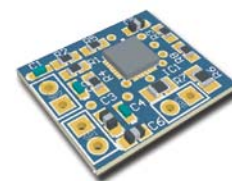
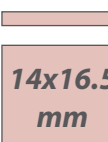

Fixed amplification ratio: +/- 80  
Voltage input: 5 V

## PAA-LM4960SQ-02

A perfect balance of a bridge tied load and step up converter on a small PCB, the "LM4960" IC of National Semiconductor reaches 24 Vpp for a load of 600nF. Small design and great sound output makes it very understandable.

- Integrated Step Up Converter
- Bridge tied load
- Very small inductor
- Up to 24Vpp
- 22 components

total thickness:  
4.25 mm

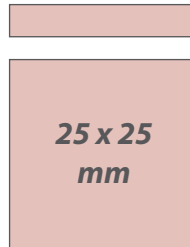

actual size

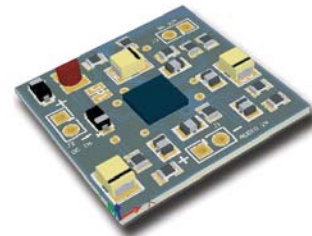

Fixed amplification ratio: +/- 74  
Voltage input: 5 V

## PAA-StepUpBTL-01

To go loud is to amplify the input signal to a large Voltage peak to peak swing of maximum 60Vpp. Tuned on the SPS piezo speakers the "StepUpBTL" piezo audio amplifier is designed for a very loud audio sound in a room.

The creation of a 60Vpp swing derives from a stable DC power source of 30 V DC.

The boostconverter circuit is designed to a minimum surface with a maximum variety at the input source. A variation of the input voltage between 5V and 25V gives at the end a stable 30VDC to power the opamps with efficient power consumption.

The amplifier circuit is a perfect balance between power consumption and space design. The Bridge Tied Load amplifier topology makes it possible to swing the signal to 60Vpp.

- Input voltage 5V-25V
- Max. output 60Vpp
- Two electronic circuits
- **Ideal: +input: 9Vdc**  
**+output: 40Vpp**

total thickness:  
6 mm

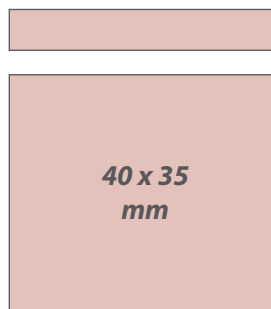

actual size

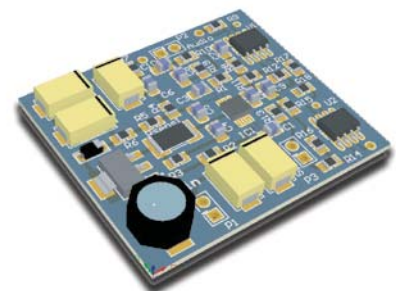

Fixed amplification ratio: +/- 90  
Voltage input: 5-25 V

### Boost converter + Amplifier

- DC-DC- converter: Max 669  
=> output: 30 Vdc
- Amplifier circuit: OPA 551  
=>"Bridge tied load configuration"

## ADDITIONAL INFORMATION

### DEMONSTRATION UNIT DU6597 & DU65SB

The DU6597 & DU65SB is a small speaker demonstration unit that consists of a piezoceramic speaker (SPS6555) and a piezo audio amplifier (PAA-MAX9788 or PAA-StepUpBTL-01).

The **SPS-6555-03** is a polymer/metal speaker with a very flat frequency response. The use of a piezoceramic disc as the heart of the speaker does not generate an electromagnetic field and ensures EMC requirements.

The **PAA-MAX9788** is a fully differential piezo audio amplifier with a class G topology. It is designed for applications where efficiency and small dimensions are a priority and can deliver a signal up to 20Vpp at 5V.

The **PAA-StepUpBTL-01** delivers 60Vpp audio output for loud applications.

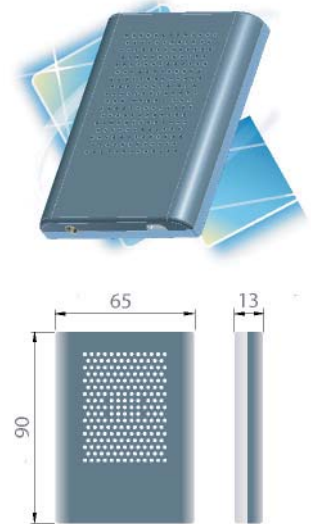

### PRESENTATION EXAMPLES



Presentation with portable PC

The DU6597 & DU65SB is designed for use with MP3-players and the headphone output of a portable PC.

Please note: Other outputs or signals than the music headphone output can damage the

The power source comes from a USB power port and delivers 5V to the piezo audio amplifier. If no USB powerport is available an adapter can be used. In this case we recommend the iPod USB Power Adapter.



Presentation with MP3-player

## PAA Sample kit

The PAA Sample kit gives you the freedom to do experiments with a piezoceramic audio speaker SPS-6555-03 and four different piezo audio amplifiers. The SPS-6555-03 piezo speaker is built-in a small case for optimum sound quality.

PAA amplifiers:

- PAA-LT3469-01
- PAA-MAX9788-01
- PAA-LM4960SQ-02
- PAA-StepUpBTL-01



## Blind power dissipation in a piezoceramic load (for a sine wave)

The power dissipation in an electro-dynamic speaker depends on the resistance of the drive coil. In our comparison, the power dissipated in an electrodynamic speaker with  $\varnothing$  68 mm and  $16\Omega$  impedance @ 2V is:

$$\frac{V^2}{R} = \frac{4}{16} = 0,25 \text{ W}$$

The power dissipation in a piezo capacitive load, not in resonance, is:

$$\frac{P}{2} = \frac{c \cdot V^2 \cdot \omega \cdot \cos \varphi}{2} + \frac{c \cdot V^2 \cdot \omega \cdot D_F}{2} = \frac{c \cdot V^2 \cdot \omega}{2} \cdot (\cos \varphi + D_F)$$

capacitive power
power dissipated in ceramic

$D_F$ : Dissipation factor of the ceramic material

$c$ : Capacitance of speaker

$\omega$ :  $2\pi f$

$V$ : Drive voltage

$\cos \varphi$ : The phase angle between current consumption and voltage (in a capacitor is this angle  $90^\circ$  before in phase, thus  $\cos \varphi = 0$ )

In theory, the capacitive power is zero. The power dissipated in the ceramic disc of the speaker depends strongly on the dissipation factor of  $D_F$  of the used ceramic. The  $D_F$  is a measure of the dielectric losses in the material, defined as the tangent of the loss angle or the ratio of parallel resistance to parallel reactance, expressed in percent and measured at 1 kHz. This dissipation factor can vary from 0,4% up to 2% for the most typical ceramics available.

Our speakers are not used at resonance. Consequently the power dissipated mainly depends on the  $D_F$  and is very low or near zero.

The power dissipation of the piezo speaker can be considered as a blind power drain. The amplifier must deliver the total power needed to drive the circuit. Thus the total power drain of the piezo speaker is the drain of the amplifier, needed to deliver the blind power for the speaker, the power dissipated in the ceramics (due to the dissipation factor) and the power dissipated in the isolation resistor  $R_{ISO}$ .

## THE IMPORTANCE OF THE ISOLATION RESISTOR ( $R_{ISO}$ )

Amplifiers feeding capacitive loads can be stabilised in order to avoid oscillation at 180° degrees phase shift at certain feedback conditions.

There are many ways to stabilise an amplifier in combination with a capacitive load, but a small resistor  $R_{ISO}$  is very effective and easy to design-in. By adding an isolation resistor  $R_{ISO}$  in series with the amplifier output and the capacitive load of the speaker  $C_L$ , we improve the gain and phase margin over the entire frequency range.

By adding a  $R_{ISO}$  we create:

1. an extra  $F_{zero}$  ( $F_z$ ) in the transfer function
2. we reduce the frequency of the pole with an output load in the transfer function

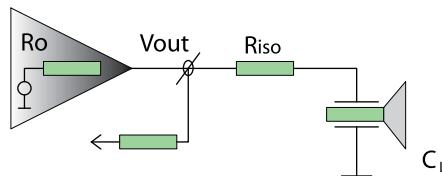

**$F_p$ :** At this frequency, the poles are represented by -45 degrees phase shift with -45 degrees per decade slope, extending this line with 0 degree and -90 degrees horizontal lines.

$$F_p = \frac{1}{2\pi C_L (R_o + R_{ISO})}$$

**$F_z$ :** At this frequency, the phase for zero is represented by a +45 degrees phase shift at the frequency of zero with +45 degrees per decade slope, extending this line with 0 degree and +90 degrees horizontal lines.

$$F_z = \frac{1}{2\pi C_L R_{ISO}}$$

The  $F_z$  in the transfer function is the product of  $R_{ISO}$  and  $C_L$ . The phase improvement is:

$$\Delta \theta : \tan^{-1} (2\pi \cdot UGBW \cdot R_{ISO} \cdot C_L)$$

- $\Delta \theta$  = improvement in phase margin
- UGBW = unity gain bandwidth frequency
- $R_{ISO}$  = isolation resistor
- $C_L$  = capacitive load of the speaker

## APPLICATION NOTE

### Automatic Speaker/Microphone switch + (pre)amplifier

Sonitron's piezoceramic speakers are ideal for use in multifunctional applications (speaker/microphone combination), because of the high sensitivity of the speaker membrane when used as microphone. They can be used in highly integrated equipment, such as GSM, PDA, portable games,... where voice commands could be an added value to meet customer's requirements. The principle starts from an audio detector, which senses if there's an audio input signal present or not. If not, the speaker is used as microphone. If yes, normal speaker operation is automatically selected.

#### Absolute Maximum Ratings

- Supply voltage : 20 VDC (applied via Wall Adapter input)
- Max. load capacitance: 800 nF
- Power Dissipation : Internally limited
- Audio Input Voltage : -0.3 V... Vcc + 5.3 V

#### Electrical Characteristics

- Supply Voltage : 7...20 VDC (wall adapter input, 12 VDC recommended)
- Speaker drive voltage: 24 Vpp
- Audio input signal : 600 mVpp typical
- Quiescent supply current : 20 mA (microphone), 70 mA (speaker)
- Total harmonic distortion: typical <1%

#### Microphone sensitivity of Sonitron's speakers

Model	SPS-2220-03	SPS-3530-03	SPS-4640-03	SPS-6555-03	SPS-8770-03
Sensitivity	6.8 mV/Pa	2.6 mV/Pa	2.8 mV/Pa	2.9 mV/Pa	3.01 mV/Pa

(Measured with a 1kHz/94dB signal)

#### SCHEMATICS

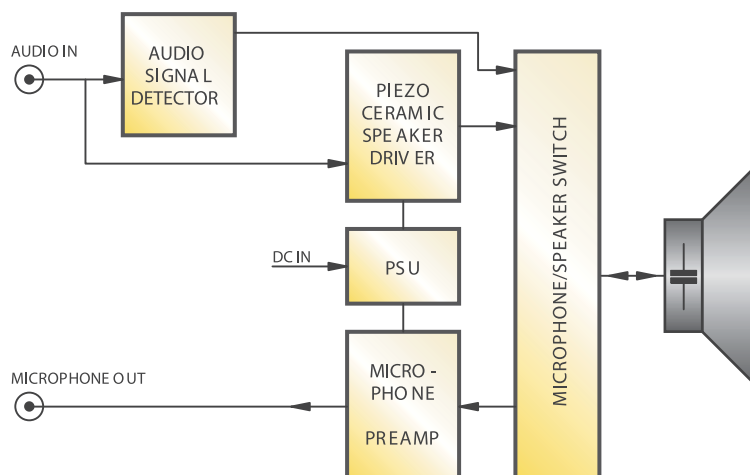



**Automatic Speaker/Microphone switch + (pre)amplifier**

