

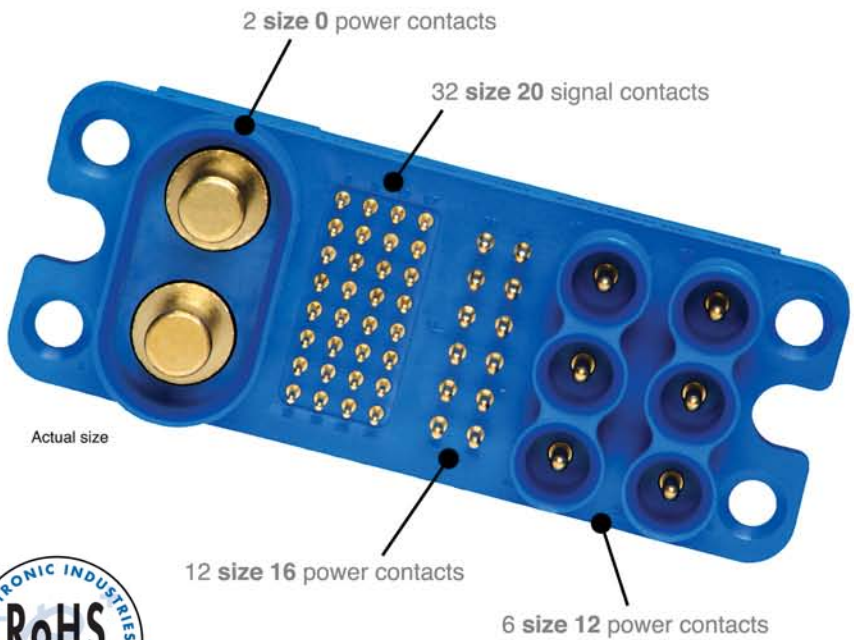

High Power Sumo connectors

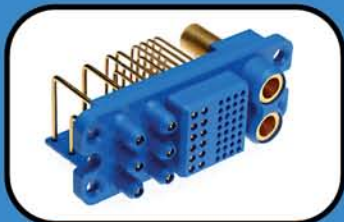

FEATURES:

- ◆ **Compatible** with existing power connectors for use in **drawer** applications
- ◆ Variety of contact sizes in a single package
- ◆ Available in cable, **right angle** and straight **board mount** versions
- ◆ Selective loading available on request
- ◆ Sequential mating options
- ◆ Outstanding **blind mating**

Contact us for more information on other Positronic interconnect products:

Technical Sales
(800) 641-4054
E-mail
info@connectpositronic.com
Web
www.connectpositronic.com

Connector Excellence

POSITRONIC INDUSTRIES

ABOUT US

Founded in 1966, Positronic Industries is a vertically integrated manufacturer of high quality interconnect products. Positronic has earned the worldwide reputation as a service oriented, quick-reaction, top quality connector supplier. We are committed to maintaining this reputation by continuous implementation of our **Complete Capability** concept.

COMPLETE CAPABILITY

Design & Development

- Designs new connectors and modifies existing connectors to meet industry requirements
- Continuously conducts marketing studies to identify industry needs for new products
- Ongoing interest in unique connector designs

Tooling

- Tooling support for all manufacturing areas within company
- Provides 80% of new tooling, punch press dies, molds, jigs and fixtures used at Positronic factory locations worldwide

Machining

- Automatic screw machines produce finely crafted contacts and hardware for connector bodies
- Trained technicians operate machines from Tornos, Bechler and Brown & Sharpe

Molding

- Molds all plastic connector components such as insulators, hoods, angle brackets and more
- Overmold capability available

Plating

- Applies gold and other metal finishes to connector components to any required thickness
- Plating conforms to all military specifications

Quality Assurance Lab

- Quality assurance system certified to ISO 9001
- Maintains aggressive TQM program
- Able to test to IEC, EIA, UL, MIL-DTL-24308, MIL-DTL-28748, MIL-C-39029 and MIL-C-85049 requirements

Finished Stock Inventory

- Each main factory location maintains a large inventory of connector components and accessories
- Same day shipments available on many standard connector products
- Stocking agreements available for qualified customers

Worldwide Sales & Service

- Responsive attitude toward customer needs
- Fully trained sales staff located worldwide



Machining



Molding



Finished Stock Inventory

Products described within this catalog may be protected by one or more of the following US. patents:

#4,721,472 #4,900,261 #5,255,580
#5,329,697 #6,260,268 #6,835,079

Patented in Canada, 1992 Other Patents Pending

Unless otherwise specified, **dimensional tolerances** are:

- 1) ± 0.03 mm [0.001 inches] for male contact mating diameters.
- 2) ± 0.08 mm [0.003 inches] for contact termination diameters.
- 3) ± 0.13 mm [0.005 inches] for all other diameters.
- 4) ± 0.38 mm [0.015 inches] for all other dimensions.

Positronic Industries believes the data contained herein to be reliable. Since the technical information is given free of charge, the User employs such information at his own discretion and risk. Positronic Industries assumes no responsibility for results obtained or damages incurred from use of such information in whole or in part.

Positronic Industries' FEDERAL SUPPLY CODE (Cage Code) FOR MANUFACTURERS is 28198



STANDARD TECHNICAL CHARACTERISTICS

MATERIALS AND FINISHES:

Insulator:	Glass-filled polyester, UL 94V-0, blue color.
Contacts:	Precision-machined copper alloy with gold flash over nickel. Solder-coated terminations optional. Other finishes available upon request.
Blind Mate Guides:	Stainless steel, passivated.
Float Mount Screw:	Stainless steel, passivated.

ELECTRICAL CHARACTERISTICS:

Contact Current Rating, per UL 1977:	
Size 0 Contact:	200 amperes, continuous.
Size 12 Contact:	35 amperes, continuous.
Size 16 Contact:	15 amperes, continuous.
Size 20 Contact:	5 amperes.
	Temperature Rise Curves per IEC 512-3, Test 5a. See next page for performance curves.
Initial Contact Resistance (in free air at rated current):	
Size 0 Contact:	0.074m ohms.
Size 12 Contact:	0.12m ohms.
Size 16 Contact:	0.32m ohms.
Size 20 Contact:	1.90m ohms.
	Per IEC 512-2, Test 2b.
Insulator Resistance:	5 G ohms per IEC 512-2, Test 3a.
Voltage Proof:	
Size 0 Contact:	3,000 VAC
Size 12 Contact:	3,000 VAC
Size 16 Contact:	2,000 VAC
Size 20 Contact:	1,700 VAC
Creepage Distances:	Consult Technical Sales.
Clearance Distance:	Consult Technical Sales.
Working Voltage:	
Size 0 Contact:	250 V
Size 12 Contact:	600 V
Size 16 Contact:	250 V
Size 20 Contact:	250 V

MECHANICAL CHARACTERISTICS:

Blind Mating System:	Blind mate guides allow for misalignment up to 4.00 mm [0.157 inch]
Polarization:	Provided by connector body design.
Removable Contacts: Size 12, 16, 20	Insert contact in rear face of insulator; release from front face of insulator. Female contacts feature "Closed Entry" design.
Removable Contact Retention in Connector Body: Size 0 Contact: Size 12 Contact: Size 16 Contact: Size 20 Contact:	67N [15 lbs.] per IEC 512-8, Test 15a. 67N [15 lbs.] per IEC 512-8, Test 15a. 67N [15 lbs.] per IEC 512-8, Test 15a. 44N [10 lbs.] per IEC 512-8, Test 15a.
Fixed Contacts:	Printed board terminations, both straight and right angle. Size 12 and 16 female contacts feature "Closed Entry" design. Size 20 female contacts feature "Rugged Open Entry" design.
Fixed Contact Retention in Connector Body:	44N [10 lbs.], minimum.
Resistance to Solder Heat:	260°C [500°F] for 10 seconds duration per IEC 512-6, Test 12e, 25-watt soldering iron.
Sequential Contact Mating System:	Three level systems featured for size 12, 16 and 20. Consult Technical Sales for application assistance with contact sequencing.
Printed Board and Panel Mounting Holes:	Mounting holes provided in connector body for both printed board and panel mounting.
Float Mount Shoulder Screw:	Provides up to 2.36 mm [0.093 inch] float.
Mechanical Operations:	200 couplings.

CLIMATIC CHARACTERISTICS:

Working Temperature:	-55°C to +125°C.
----------------------	------------------



For RoHS options, see page 13.



CONNECTOR TEMPERATURE RISE CURVES

Tested per IEC Publication 512-3, Test 5a

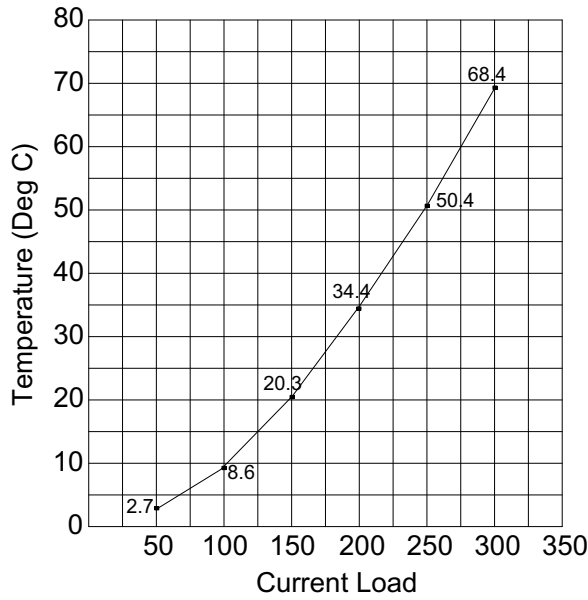

SIZE 0 CONTACTS

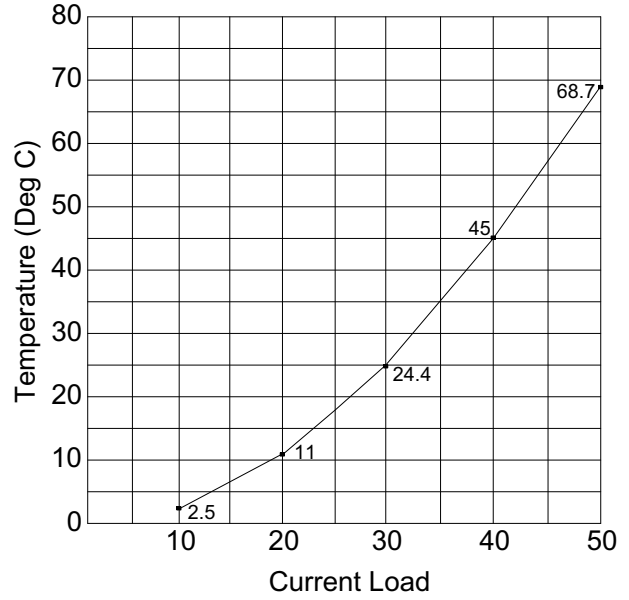

SIZE 12 CONTACTS

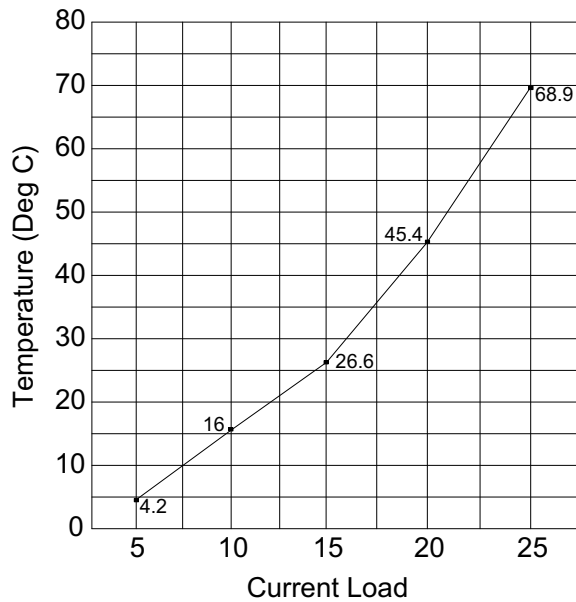

SIZE 16 CONTACTS

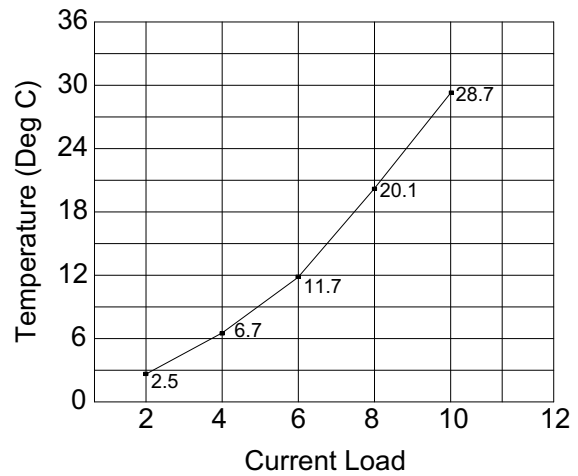

SIZE 20 CONTACTS

NOTE:

1) These temperature rise curves were developed in free air.



MALE CONNECTOR

Typical Part Number
SUM13M600A1

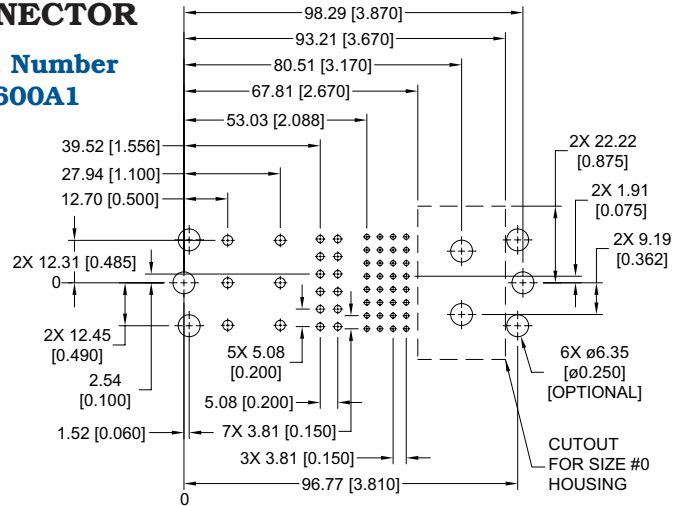
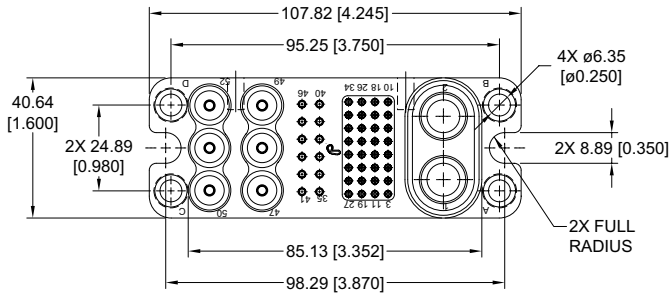

CONTACT HOLE PATTERN

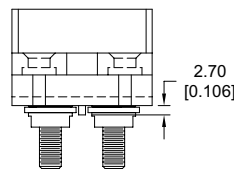
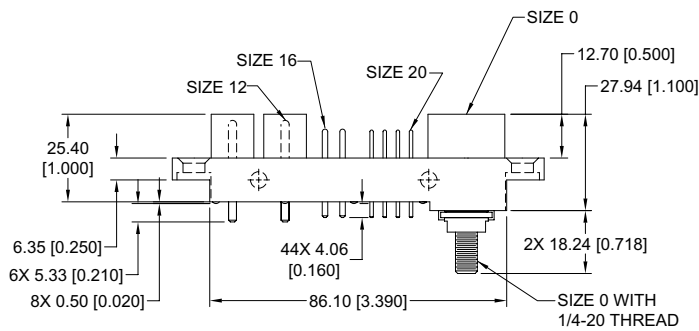

Contact Terminations:
Size 12: ø2.29 [0.090]
Size 16: ø1.60 [0.063]
Size 20: ø1.02 [0.040]

Note: See below for suggested printed board hole sizes.

FEMALE CONNECTOR

Typical Part Number
SUM13F600A1

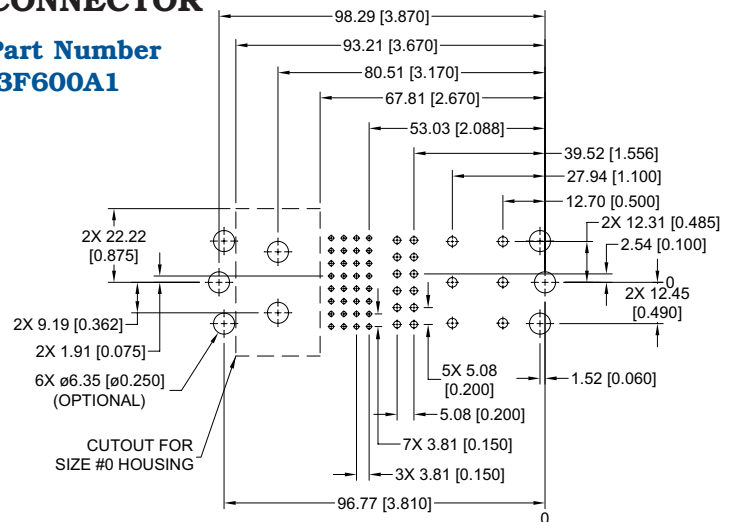
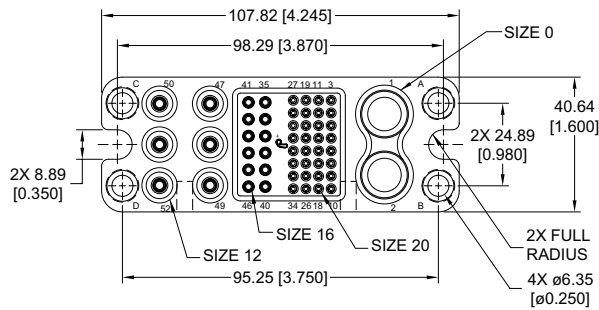

CONTACT HOLE PATTERN

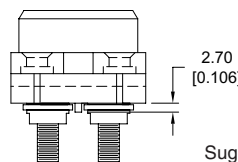
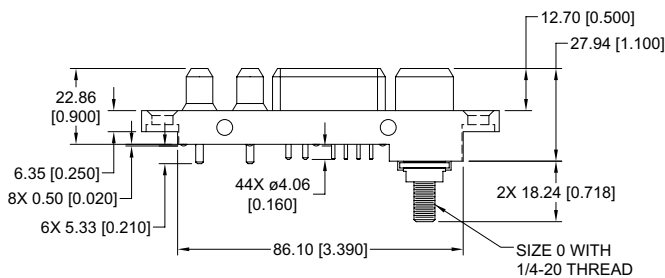

Contact Terminations:
Size 12: ø2.29 [0.090]
Size 16: ø1.60 [0.063]
Size 20: ø1.02 [0.040]

Suggest ø2.90 [0.114] holes for size 12 contact holes.
Suggest ø2.11 [0.083] holes for size 16 contact holes.
Suggest ø1.47 [0.058] holes for size 20 contact holes.
Suggest ø3.96 [0.156] holes for connector mounting holes.



Positronic Industries
connectpositronic.com

RIGHT ANGLE PRINTED BOARD MOUNT CONNECTORS

SUMO

BOARD MOUNT

MALE CONNECTOR

Typical Part Number
SUM14M6RS0A1

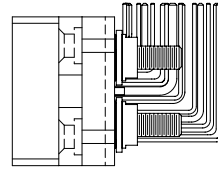
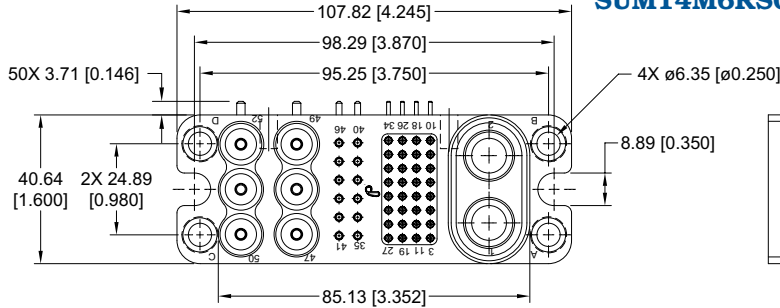

Contact Terminations:
Size 12: ø2.29 [0.090]
Size 16: ø1.60 [0.063]
Size 20: ø1.02 [0.040]

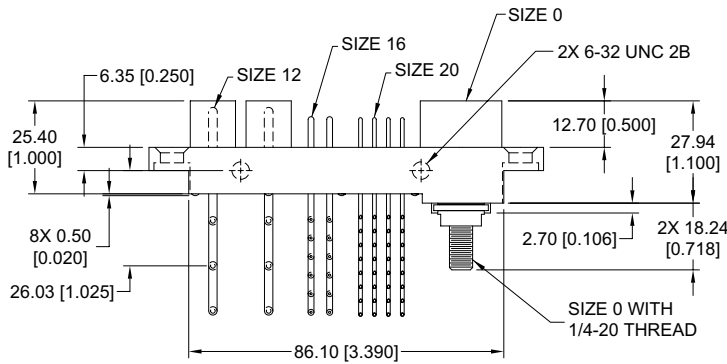

CONTACT HOLE PATTERN

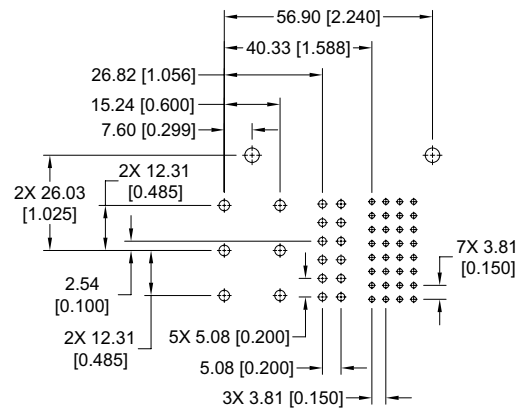

Note: See below for suggested printed board hole sizes.

FEMALE CONNECTOR

Typical Part Number
SUM14F6RS0A1

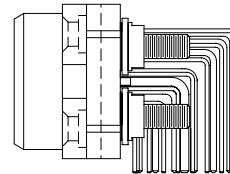
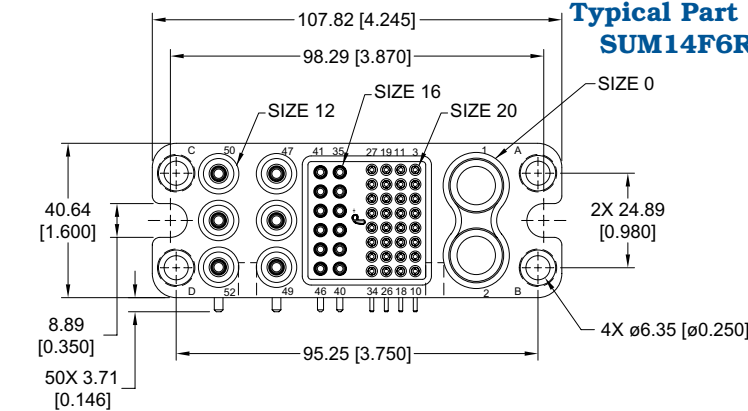

Suggest ø2.90 [0.114] holes for size 12 contact holes.
Suggest ø2.11 [0.083] holes for size 16 contact holes.
Suggest ø1.47 [0.058] holes for Size 20 contact holes.
Suggest ø3.96 [0.156] holes for connector mounting holes.

Contact Terminations:
Size 12: ø2.29 [0.090]
Size 16: ø1.60 [0.063]
Size 20: ø1.02 [0.040]

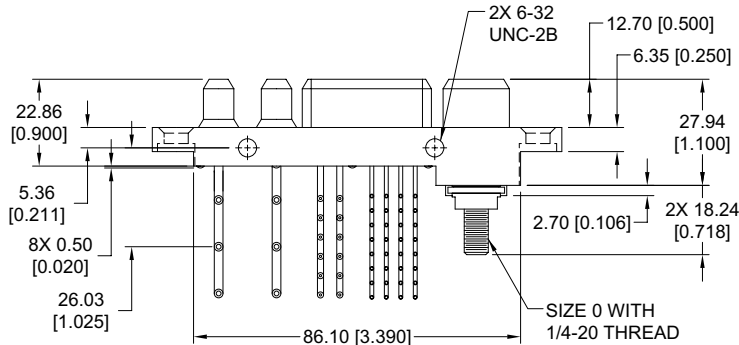

CONTACT HOLE PATTERN

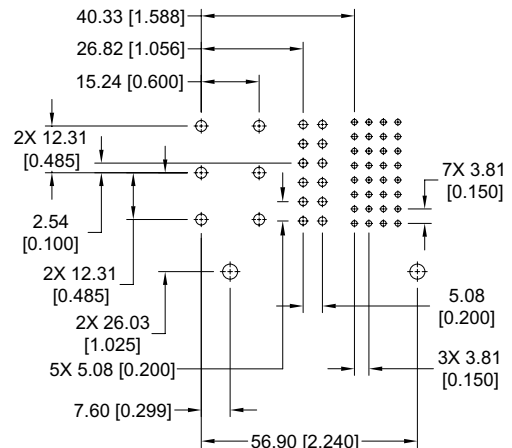

MALE CONNECTOR

Typical Part Number
SUM10M0000

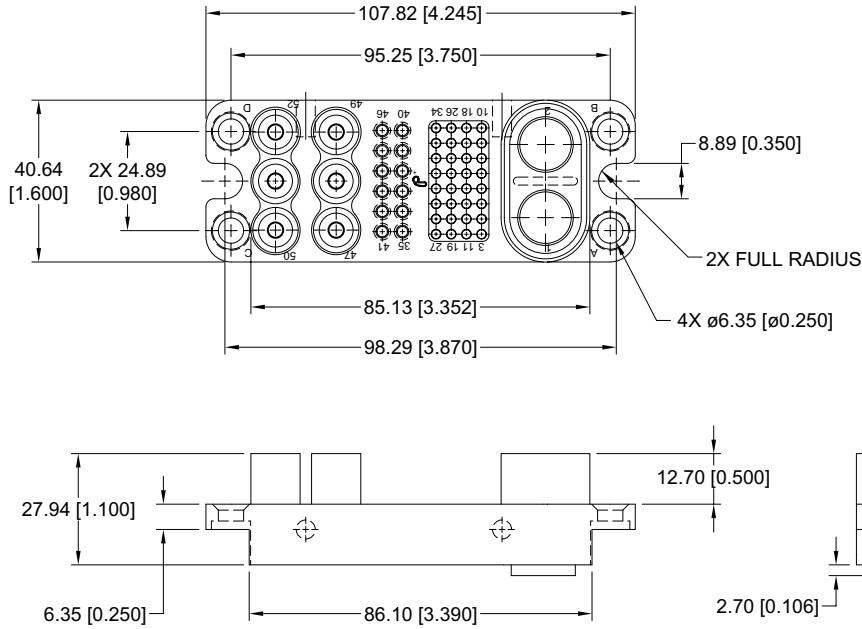

FEMALE CONNECTOR

Typical Part Number
SUM10F0000

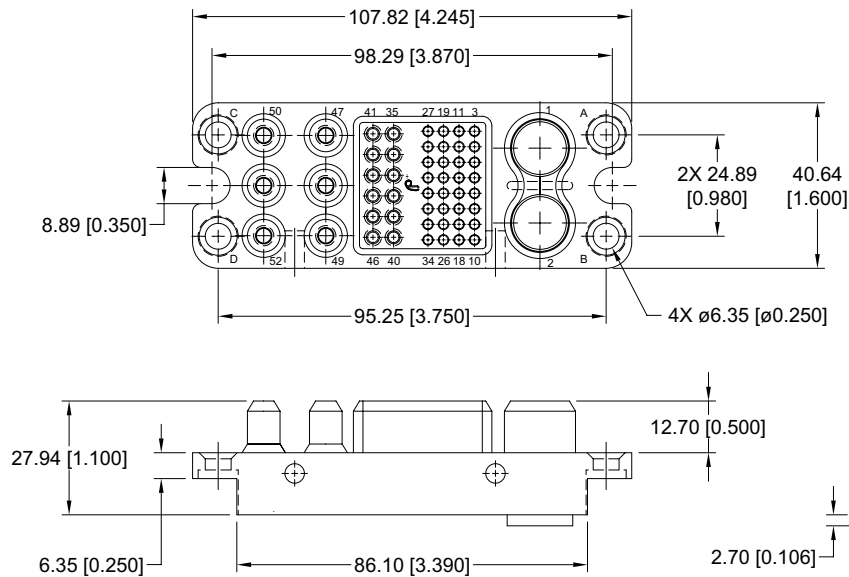



FLOAT MOUNT

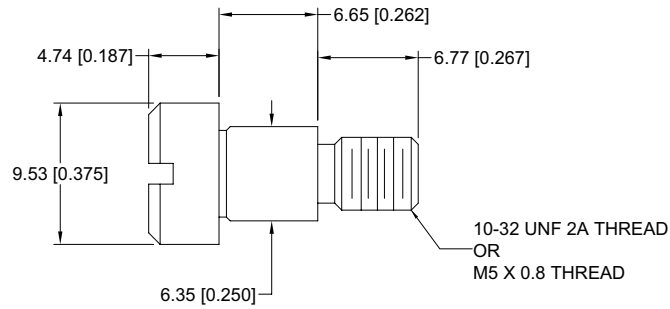

PANEL CUTOUT

MAXIMUM PANEL THICKNESS 4.76 [0.188]

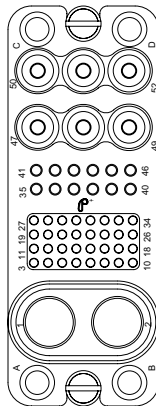
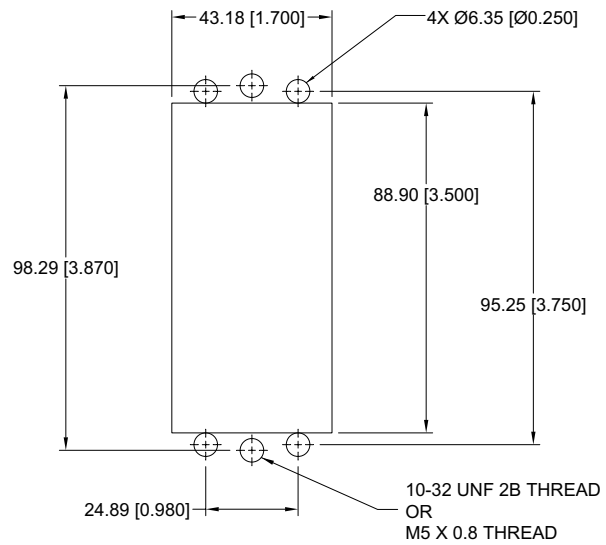

SUM10M0FS00
SHOWN FOR REFERENCE

MOUNTING OPTION

BLIND MATING SYSTEM

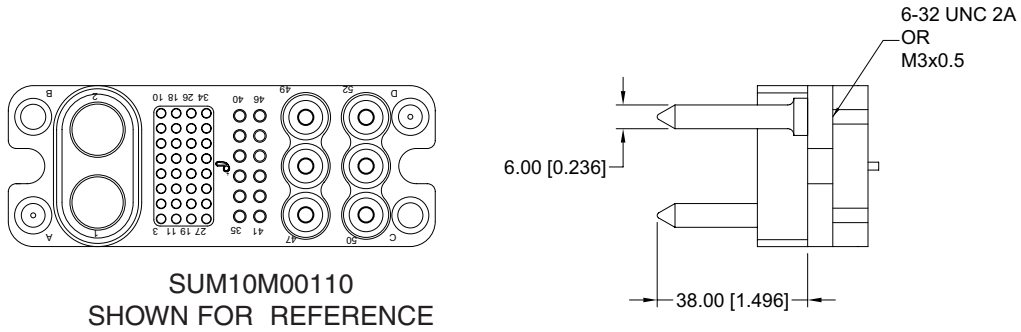

PANEL CUTOUT

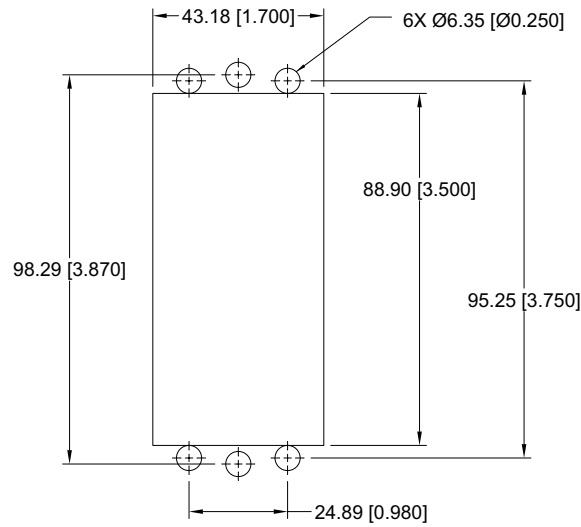

SEQUENTIAL MATING

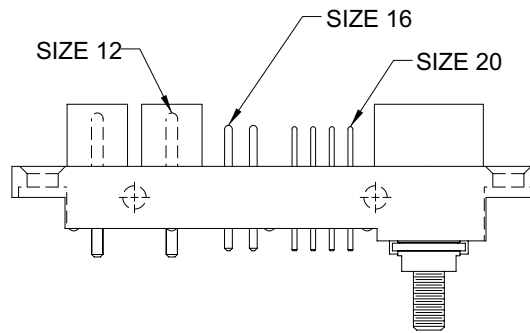

CONTACT SIZE	FIRST MATE	STANDARD	LAST MATE
Size 12	11.68 [0.460]	10.92 [0.430]	9.90 [0.390]
Size 16	12.19 [0.480]	8.38 [0.330]	7.36 [0.290]
Size 20	11.93 [0.470]	8.12 [0.320]	6.85 [0.270]



SIZE 12, 16 AND 20 REMOVABLE CRIMP CONTACTS

Contacts are rear insertion front release style

SIZE 12

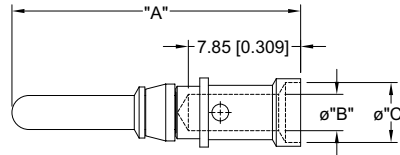

PART NUMBER	WIRE SIZE mm ² [AWG]	A	øB	øC	SEQUENTIAL MATE
SMC1210AN	5.3 [10]	23.46 [0.924]	N/A	3.73 [0.147]	FIRST
SMC1210BN	5.3 [10]	22.70 [0.894]	N/A	3.73 [0.147]	STANDARD
SMC1210CN	5.3 [10]	21.68 [0.854]	N/A	3.73 [0.147]	THIRD
SMC1212AN	4.0 [12]	23.46 [0.924]	2.54 [0.100]	4.19 [0.165]	FIRST
SMC1212BN	4.0 [12]	22.70 [0.894]	2.54 [0.100]	4.19 [0.165]	STANDARD
SMC1212CN	4.0 [12]	21.68 [0.854]	2.54 [0.100]	4.19 [0.165]	THIRD

SIZE 16

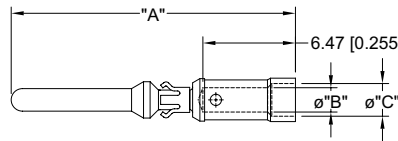

PART NUMBER	WIRE SIZE mm ² [AWG]	A	øB	øC	SEQUENTIAL MATE
SMC1612AN	4.0 [12]	23.68 [0.932]	N/A	2.49 [0.098]	FIRST
SMC1612BN	4.0 [12]	19.87 [0.782]	N/A	2.49 [0.098]	STANDARD
SMC1612CN	4.0 [12]	18.85 [0.742]	N/A	2.49 [0.098]	THIRD
SMC1614AN	2.5 [14]	23.68 [0.932]	2.06 [0.081]	2.67 [0.105]	FIRST
SMC1614BN	2.5 [14]	19.87 [0.782]	2.06 [0.081]	2.67 [0.105]	STANDARD
SMC1614CN	2.5 [14]	18.85 [0.742]	2.06 [0.081]	2.67 [0.105]	THIRD
SMC1616AN	1.5 [16]	23.68 [0.932]	1.70 [0.067]	2.36 [0.093]	FIRST
SMC1616BN	1.5 [16]	19.87 [0.782]	1.70 [0.067]	2.36 [0.093]	STANDARD
SMC1616CN	1.5 [16]	18.85 [0.742]	1.70 [0.067]	2.36 [0.093]	THIRD
SMC1620AN	0.5 [20]	23.68 [0.932]	1.14 [0.045]	1.73 [0.068]	FIRST
SMC1620BN	0.5 [20]	19.87 [0.782]	1.14 [0.045]	1.73 [0.068]	STANDARD
SMC1620CN	0.5 [20]	18.85 [0.742]	1.14 [0.045]	1.73 [0.068]	THIRD

SIZE 20

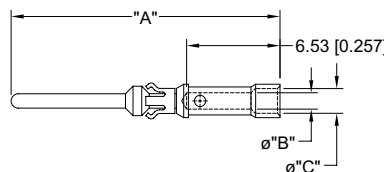

PART NUMBER	WIRE SIZE mm ² [AWG]	A	øB	øC	SEQUENTIAL MATE
SMC2020AN	0.5 [20]	23.93 [0.942]	1.14 [0.045]	1.73 [0.068]	FIRST
SMC2020BN	0.5 [20]	20.12 [0.792]	1.14 [0.045]	1.73 [0.068]	STANDARD
SMC2020CN	0.5 [20]	18.80 [0.740]	1.14 [0.045]	1.73 [0.068]	THIRD

MATERIALS:

Contacts: Copper Alloy.
Retention Clips: Beryllium copper.

FINISH:

Gold flash over nickel plate.

SIZE 12, 16 AND 20 REMOVABLE CRIMP CONTACTS

Contacts are rear insertion front release style

SIZE 12

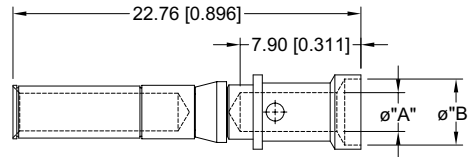

PART NUMBER	WIRE SIZE mm ² [AWG]	øA	øB
SFC1210N2	5.3 [10]	3.73 [0.147]	N/A
SFC1212N2	4.0 [12]	2.54 [0.100]	4.19 [0.165]

SIZE 16

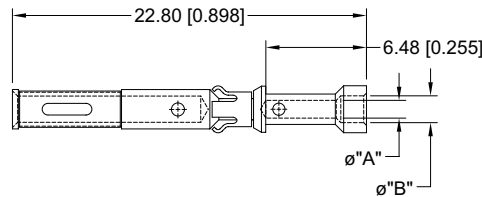

PART NUMBER	WIRE SIZE mm ² [AWG]	øA	øB
SFC1612N2	4.0 [12]	N/A	2.49 [0.098]
SFC1614N2	2.5 [14]	2.06 [0.081]	2.64 [0.104]
SFC1616N2	1.5 [16]	1.70 [0.067]	2.36 [0.093]
SFC1620N2	0.5 [20]	1.14 [0.045]	1.73 [0.068]

SIZE 20

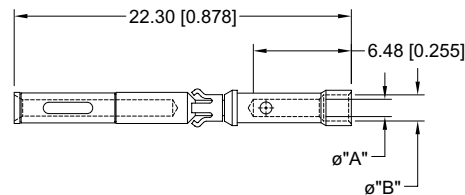

PART NUMBER	WIRE SIZE mm ² [AWG]	øA	øB
SFC2020N2	0.5 [20]	1.14 [0.045]	1.73 [0.068]

MATERIALS:

Contacts: Copper Alloy.
Retention Clips: Beryllium copper.

FINISH:

Gold flash over nickel plate.

DIMENSIONS ARE IN MILLIMETERS [INCHES].
ALL DIMENSIONS ARE SUBJECT TO CHANGE.



SIZE 1/0 REMOVABLE CRIMP CONTACTS

MALE CONTACTS

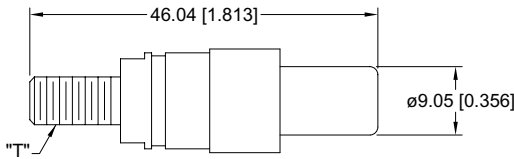

PART NUMBER	"T" Thread
SMET10S	1/4-20 UNC 2A
SMET10M	M6 X 1

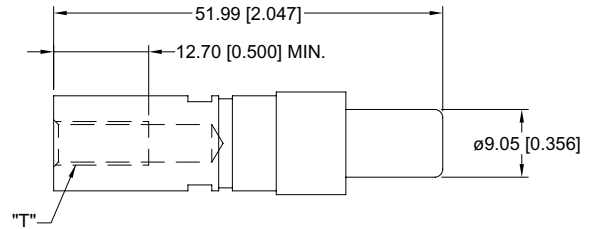

PART NUMBER	"T" Thread
SMIT10S	1/4-20 UNC 2A
SMIT10M	M6 X 1

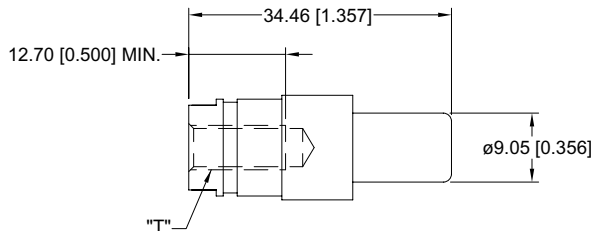

PART NUMBER	"T" Thread
SMSIT10S	1/4-20 UNC 2A
SMSIT10M	M6 X 1

FEMALE CONTACTS

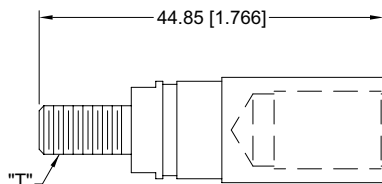

PART NUMBER	"T" Thread
SFET10S	1/4-20 UNC 2A
SFET10M	M6 X 1

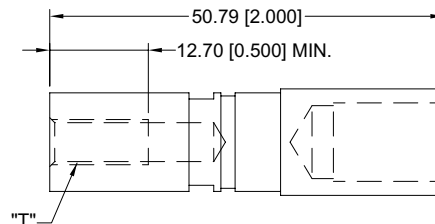

PART NUMBER	"T" Thread
SFIT10S	1/4-20 UNC 2A
SFIT10M	M6 X 1

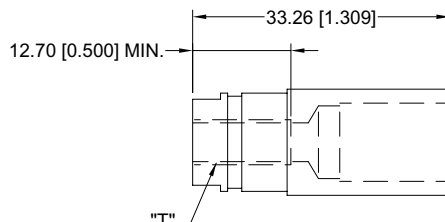

PART NUMBER	"T" Thread
SFSIT10S	1/4-20 UNC 2A
SFSIT10M	M6 X 1

MATERIALS:

Contacts: Copper Alloy.
Retention Clips: Beryllium copper.

FINISH:

Gold flash over nickel plate.



CRIMPING INFORMATION FOR SUMO SERIES CRIMP CONTACTS

Step 1: Strip wire to indicated length.

- Take care not to:
- Damage or remove strands.
 - Untwist or overtwist strands.
 - Leave insulation particles on strands.
 - Damage insulation.

Correctly Stripped Wire:

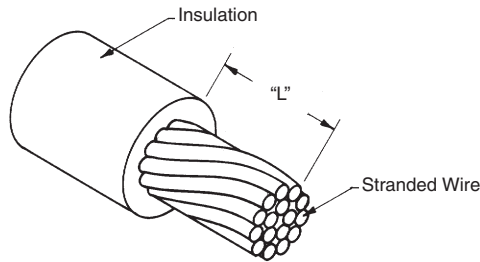

CONTACT SIZE	L ±0.51 [0.020]
12	7.37 [0.290]
16	5.84 [0.230]
20	5.84 [0.230]

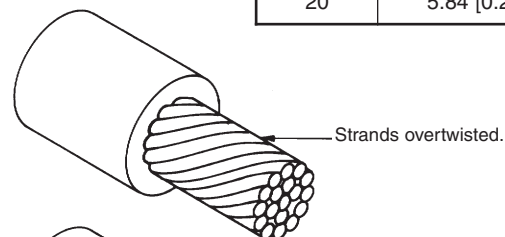
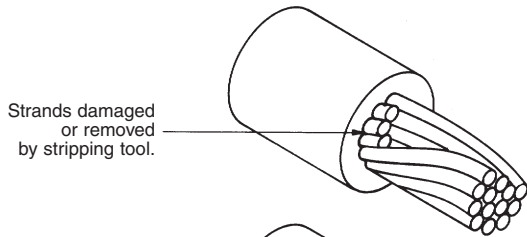

Examples of Stripping Faults

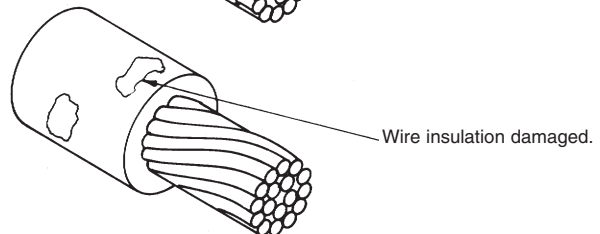
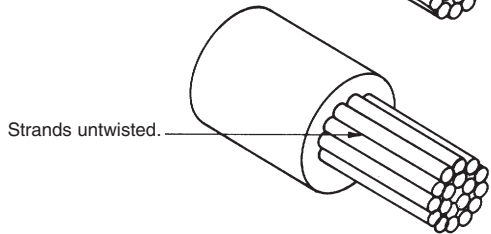
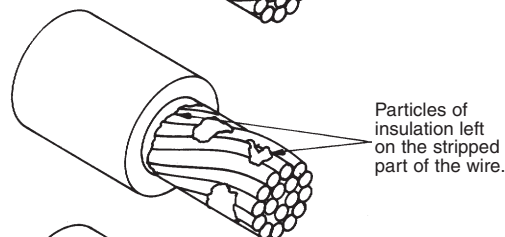
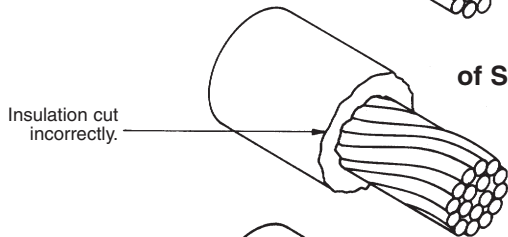

Step 2: Crimp wire to contact.

For Hand Crimp Tool:

- Place contact into crimping tool.
- Insert wire into contact.
- Center contact by slowly closing crimping tool until crimp indenters make contact with crimp barrel.
- Complete the cycle of the crimping tool in one smooth motion.
- Remove the crimped contact.

For Automatic Pneumatic Crimp Tool:

- Insert wire into the contact, positioned in the crimp tool by the plastic carrier.
- Depress the activating device of the crimping tool to start crimping cycle.
- Remove the crimped contact.



CRIMPING INFORMATION FOR SUMO SERIES CRIMP CONTACTS

Step 3: Inspect crimp.

- For All Tools:
- Strands to be visible through the inspection hole.
 - Strands not to be visible beyond the insulation support.
 - Crimped contact to meet recommended conductor tensile force shown in chart (below, left).
 - Check for peeled gold and bent contact.

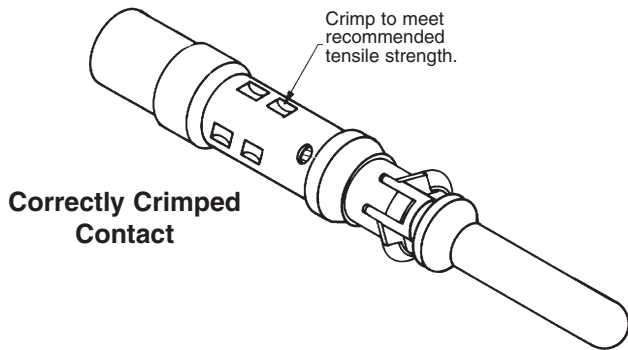

Correctly Crimped Contact

Cross-section of Correctly Crimped Contact

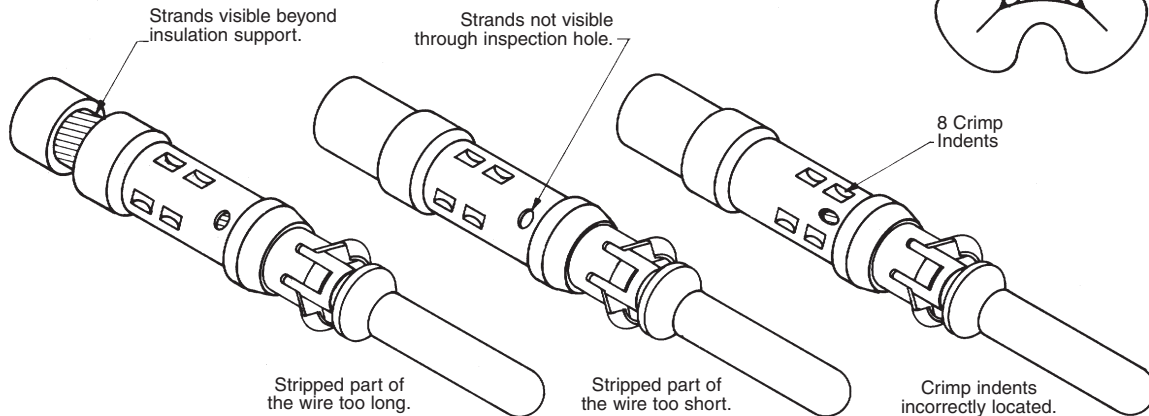
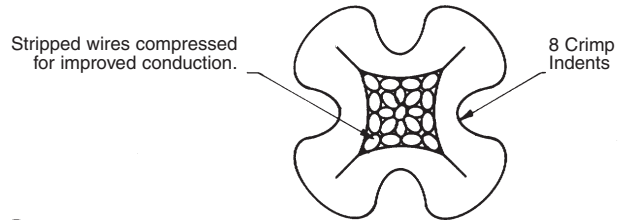

Examples of Crimping Faults

Positronic Recommended Conductor Tensile Strength

WIRE SIZE	AXIAL LOAD
4.0 mm ² [12 AWG]	489N [110 lbs.]
2.5 mm ² [14 AWG]	311N [70 lbs.]
1.5 mm ² [16 AWG]	222N [50 lbs.]
1.0 mm ² [18 AWG]	125N [28 lbs.]
0.5 mm ² [20 AWG]	89N [20 lbs.]
0.3 mm ² [22 AWG]	53N [12 lbs.]
0.25 mm ² [24 AWG]	36N [8 lbs.]
0.12 mm ² [26 AWG]	22N [5 lbs.]

POSITRONIC RECOMMENDED TOOLS

Tool Description	Size 12 Contact	Size 16 Contact	Size 20 Contact
Hand Crimp Tool	9501 with 9502-19-0-0 positioner	9501 with 9502-17-0-0 positioner for Male Contacts 9501 with 9502-26-0-0 positioner for Female Contacts	9507 with 9502-21-0-0 positioner for Male Contacts 9507 with 9502-25-0-0 positioner for Female Contacts
Contact Removal Tool	2711-0-0-0	9081-6-0-0	9081-5-0-0



ORDERING INFORMATION - CODE NUMBERING SYSTEM

Specify Complete Connector By Selecting An Option From Step 1 Through 7

STEP	1	2	3	4	5	6	7	8	9
EXAMPLE	SUM	13	M	6	FS	22	A1	/AA	

STEP 1 - BASIC SERIES

SUM- SUMO Series

STEP 2 - CONNECTOR VARIANTS

- 10 - 52W8 Crimp connector
- 13 - 52W8 Solder, Straight Printed Board Mount
- 14 - 52W8 Solder, Right Angle Printed Board Mount

STEP 3 - CONNECTOR GENDER

- M - Male Insulator
- F - Female Insulator

STEP 4 - CONTACT TERMINATION TYPE

- 0 - No size 0 contacts, ordered separately
- 6 - Size 0 contact with 1/4-20 UNC 2A External Threads
- 7 - Size 0 contact with M6 x 1 External Threads
- 8 - Size 0 contact with 1/4-20 UNC 2A Internal Threads
- 9 - Size 0 contact with M6 x 1 Internal Threads
- 81 - Size 0 contact with 1/4-20 UNC 2A Internal Threads
- 91 - Size 0 contact with M6 x 1 Internal Threads

STEP 5 - MOUNTING STYLE

- 0 - None
- FS - Float Mount Shoulder Screw with 10-32 UNF 2A Threads
- FM - Float Mount Shoulder Screw with M5 x 0.8 Threads
- RS - Inserts with 6-32 UNC 2B Threads, for Right Angle Mounting
- RM - Inserts with M3.5 x 0.5 Threads, for Right Angle Mounting.

STEP 9 - SPECIAL OPTIONS

CONTACT TECHNICAL SALES FOR ORDERING DETAILS OF THE FOLLOWING:
 Select Loading
 Sequential Mating
 Other Special Options

STEP 8 - ENVIRONMENTAL COMPLIANCE OPTIONS

/AA - Compliant per EU Directive 2002/95/EC (RoHS)



NOTE: If compliance to environmental legislation is not required, this step will not be used.
 Example:SUM13M6FS22A1

STEP 7 - CONTACT PLATING

- 0 - Removable Contacts, Ordered Separately
- A1 - Gold flash over nickel on mating end and gold flash over nickel on termination end.
- A2 - Gold flash over nickel on mating end and 5.00 microns [0.000200 inch] solder coat on termination end.
- C1 - 0.80 microns [0.000030 inch] gold over nickel on mating end and 0.80 microns [0.000030 inch] gold over nickel on termination end.
- C2 - 0.80 microns [0.000030 inch] gold over nickel on mating end and 5.00 microns [0.000200 inch] solder coat on termination end.

STEP 6 - BLIND MATE GUIDES

- 0 - No guides
- 11 - 6-32 UNC 2A threaded guides located at positions A and D.
- 12 - M3x0.5 threaded guides located at positions A and D.
- 21 - 6-32 UNC threaded guides located at positions B and C.
- 22 - M3x0.5 threaded guides located at positions B and C.
- 31 - 6-32 UNC 2A threaded guides located at positions A and C.
- 32 - M3x0.5 threaded guides located at positions A and C.
- 41 - 6-32 UNC 2A threaded guides located at positions B and D.
- 42 - M3x0.5 threaded guides located at positions B and D.

NOTE: Once you have made a connector selection, contact Technical Sales if you would like to receive a drawing in DXF, PDF format or a 3-dimensional IGES file.

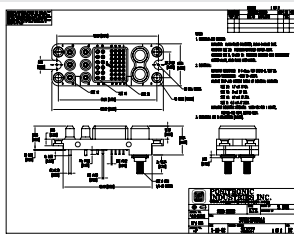

SK Drawing

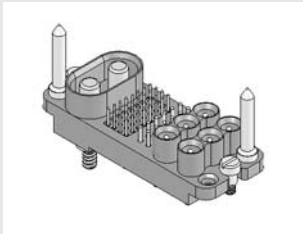

3-dimensional model

POSITRONIC PRODUCTS

Power

Contact Sizes: 0, 8, 12, 16, 20 and 22
Current Ratings: To 150 amperes
Terminations: Crimp, wire solder, straight solder, right angle solder, straight press-fit and right angle press-fit
Configurations: Multiple variants in a variety of package sizes
Compliance: PICMG 2.11, PICMG 3.0, VITA 41

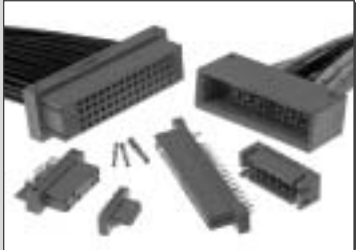

FEATURES: Hot swap capability • AC/DC operation in a single connector • Signal contacts for hardware management • Blind mating • Sequential mating • Large Surface Area Contact Mating System • Wide variety of accessories • Customer specified contact arrangements

D-Subminiature

Contact Sizes: 8, 20 and 22
Current Ratings: To 40 amperes nominal
Terminations: Crimp, wire solder, straight solder, right angle solder and straight press-fit
Configurations: Multiple variants in both standard and high densities
Qualifications: MIL-DTL-24308, Goddard Space Flight 311P, MIL-C-39029, IP65, IP67



FEATURES: Three performance levels available: professional quality, military quality and space-flight quality provide multiple performance to cost choices • Options include thermocouple contacts, filtered, environmentally sealed and dual port package including mixed density • Broad selection of accessories

Rectangular

Contact Sizes: 16, 20 and 22
Current Ratings: To 13 amperes
Terminations: Crimp, wire solder, straight solder and right angle solder
Configurations: Multiple variants in both standard and high densities
Qualifications: MIL-DTL-28748, MIL-C-39029, CCITT V.35



FEATURES: Two performance levels available: industrial quality and military quality provide two performance to cost choices • Large Surface Area Contact Mating System • A wide variety of accessories • Broad selection of contact variants and package sizes

Circular

Contact Sizes: 12, 16, 20 and 22
Current Ratings: To 25 amperes nominal
Terminations: Crimp, wire solder, straight solder and right angle solder
Configurations: Multiple variants in two package sizes
Qualifications: Environmental protection to IP67



FEATURES: Non-corrodible / lightweight composite construction • EMI/RFI shielded versions • Thermocouple contacts • Environmentally sealed versions • Rear insertion/ front release of removable contacts • Two level sequential mating • Overmolding available on full assemblies

Cable

All Positronic connector products can be supplied as part of cable assemblies whose technical characteristics would reflect those of the connectors being used within the assembly.



FEATURES: Shorten the supply chain and reduce additional costs and delays by "cablizing" • Overmolding available • Shielded and environmentally sealed versions available • Power cables and access boxes which meet the SAE J2496 specification

Hermetic

Contact Sizes: 8, 12, 16, 20 and 22
Current Ratings: To 40 amperes nominal
Terminations: Feed through is standard; flying leads and board mount available upon request
Configurations: See D-Subminiature and Circular Configurations above
Qualifications: Space-D32



FEATURES: Intended for use as an electrical feedthrough in high vacuum applications • Leakage rate: 1×10^{-9} mbar.l/s • Signal, power, coax and high voltage versions available • Connectors can be mounted on flange assembly per customer specification

NORTH AMERICAN LOCATIONS

UNITED STATES, Springfield, Missouri, Corporate Headquarters

Factory Sales and Engineering Offices (800) 641-4054

PUERTO RICO, Ponce Factory

Factory Sales and Engineering Offices (800) 641-4054

MEXICO

Factory Sales and Engineering Offices (800) 872-7674

CANADA

Factory Sales and Engineering Offices (800) 327-8272

ASIA/PACIFIC LOCATIONS

SINGAPORE, Asia/Pacific Headquarters

Factory Sales and Engineering Offices (65) 6842-1419

ASIA, Direct Sales Offices

Taiwan Sales Office (88) 62-2937-8775

China Sales Office (86) 755-2643-7578

Korea Sales Office (82) 31-909-8047/8

JAPAN

Sales and Engineering Offices (81) 3-5812-7720

INDIA

Factory Sales and Engineering Offices (91) 20-2439-4810

ASIA/PACIFIC, Technical Agents

Technical Agents in Malaysia, Australia, New Zealand, Philippines,
Hong Kong, Vietnam, Thailand

EUROPEAN LOCATIONS

FRANCE, Auch Factory, European Headquarters

Factory Sales and Engineering Offices 33 (0)5 62 63 44 91

EUROPE, Direct Sales Offices

Northern France Sales Office 33 (0)1 45 88 13 88

Southern France Sales Office 33 (0)4 67 72 80 28

Italy Sales Office 39 (0)2 54 116 106

Northern Germany Sales Office 49 (0)30 34 504 307

Southern Germany Sales Office 49 (0)2351 63 47 39

EUROPE, Technical Agents

Technical Agents in Austria, Benelux, Eastern Europe Countries, Greece,
Ireland, Scandinavia, Spain, Switzerland and the United Kingdom

MIDEAST, Technical Agents

Technical Agents in Israel and Turkey



POSITRONIC INDUSTRIES, INC.

423 N Campbell Ave • PO Box 8247 • Springfield, MO 65801
Tel (417) 866-2322 • Fax (417) 866-4115 • Toll Free (800) 641-4054
info@connectpositronic.com

POSITRONIC INDUSTRIES, S.A.S.

Zone Industrielle d'Engachies • 46 Route d'Engachies
France 32020 Auch Cedex 9
Telephone 33 (0)5 62 63 44 91 • Fax 33 (0)5 62 63 51 17
contact@connectpositronic.com

POSITRONIC ASIA PTE LTD.

3014A Ubi Road 1 #07-01 • Singapore 408703
Telephone (65) 6842 1419 • Fax (65) 6842 1421
singapore@connectpositronic.com