

PROTOTYPING ADAPTERS - BGA UNIVERSAL PROTOTYPING BOARDS

BGA Universal Prototyping Boards make it easy to adapt standard or high-density prototyping boards to a variety of BGA packages.

FEATURES & BENEFITS

- Mountable 0.8mm, 1.0mm, 1.27mm lead pitch BGA/CSP up to 484 pin on 22X22/max
- Able to check all pins at outside holes, printed pin numbers for easy signal location
- Outer holes pitch: 2.54mm
- Solder resist treatment to prevent solder bridge
- Jumper pads available on two sides for custom wiring and additional circuitry
- 0.75mm, & 0.50mm lead pitch boards available upon request

HOW TO ORDER

Please provide the following:

- IC Package Information: Manufacturer & Part Number, Pin Count, and/or Package Outline Drawing
- Prototyping Panel Type
- Determine Top Chip Interface Type: SMT Lands, Solder Tail Pin Receptacles, Production Socket, Zero Insertion Force Socket
- Determine Bottom Terminal Options: Wire Wrap Posts or Solder Tail Pin
- Adapter Application
- Quantity and Delivery Requirements

EMULATION TECHNOLOGY RECOMMENDS

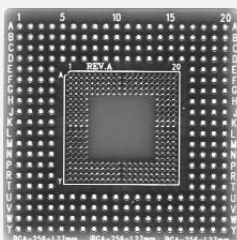

BGA 256 Adapter

Users needing a BGA Surface Mount Adapter can also consider our adapters designed specifically for BGA 256 components. All pads break out to dedicated plated through holes. 1.00mm and 1.27mm lead pitch are available.

Web Link: www.1800adapter.com/001

Try our Chip Quik® SMD Removal Kit

Speeds up SMD removal without requiring expensive equipment or risking the use of heat guns.

Web Link: www.1800adapter.com/046

For a complete list of prototyping adapter specifications, pricing and delivery information, please see:

Web Link: www.1800adapter.com/001

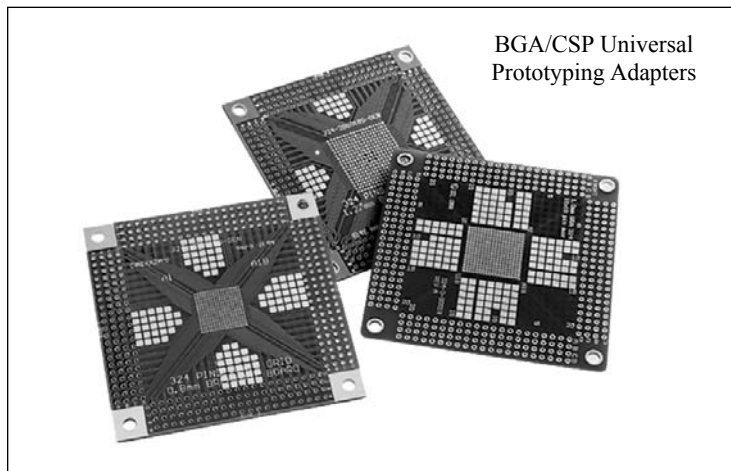

BGA/CSP Universal Prototyping Adapters

Ordering Information Example

Package Code 324-6BG018S-GEN Standard Footprint

Pin Count | Grid Size (Square)

Lead Pitch

2 = 1.27mm 3 = 1.0mm 4 = 0.75mm
5 = .50mm 6 = 0.80mm 7 = 2.54mm

Material Specifications

Package	0.8mm, 1.00mm, 1.27mm Lead Pitch
Material	Glass Epoxy (FR4)
Board Thickness	1.60mm
Copper Plate	Outside: 18mm, inside: 35mm
Plating	Gold Flash
Pin Number	Top side silk print, pin map available
Maximum Current	0.15 A per line

KIT INCLUDES:

- Wire Wrap Post or Screw Machine Pin (available below)
- Prototyping Board
- Pin Map
- 3/4" Standoff (available below)
- Other patterns & sizes available upon request

BGA / CSP

Pin Count	Lead Pitch	BGA Grid Size	Maximum .1" Grid Size	Description	Drawing#
324	0.80mm	SMT 18X18	29X29	324-6BG018S-GEN	F5939
324	1.00mm	SMT 18X18	29X29	324-3BG018S-GEN	F5938
324	1.27mm	SMT 18X18	29X29	324-2BG018S-GEN	F5937
484	1.00mm	SMT 22X22	41X41	484-3BG022S-GEN	F6977
484	0.80mm	SMT 22X22	41X41	484-6BG022S-GEN	F7052
676	1.00mm	SMT 26X26	26X26	676-3BG026S-GEN	F7092
900	1.00mm	SMT 30X30	40X40	900-3BG030S-GEN	F7020
Part #	Document	Description	Qty.		
WWPost-40-PGA	PN1002	Wire Wrap Post - .025# Sq. Post	40 Per Strip		
Header-Male-32	PN1039	Machine Screw Pin .018" Diameter	32 Per Strip		
SPACER	F5784	3/4" Metal Standoff	1 Per		

SMT ADAPTERS/PROTOTYPING PANELS - PROTOTYPING ADAPTERS

PLCC

SMT adapters extend the signals of the following packages to plated through holes on a 100 mil grid: PLCC package's 20, 28, 44, 64 and 84 pin packages and socket families. Ground plane on solder side. (1 EACH)

Board Size: 6.0" X 6.0"

Pad to Pad Spacing: 50 mil

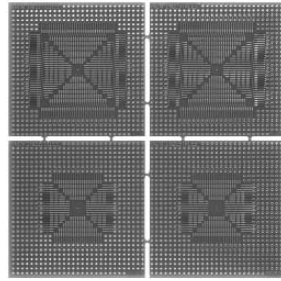

P/N: ET-8100-SMT3

PQFP/TQFP

SMT Adapter for QFP 44, 100 & 160

Pad to Pad Spacing: 25 mil

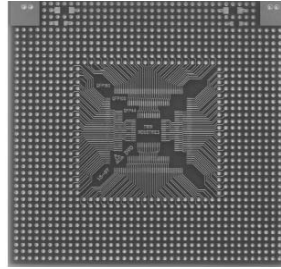

P/N: ET-8100-SMT6

PQFP/TQFP

SMT Adapter for QFP 240 & 208, QFP 144, 128 & 100

Pad to Pad Spacing: 20 mil

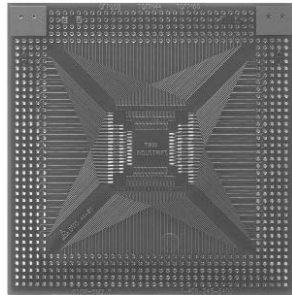

P/N: ET-8100-SMT7

PQFP/TQFP

SMT Adapters for 80 pin QFP packages. 0.50mm Pitch. FR4 Material, Ground plane on rear side.

Board Size: 6.0" X 4.0"

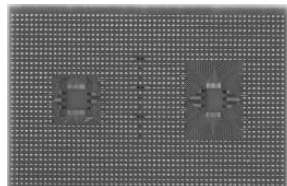

P/N: ET-8100-SMT11

SOIC

SMT adapters extend the signals of the following packages to plated through holes on a 100 mil grid: SOIC medium, wide, metric and plastic mini-flat packages. Ground plane on solder side.

Board Size: 6.0" X 4.0"

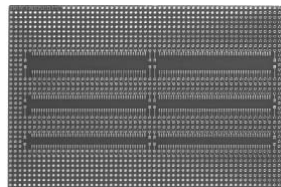

P/N: ET-8100-SMT4

SMT Prototyping Adapter PCBs

FEATURES & BENEFITS

- Access all signals via plated 2.54mm (.100") through-holes, which are numbered for easy signal location. A pin map is included
- Eliminates the need to design-in additional signal access pins/test points
- Also prevents time-consuming board revisions
- Most designs accept several pitch sizes and multiple ICs
See our web site or call ET for detailed layout drawings
- Optional Wire Wrap Post Strips allow mounting on standard Prototyping Panels or universal PCBs
- Solder-resistant treatment helps prevent solder bridging

Popular Package Styles - Call for those not shown:

SOIC 1.27mm, 0.80mm, 0.635mm, 0.65mm, 0.50mm, & 0.40mm pitches

QFP 1.00mm, 0.80mm, 0.635mm, 0.65mm, 0.50mm pitches

PLCC .50" pitch

TSOP 0.550mm & 0.50mm pitches

TSOPII 1.27mm, 1.16mm, 0.80mm, 0.65mm & 0.50mm pitches

MLF 0.80mm, 0.65mm & 0.50mm pitches

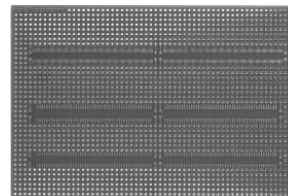

SOIC

SMT Adapter for SOIC Medium, Metric (50 mil Spacing) & Tiny (25 mil Spacing)

P/N: ET-8100-SMT8



TSOP

SMT Adapter for TSOP 40, 48 & 56 (20 mil Spacing), PSOP 44 (50 mil Spacing) & SSOP 56 (30 mil Spacing)

P/N: ET-8100-SMT9

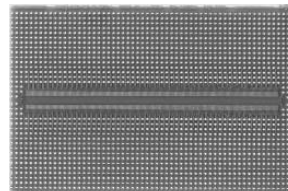

TSSOP

SMT Adapters for TSSOP packages. 0.50mm Pitch. FR4 Material, Ground plane on rear side. Board Size: 6.0"x4.0"

P/N: ET-8100-SMT10

For a complete list of prototyping adapter specifications, pricing and delivery information, please see:
Web Link: www.1800adapter.com/002

PROTOTYPING ADAPTER - PROTOTYPING PANELS / EXTENDERS

PROTOTYPING PANELS

.100" Breadboards / Prototyping Panels

- Available with plated or non-plated thru-holes
- Popular thru-hole sizes: .035", .042", & .062"
- Available with 0, 1, or 2 ground/power planes

Protoboard featuring a 0.1" X 0.1" grid of non-plated through holes.
Board Size: 4.0" X 5.0"

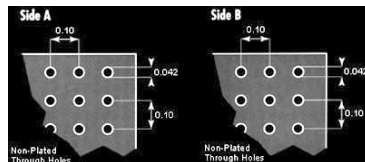

P/N: ET-7100-45

Protoboard featuring a 0.1" X 0.1" grid of non-plated through holes, no plane.
Board Size: 4.0" X 5.0"

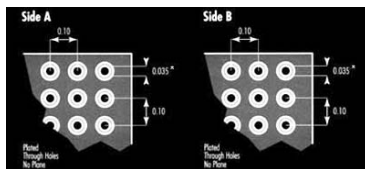

P/N: ET-8000-45

Protoboard featuring a 0.1" X 0.1" grid of non-plated through holes, no plane.
Board Size: 4.0" X 5.0"

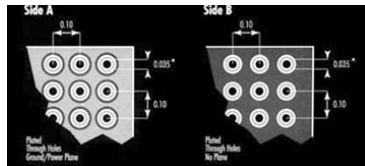

P/N: ET-8100-45

Protoboard featuring a 0.1" X 0.1" grid of plated through holes, two planes.
Board Size: 4.0" X 5.0"

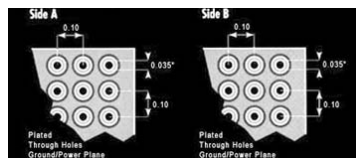

P/N: ET-8200-45

Protoboard featuring a 0.1" x 0.1" grid of non-plated .062" through holes. Board Size: 4.5"

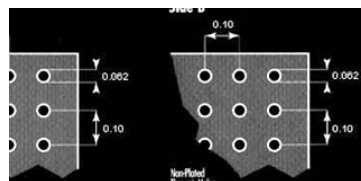

P/N: ET-7100-4565

Protoboard featuring a 2mm x 2mm grid of plated through holes, no plane. Board Size: 100mm x 160mm.

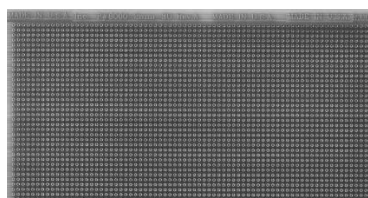

P/N: ET-8000-1060

For a complete list of prototyping panels, pricing and delivery information, please see:

Web Link: www.1800adapter.com/003

EXTENDER CARDS

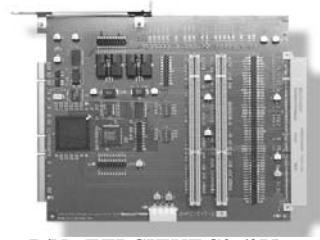

P/N: ETPCIEXT-S3 (3V)
P/N: ETPCIEXT-S5 (5V)

These extender cards are designed to aid in the debug and test of PCI-based circuit boards. This is an active extender card; an Intel® 21154 PCI to PCI bridge is used to isolate the primary PCI bus from the three secondary PCI bus slots. Since primary and secondary

busses are electrically isolated, a much cleaner electrical signaling environment exists, and a single host slot can be expanded to contain up to three plug-in PCI cards. The primary PCI frequency can range from 0 to 66.66 MHz. The secondary PCI frequency is configurable to be the primary frequency or one half the primary frequency. DIP switches are provided to force the primary or secondary buses to 33MHz.

This extender is available in two versions to cover all your voltage-conversion needs:

- 3.3V or 5V to 5V signal conversion.
- 3.3V or 5V to 3.3V signal conversion.



P/N: ET-3300-EXTM

PCMCIA Extender Card with Internal VCC and Ground

- Multi-layer design (4), internal VCC and Ground Planes
- Clearly marked signals for easy probing, grouped for use with multiprobe analyzers
- The ET-3300-EXTM extends the unit under test out of the system for easy access
- The ET-3300-EXTM extends the life of your system by absorbing the wear and tear of multiple insertion environment

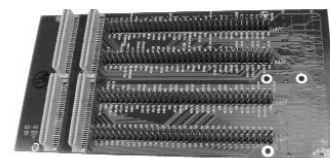

P/N: ET-2500-EXTM

Passive PMC Extender Card

Designed for testing PMC cards on host system or test fixture. J/P 1-4 connectors installed. Labelled 0.1" headers for all signals, allowing analysis with probe or logic analyzer. Keyed for 3.3 and 5 volts. Mounting holes included to allow secure attachment to single board computers.

For a complete list of extender cards, pricing and delivery information, please see:

Web Link: www.1800adapter.com/132

COMPACTPCI EXTENDERS-PROTOTYPING ADAPTER

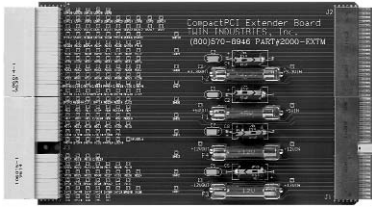

P/N: ET-2000-EXTM

3U CompactPCI extender supports both 32 and 64 Bit transfers. Multi-layer design with full ground and power planes. All power rails fused with standard 3AG fuses.

- 3U CompactPCI extender supports both 32 and 64 bit transfers
- Multi-layer design with full ground and power planes
- Fuses easily removed for current measurements
- All signals labeled for easy scope probing
- All power rails fully de-coupled with both .1uF and 47uF capacitors
- Connectors support full shielding to maintain full CompactPCI compliance

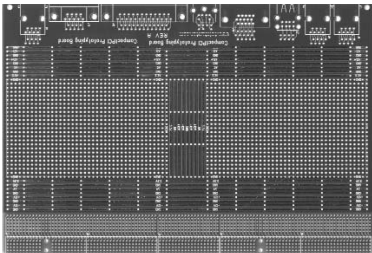

P/N: ET-2000-100-EXTM

CompactPCI prototyping board. 6U form factor with connector mounting areas for J1-5 CompactPCI connectors, RJ45, VGA, USB, PS/2, DB25, and DB9 connectors. Every connector pin has dedicated plated through hole for headers or wire soldering. Bus bars for all voltages and ground. Uncommitted area of 0.1" x 0.1" plated through holes.

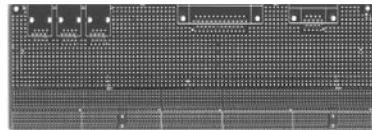

P/N: ET-2000-80-EXTM

6U, 80mm CompactPCI Rear I/O Protoboard. Locations for all CompactPCI pressfit connectors and other commonly used connectors. Bus bars and non-committed prototyping holes on 0.1" x 0.1" grid. Multilayer PCB, FR4 material.

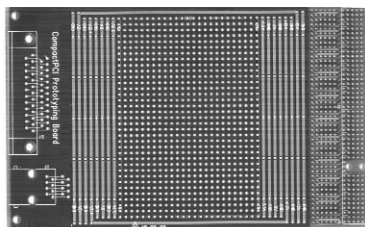

P/N: ET-2000-50-EXTM

3U CompactPCI Protoboard. Locations for all CompactPCI pressfit connectors and other commonly used connectors. Bus bars and non-committed prototyping holes on 0.1" x 0.1" grid. Multilayer PCB, FR4 material.

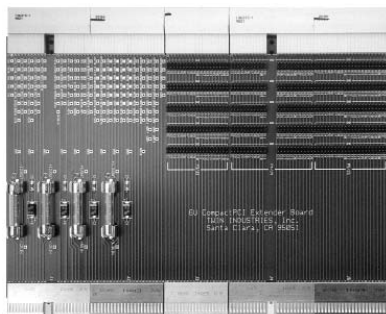

P/N: ET-2000-6U-EXTM

6U CompactPCI extender supports both 32 and 64 Bit transfers. Multi-layer design with full ground and power planes.

- 6U CompactPCI extender supports both 32 and 64 bit transfers
- Multi-layer design with full ground and power planes
- All power rails fused with standard 3AG fuses
- Fuses easily removed for current measurements
- All signals labeled fore easy scope probing
- All power rails fully decoupled with both .1uF and 47uF capacitors
- Connectors support full shielding to maintain full CompactPCI compliance
- Direct connect interface for logic analyzer

For a complete list of prototyping adapters, pricing and delivery information, please see:
Web Link: www.1800adapter.com/004

PROTOTYPING ADAPTER - COMPACTPCI EXTENDERS & PCI CONNECTORS

The ET PCI Test Connector offers the user an accurate and reliable way to test their PCI cards. With over 10,000 reliable cycles, it eliminates the need to constantly replace your PCI Connectors. The Test Connector assembly plugs directly into the PCI connector in the test bed and is actuated by a lever for easy loading and unloading of cards. Available with (PCIZIF120-A) or without (PCIZIF120-C) adapter cards to mate with standard PCI Connectors or a .062" PC board.

FEATURES & BENEFITS

- 10,000 plus cycles
- Mates to 32 Bit 3.3 and 5.0 volt standard PCI connectors
- Available with or without adapter cards to mate with standard PCI Connectors or a .062 PC board
- Custom adapter cards available upon request
- Straddle mount design allows the connector to be terminated to a test designer's own adapter card
- The lever-actuated design allows for quick and easy loading and unloading of PCI cards
- Reduces tester downtime for increased production flow
- Minimal rotation of 40 degrees of the cam accommodates the full open and closed position of the contact

P/N: PCI-ZIF120-ADAPTER

(Adapter & Connector)



P/N: PCI-ZIF120-CONNECTOR

(Connector Only)



Electrical Specifications

Contact Resistance	20 mOhms (max)
Dielectric withstanding voltage	1000 VAC (min)
Insulation Resistance	>1 X 10 12th ohms @ 500VDC
Current Rating	1.0 AMP per contact (continuous)

Mechanical Specifications

Contact Material	Copper alloy
Number of contacts	120
Normal Force	75 grams minimum per contact
Actuation force	1 in/ob of torque
Dielectric material	Glass filled liquid crystal polymer (black)

Environmental

Material	UL rated 94 V-O
Temperature rating	-40 degrees C to +150 degrees C

Lever w/ contacts
in open position

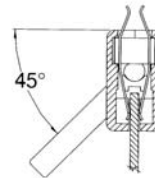

Lever w/ contacts
in closed position

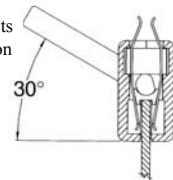

PROTOTYPING ADAPTERS, EXTENDERS & PROTOTYPING BOARDS

3U CompactPCI to 64 bit PCI passive adapter.



P/N: ET-2000-64PCI

3U CompactPCI to 64 bit PCI passive adapter with full size PCI bracket for additional support of Unit Under Test (UUT).



P/N: ET-2002-64PCI

For a complete list of prototyping adapters, pricing and delivery information, please see:

Web Link: www.1800adapter.com/004

PCI BUS EXTENDER CARD CONNECTORS - PROTOTYPING ADAPTER

PN: ET-101913-003



↑
64 Bit 5V PCI Connector mounted to
PCI Bus Extender Card.

PN: ET-102639-001

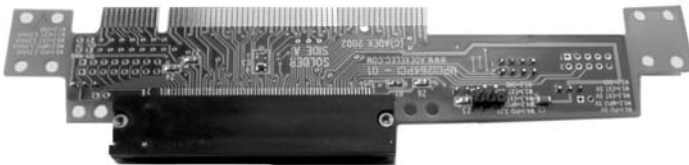

↑
mini PCI Connector mounted to
Intel PCI Bus Extender Card.*

* mini PCI Connectors can be mounted for other manufacturers' PCI Bus Extender Cards/

Contact Specifications	
Self Inductance	5.2nh < 500 MHZ
Mutual Inductance	< .75 db @ 1 GHz
Ground Capacitance	< .87 pf
Mutual Capacitance	< .71 pf
Current	3 Amp Continuous
Height	13 mm (0.79")
Force	20-30 g/contact
Typical Life	20-50K insertions
Composition and Plating Specifications	
Contact Base Material	Beryllium copper with ~ 150 μ in electroless NI and ~35-50 μ in hard alloy AU
Housing and Frame Specifications	
Material	30% Glass filled Torlon 5030, Ultem 2300, LCP

The specifications for these cards is preliminary. Performance will vary based on application and compliance requirements.

DESIGNED AS A DROP IN REPLACEMENT FOR STANDARD EXTENDER CARDS

These LIF Edge Cards are standardized, low-cost, high insertion count designs that provide an alternative to customized, high-priced, long-lead-time connectors, or low cost short insertion life commercial connectors with high insertion forces. These contacting systems are available for a wide range of standard package sizes and I/O counts and provide significant benefits to the user.

These Edge Cards are specifically designed for PCI devices with the following characteristics:

- Low Insertion Force
- Long Mechanical Life
- Straddle Mount
- Solder attach or Solder-less versions
- Replaceable Keys

Mounting these LIF (Low Insertion Force) connectors to PCI Bus Extender Cards enables them to be plugged directly into a standard commercial PCI connector.

FEATURES & BENEFITS

- Pre-designed footprints for standard-dimensioned packages shorten manufacturing lead times
- The standard designs reduce costs associated with custom engineering
- Connectors are quickly and easily changed
- Cost effective solution for development, debugging, test qualification or evaluation
- Topside decoupling pockets allow close decoupling, reducing ground bounce and overshoot
- Solderless or solder down, SMT inserts can easily and rapidly be changed reducing costs associated with board and device work
- Available for in 3V or 5V
- 32-bit PCI available

NOTE: 2 piece minimum order required for both PCI extender cards.

For a additional information, specifications, pricing and delivery information, please see:

Web Link: www.1800adapter.com/004

PROTOTYPING ADAPTERS - FULLY ASSEMBLED & TESTED

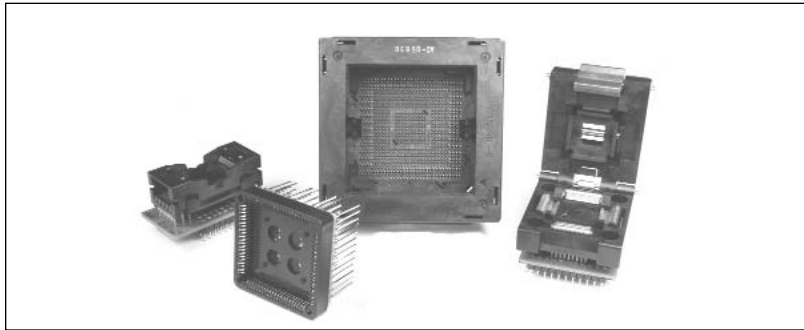

Ordering Information Example

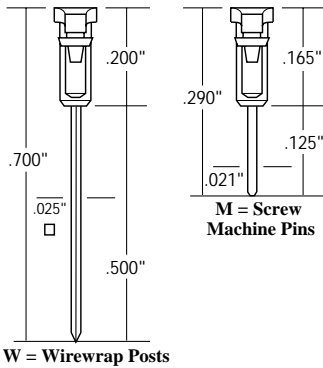
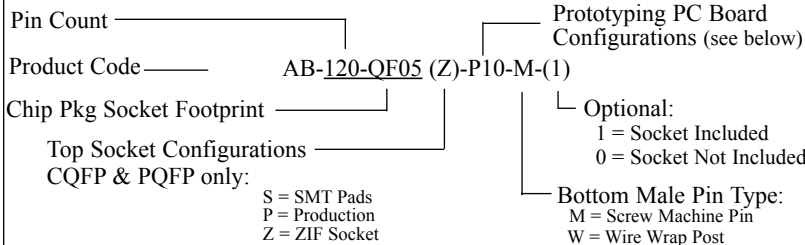

M - Machine screw version
Adapt-A-Boards are used on prototyping boards that have wire wrap posts already installed on the back side of the prototyping board. The pins on the back of these Adapt-A-Boards plug directly into these posts.

W - Wire-wrappable Adapt-A-Boards
Adapt-A-Boards are used in prototyping boards that have holes with nothing in them. The wire-wrap posts go through the holes and can then be wire-wrapped on the back side of the board.

Adapt-A-Boards make it easy to adapt standard or high-density prototyping boards to a variety of packages including BGA, PLCC,PGA, PQFP, SOIC and more...

FEATURES & BENEFITS

- Bottom configurations adapt to wire wraps or screw machine pins
- Over 300 varieties available
- Pins conform to MIL-C-45204
- Pins and sockets are gold plated; 10 u gold over 100 u nickel
- Available in standard sizes or custom designs.

HOW TO ORDER

- 1) Determine your board configuration using the diagrams on this page (type A, B, C, or P)
- 2) Determine if you need a machine screw pins (M) or wire wrap (W) post version (see Bottom Male Pin Types below)
- 3) Determine your IC package type and locate it on the following pages
- 4) Determine your pin count

EMULATION TECHNOLOGY RECOMMENDS:

Safely handle your fine-pitch devices with a product from Emulation Technology's Vacuum handling systems.

Vacuum Pens

ET's vacuum pens are hand-held, manually operated handling tools that allow you to lift and move fine pitch devices.



- Easily lift ICs without damaging device
- Eliminates need to touch fragile packages
- Built-in vacuum
- All pens come with tips

For a complete list of vacuum specifications, pricing and delivery information, please see:

Web Link: www.1800adapter.com/086

Prototyping PC Board Configurations

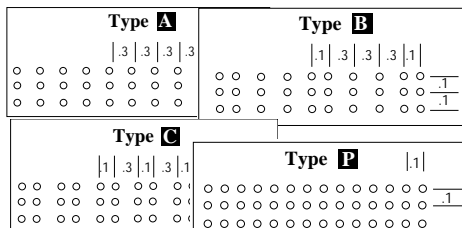

P5= PGA 8X8	P10= PGA 17X17	P19= PGA 26X26
P6= PGA 9X9	P11= PGA 18X18	P20= PGA 27x27
P2= PGA 10X10	P12= PGA 19X19	P21= PGA 28X28
P1= PGA 11X11	P13= PGA 20X20	P22= PGA 29x29
P7= PGA 12X12	P14= PGA 21X21	P23= PGA 30X30
P3= PGA 13X13	P15= PGA 22X22	P24= PGA 31X31
P8= PGA 14X14	P16= PGA 23X23	P25= PGA 32X32
P4= PGA 15X15	P17= PGA 24X24	P26= PGA 33x33
P9= PGA 16X16	P18= PGA 25X25	P27= PGA 34x34

For a complete list of prototyping adapters, pricing and delivery information, please see:

Web Link: www.1800adapter.com/004

FULLY ASSEMBLED & TESTED - PROTOTYPING ADAPTERS

Ordering Information Example

Pin Count _____ Prototyping PC Board Configurations (see below)

Product Code _____ AB-120-QF05 (Z)-P10-M-(1)

Chip Pkg Socket Footprint _____

Top Socket Configurations _____

CQFP & PQFP only:

S = SMT Pads
P = Production
Z = ZIF Socket

Optional:
1 = Socket Included
0 = Socket Not Included

Bottom Male Pin Type:
M = Screw Machine Pin
W = Wire Wrap Post

For a complete list of prototyping adapter specifications, pricing and delivery information, please see

Web Link: www.1800adapter.com/004

Prototyping PC Board Configurations

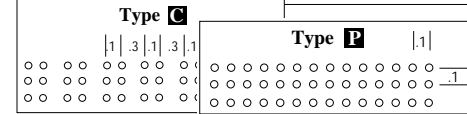
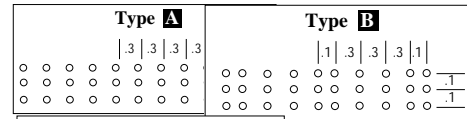

- | | | |
|---------------|----------------|----------------|
| P5= PGA 8X8 | P10= PGA 17X17 | P19= PGA 26X26 |
| P6= PGA 9X9 | P11= PGA 18X18 | P20= PGA 27x27 |
| P2= PGA 10X10 | P12= PGA 19X19 | P21= PGA 28X28 |
| P1= PGA 11X11 | P13= PGA 20X20 | P22= PGA 29x29 |
| P7= PGA 12X12 | P14= PGA 21X21 | P23= PGA 30X30 |
| P3= PGA 13X13 | P15= PGA 22X22 | P24= PGA 31X31 |
| P8= PGA 14X14 | P16= PGA 23X23 | P25= PGA 32X32 |
| P4= PGA 15X15 | P17= PGA 24X24 | P26= PGA 33x33 |
| P9= PGA 16X16 | P18= PGA 25X25 | P27= PGA 34x34 |

BGA / CSP

Pin Count	Lead Pitch (mm)	Adapter Top Female Config.	Adapter Bottom Male Config.	Pin Type	ET Part #	Drawing #
40	0.75	Surface Mount	P5	Screw Machine	AB-040-4BG5X8S-P5-M	F5362
40	0.75	Surface Mount	P5	Wire Wrap	AB-040-4BG5X8S-P5-W	F5363
48	0.75	Surface Mount	P5	Screw Machine	AB-048-4BG6X8S-P5-M	F5353
48	0.75	Surface Mount	P5	Wire Wrap	AB-048-4BG6X8S-P5-W	F5364
56	0.75	Surface Mount	P5	Screw Machine	AB-056-4BG9X8S-P5-M	F5360
56	0.75	Surface Mount	P5	Wire Wrap	AB-056-4BG9X8S-P5-W	F5361
60	0.75	Zero Insertion Socket	A	Screw Machine	AB-060-4BG11X8Z-A-M	F3057
60	0.75	Zero Insertion Socket	A	Wire Wrap	AB-060-4BG11X8Z-A-W	F2676
144	0.80	Zero Insertion Socket	P25	Screw Machine	AB-144-6BG013Z-P25-M-1	F6758
144	0.80	Zero Insertion Socket	P25	Wire Wrap	AB-144-6BG013Z-P25-W-1	F6755
168	1.27	Zero Insertion Socket	P3	Screw Machine	AB-0168-2BG016Z-P3-M-1	F4755
196	1.00	Surface Mount	P13	Screw Machine	AB-0196-3BG014S-P13-M	F6803
223	1.00	Surface Mount	P11	Screw Machine	AB-0223-3BG018S-P11-M	F6845
223	1.00	Zero Insertion Socket	P11	Screw Machine	AB-0223-3BG018Z-P11-M-1	F6706
256	1.27	Surface Mount	P9	Screw Machine	AB-0256-2BG016S-P9-M	F5318
256	1.27	Zero Insertion Socket	P9	Screw Machine	AB-0256-2BG016Z-P9-M-1	F5810
256	1.27	Zero Insertion Socket	P9	Wire Wrap	AB-0256-2BG016Z-P9-W-1	F6179
256	1.27	Production Socket	P9	Screw Machine	AB-0256-2BG020P-P9-M-1	F4222
256	1.27	Production Socket	P9	Wire Wrap	AB-0256-2BG020P-P9-W-1	F4415
256	1.27	Surface Mount	P9	Screw Machine	AB-0256-2BG020S-P9-M	F4439
256	1.27	Zero Insertion Socket	P9	Screw Machine	AB-0256-2BG020Z-P9-M-1	F4222
256	1.27	Zero Insertion Socket	P9	Wire Wrap	AB-0256-2BG020Z-P9-W-1	F4415
256	1.00	Zero Insertion Socket	P13	Screw Machine	AB-0256-3BG016Z-P13-M-1	F5342
256	1.00	Zero Insertion Socket	P13	Wire Wrap	AB-0256-3BG016Z-P13-W-1	F6847
272	1.27	Zero Insertion Socket	P10	Screw Machine	AB-0272-2BG020Z-P10-M-1	F5032
304	1.27	Production Socket	P11	Screw Machine	AB-0304-2BG023P-P11-M-1	F5064
304	1.27	Zero Insertion Socket	P11	Wire Wrap	AB-0304-2BG023Z-P11-W-1	F6244
352	1.27	Zero Insertion Socket	P19	Screw Machine	AB-0352-2BG026Z-P19-M-1	F5547
357	1.27	Production Socket	P13	Screw Machine	AB-0357-2BG019P-P13-M-1	F5446
361	1.27	Zero Insertion Socket	P12	Screw Machine	AB-0361-2BG019Z-P12-M-1	F5028
388	1.27	Production Socket	P14	Screw Machine	AB-0388-2BG026P-P14-M-1	F5158
400	1.27	Zero Insertion Socket	P13	Screw Machine	AB-0400-2BG020Z-P13-M-1	F5103
432	1.27	Zero Insertion Socket	P14	Screw Machine	AB-0432-2BG031Z-P14-M-1	35708
441	1.27	Zero Insertion Socket	P14	Screw Machine	AB-0441-2BG027Z-P14-M-1	F4448
456	1.27	Production Socket	P15	Screw Machine	AB-0456-2BG026P-P15-M-1	F6018
456	1.27	Production Socket	P15	Wire Wrap	AB-0456-2BG026P-P15-W-1	F4504
456	1.27	Zero Insertion Socket	P15	Wire Wrap	AB-0456-2BG026Z-P15-W-1	F6709
560	1.27	Zero Insertion Socket	P42	Screw Machine	AB-0560-2BG033Z-P42-M-1	F6296
600	1.27	Zero Insertion Socket	P20	Screw Machine	AB-0600-2BG035Z-P20-M-1	F5478
600	1.27	Zero Insertion Socket	P20	Wire Wrap	AB-0600-2BG035Z-P20-W-1	F5477
625	1.27	Zero Insertion Socket	P18	Screw Machine	AB-0625-2BG025Z-P18-M-1	F5324
652	1.27	Zero Insertion Socket	P50	Screw Machine	AB-0652-2BG035Z-P50-M-1	F6354
652	1.27	Zero Insertion Socket	P50	Wire Wrap	AB-0652-2BG035Z-P50-W-1	F6355
672	1.00	Production Socket	P21	Screw Machine	AB-0672-3BG026P-P21-M-1	F5511

For a complete list of prototyping adapters, pricing and delivery information, please see:

Web Link: www.1800adapter.com/004

PROTOTYPING ADAPTERS - FULLY ASSEMBLED & TESTED

Prototyping PC Board Configurations

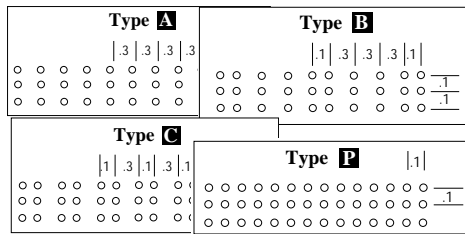

P5= PGA 8X8	P10= PGA 17X17	P19= PGA 26X26
P6= PGA 9X9	P11= PGA 18X18	P20= PGA 27x27
P2= PGA 10X10	P12= PGA 19X19	P21= PGA 28X28
P1= PGA 11X11	P13= PGA 20X20	P22= PGA 29x29
P7= PGA 12X12	P14= PGA 21X21	P23= PGA 30X30
P3= PGA 13X13	P15= PGA 22X22	P24= PGA 31X31
P8= PGA 14X14	P16= PGA 23X23	P25= PGA 32X32
P4= PGA 15X15	P17= PGA 24X24	P26= PGA 33x33
P9= PGA 16X16	P18= PGA 25X25	P27= PGA 34x34

Ordering Information Example

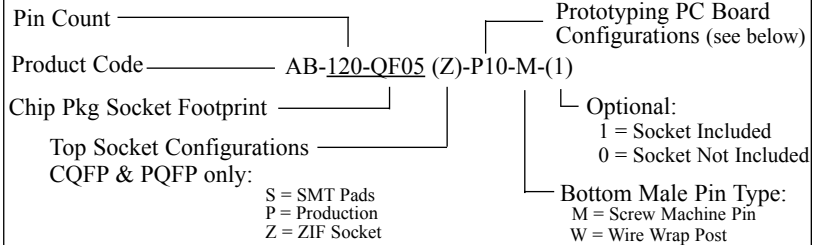

For a complete list of prototyping adapter specifications, pricing and delivery information, please see

Web Link: www.1800adapter.com/004

PQFP/TQFP

Pin Count	Lead Pitch (mm)	Tip-to-Tip mm (sq.)	Adapter Top Female Configuration	Bottom Pin Type	Bottom Configuration Type	Adapter Bottom Male Configuration	ET Part #	Drawing #
32	0.80	9.00	Zero Insertion Socket	Screw Machine	Q16	A	AB-032-QF59DZ-A-M	F4000
32	0.80	9.00	Zero Insertion Socket	Wire Wrap	Q16	A	AB-032-QF59DZ-A-W	F6017
44	0.80	12.00 - 13.90	Surface Mount	Wire Wrap	Q16	A & B	AB-044-QF16S-A/B-W	F2691
44	0.80	12.00 - 13.90	Surface Mount	Screw Machine	Q16	C	AB-044-QF16S-C-M	F2692
44	0.80	12.00 - 13.90	Surface Mount	Wire Wrap	Q16	C	AB-044-QF16S-C-W	F2693
44	0.80	12.00 - 13.90	Surface Mount	Screw Machine	Q16	8X8 PGA Grid	AB-044-QF16S-P5-M	F2694
44	0.80	12.00 - 13.90	Surface Mount	Wire Wrap	Q16	8X8 PGA Grid	AB-044-QF16S-P5-W	F2695
44	0.80	13.20 - 13.90	Zero Insertion Socket	Screw Machine	Q16A/B	8X8 PGA Grid	AB-044-QF16A/BZ-P5-M-1	F2700
44	0.80	13.20 - 13.90	Zero Insertion Socket	Wire Wrap	Q16A/B	8X8 PGA Grid	AB-044-QF16A/BZ-P5-W-1	F2701
44	0.80	12.00 - 13.90	Surface Mount	Screw Machine	Q16	A & B	AB-044-QF16S-A/B-M	F2690
44	0.80	13.20	Zero Insertion Socket	Screw Machine	Q16B	A	AB-044-QF16BZ-A-M-1	F2697
44	0.80	13.20	Zero Insertion Socket	Wire Wrap	Q16B	A	AB-044-QF16BZ-A-W-1	F2699
44	0.80	12.60	Zero Insertion Socket	Screw Machine	Q16C	11X11 PGA Grid	AB-044-QF16CZ-P1-M-1	F4418
44	0.80	12.60	Zero Insertion Socket	Wire Wrap	Q16C	11X11 PGA Grid	AB-044-QF16CZ-P1-W-1	F4420
44	0.80	12.60	Zero Insertion Socket	Wire Wrap	Q16C	11X11 PGA Grid	AB-044-QF16CZ-P1-W-1	F4420
44	0.80	12.00	Zero Insertion Socket	Screw Machine	Q16D	8X8 PGA Grid	AB-044-QF16DZ-P5-M-1	F5793
44	0.80	12.00	Zero Insertion Socket	Wire Wrap	Q16D	8X8 PGA Grid	AB-044-QF16DZ-P5-W-1	F59F4
48	0.50	9.00 - 10.90	Surface Mount	Screw Machine	Q50	C	AB-048-QF50S-C-M	F4188
48	0.50	9.00 - 10.90	Surface Mount	Wire Wrap	Q50	C	AB-048-QF50S-C-W	F4505
48	0.50	9.00	Zero Insertion Socket	Screw Machine	50D	C	AB-048-QF50DZ-C-M-1	F5060
48	0.50	9.00	Zero Insertion Socket	Wire Wrap	50D	C	AB-048-QF50DZ-C-W-1	F5061
52	0.65	12.00 - 13.90	Surface Mount	Screw Machine	Q39	9X9 PGA Grid	AB-052-QF39S-P6-M	F1484
52	0.65	12.00 - 13.90	Surface Mount	Wire Wrap	Q39	9X9 PGA Grid	AB-052-QF39S-P6-W	F1483
52	0.65	13.90	Zero Insertion Socket	Screw Machine	Q39A	9X9 PGA Grid	AB-052-QF39AZ-P6-M-1	F4511
52	0.65	13.90	Zero Insertion Socket	Wire Wrap	Q39A	9X9 PGA Grid	AB-052-QF39AZ-P6-W-1	F2725
52	0.65	13.20	Zero Insertion Socket	Screw Machine	Q39B	9X9 PGA Grid	AB-052-QF39BZ-P6-M-1	F5541
52	0.65	13.20	Zero Insertion Socket	Wire Wrap	Q39B	9X9 PGA Grid	AB-052-QF39BZ-P6-W-1	F5542
52	0.65	12.00	Zero Insertion Socket	Screw Machine	Q39D	9X9 PGA Grid	AB-052-QF39DZ-P6-M-1	F4189
52	1.00	16.00 - 17.90	Surface Mount	Screw Machine	Q37	9X9 PGA Grid	AB-052-QF37S-P6-M	F2722
52	1.00	16.00 - 17.90	Surface Mount	Wire Wrap	Q37	9X9 PGA Grid	AB-052-QF37S-P6-W	F2723
52	1.00	16.00	Zero Insertion Socket	Screw Machine	Q37D	10X10 PGA Grid	AB-052-QF37DZ-P2-M-1	F5714
64	0.50	12.00 - 13.90	Surface Mount	Screw Machine	Q64	A	AB-064-QF64S-A-M	F5F13
64	0.50	12.00 - 13.90	Surface Mount	Wire Wrap	Q64	A	AB-064-QF64S-A-W	F6095
64	0.50	23.20/17.20	Surface Mount	Wire Wrap	Q9B	15X15 PGA Grid	AB-064-QF09BZ-P4-W-1	F6918
64	0.50	12.00	Zero Insertion Socket	Screw Machine	64D	A	AB-064-QF64DZ-A-M-1	F2748
64	0.50	12.00	Zero Insertion Socket	Wire Wrap	64D	A	AB-064-QF64DZ-A-W-1	F4422
64	0.50	23.20/17.20	Zero Insertion Socket	Screw Machine	Q9B	15X15 PGA Grid	AB-064-QF09BZ-P4-M-1	F2746
64	0.80	16.00 - 17.90	Surface Mount	Screw Machine	Q29	A	AB-064-QF29S-A-M	F3858
64	0.80	16.00 - 17.90	Surface Mount	Wire Wrap	Q29	A	AB-064-QF29S-A-W	F4513
64	0.80	16.00 - 17.90	Surface Mount	Screw Machine	Q29	B	AB-064-QF29S-B-M	F3929
64	0.80	16.00 - 17.90	Surface Mount	Wire Wrap	Q29	B	AB-064-QF29S-B-W	F4514
64	0.80	17.20	Zero Insertion Socket	Screw Machine	Q29B	C	AB-064-QF29BZ-C-M-1	F2747
64	0.80	17.20	Zero Insertion Socket	Wire Wrap	Q29B	C	AB-064-QF29BZ-C-W-1	F4159
64	0.80	16.00	Zero Insertion Socket	Screw Machine	Q29D	C	AB-064-QF29DZ-C-M-1	F4093
64	0.80	16.00	Zero Insertion Socket	Wire Wrap	Q29D	C	AB-064-QF29DZ-C-W-1	F1722
64	1.00	23.20/17.20 - 23.90/17.90	Zero Insertion Socket	Screw Machine	Q9A/B	15X15 PGA Grid	AB-064-QF09A/BZ-P4-M-1	F1726
64	1.00	23.20/17.20 - 23.90/17.90	Zero Insertion Socket	Wire Wrap	Q9A/B	15X15 PGA Grid	AB-064-QF09A/BZ-P4-W-1	F1727
64	1.00	22.00/16.00 - 23.90/17.90	Surface Mount	Screw Machine	Q9	A & B	AB-064-QF09S-A/B-M	F2740
64	1.00	22.00/16.00 - 23.90/17.90	Surface Mount	Wire Wrap	Q9	A & B	AB-064-QF09S-A/B-W	F2741
64	1.00	22.00/16.00 - 23.90/17.90	Surface Mount	Screw Machine	Q9	C	AB-064-QF09S-C-M	F2742

FULLY ASSEMBLED & TESTED - PROTOTYPING ADAPTERS

Ordering Information Example

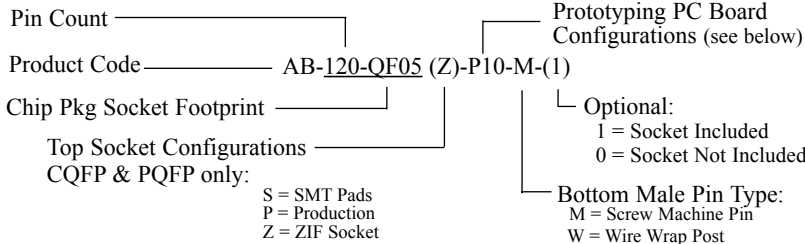

For a complete list of prototyping adapter specifications, pricing and delivery information, please see

Web Link: www.1800adapter.com/004

Prototyping PC Board Configurations

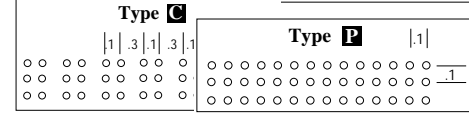
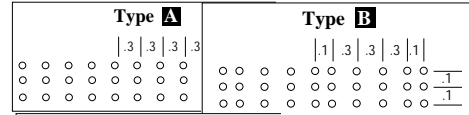

P5= PGA 8X8	P10= PGA 17X17	P19= PGA 26X26
P6= PGA 9X9	P11= PGA 18X18	P20= PGA 27x27
P2= PGA 10X10	P12= PGA 19X19	P21= PGA 28X28
P1= PGA 11X11	P13= PGA 20X20	P22= PGA 29x29
P7= PGA 12X12	P14= PGA 21X21	P23= PGA 30X30
P3= PGA 13X13	P15= PGA 22X22	P24= PGA 31X31
P8= PGA 14X14	P16= PGA 23X23	P25= PGA 32X32
P4= PGA 15X15	P17= PGA 24X24	P26= PGA 33x33
P9= PGA 16X16	P18= PGA 25X25	P27= PGA 34x34

PQFP/TQFP (cont.)

Pin Count	Lead Pitch (mm)	Tip-to-Tip (mm (sq.))	Adapter Top Female Configuration	Bottom Pin Type	Bottom Configuration Type	Adapter Bottom Male Configuration	ET Part #	Drawing #
64	1.00	22.00/16.00 - 23.90/17.90	Surface Mount	Screw Machine	Q9	C	AB-064-QF09S-C-M	F2742
64	1.00	22.00/16.00 - 23.90/17.90	Surface Mount	Wire Wrap	Q9	C	AB-064-QF09S-C-W	F2743
64	1.00	22.00/16.00 - 23.90/17.90	Surface Mount	Screw Machine	Q9	12X12 PGA Grid	AB-064-QF09S-P7-M	F2744
64	1.00	22.00/16.00 - 23.90/17.90	Surface Mount	Wire Wrap	Q9	12X12 PGA Grid	AB-064-QF09S-P7-W	F2745
80	0.50	14.00 - 15.90	Surface Mount	Screw Machine	Q47	11X11 PGA Grid	AB-080-QF47S-P1-M	F1813
80	0.50	14.00	Surface Mount	Screw Machine	Q47D	13X13 PGA Grid	AB-080-QF47DZ-P3-M-1	F4190
80	0.50	14.00	Surface Mount	Wire Wrap	Q47D	13X13 PGA Grid	AB-080-QF47DZ-P3-W-1	F5941
80	0.50	14.00 - 15.90	Surface Mount	Wire Wrap	Q47S	11X11 PGA Grid	AB-080-QF47S-P1-W	F1814
80	0.65	16.00 - 17.90	Surface Mount	Screw Machine	Q14	11X11 PGA Grid	AB-080-QF14S-P1-M	F2782
80	0.65	16.00 - 17.90	Surface Mount	Wire Wrap	Q14	11X11 PGA Grid	AB-080-QF14S-P1-W	F2783
80	0.65	17.20	Surface Mount	Screw Machine	Q14B	C	AB-080-QF14BZ-C-M-1	F1330
80	0.65	17.20	Surface Mount	Wire Wrap	Q14B	C	AB-080-QF14BZ-C-W-1	F2785
80	0.65	17.20	Surface Mount	Screw Machine	Q14B	13X13 PGA Grid	AB-080-QF14BZ-P3-M-1	F5555
80	0.65	17.20	Surface Mount	Wire Wrap	Q14B	13X13 PGA Grid	AB-080-QF14BZ-P3-W-1	F6094
80	0.65	16.00	Surface Mount	Screw Machine	Q14D	12X12 PGA Grid	AB-080-QF14DZ-P7-M-1	F4282
80	0.65	16.00	Surface Mount	Wire Wrap	Q14D	12X12 PGA Grid	AB-080-QF14DZ-P7-W-1	F5627
80	0.80	22.00/16.00 - 23.90/17.90	Surface Mount	Screw Machine	Q8	A	AB-080-QF08S-A-M	F2773
80	0.80	22.00/16.00 - 23.90/17.90	Surface Mount	Wire Wrap	Q8	A	AB-080-QF08S-A-W	F2774
80	0.80	22.00/16.00 - 23.90/17.90	Surface Mount	Screw Machine	Q8	B	AB-080-QF08S-B-M	F2775
80	0.80	22.00/16.00 - 23.90/17.90	Surface Mount	Screw Machine	Q8	C	AB-080-QF08S-C-M	F2777
80	0.80	22.00/16.00 - 23.90/17.90	Surface Mount	Screw Machine	Q8	14X14 PGA Grid	AB-080-QF08S-P8-M	F2779
80	0.80	22.00/16.00 - 23.90/17.90	Surface Mount	Wire Wrap	Q8	14X14 PGA Grid	AB-080-QF08S-P8-W	F2780
80	0.80	23.90/17.90	Zero Insertion Socket	Screw Machine	8A	15X15 PGA Grid	AB-080-QF08AZ-P4-M-1	F1230
80	0.80	23.90/17.90	Zero Insertion Socket	Wire Wrap	8A	15X15 PGA Grid	AB-080-QF08AZ-P4-W-1	F1231
100	0.50	16.00 - 17.90	Surface Mount	Screw Machine	Q49	13X13 PGA Grid	AB-100-QF49S-P3-M	F1815
100	0.50	16.00 - 17.90	Surface Mount	Wire Wrap	Q49	13X13 PGA Grid	AB-100-QF49S-P3-W	F1816
100	0.50	16.00	Zero Insertion Socket	Screw Machine	49D	17X17 PGA Grid	AB-100-QF49DZ-P10-M-1	F4295
100	0.50	16.00	Zero Insertion Socket	Wire Wrap	49D	17X17 PGA Grid	AB-100-QF49DZ-P10-W-1	F6919
100	0.50	16.00	Zero Insertion Socket	Screw Machine	49D	13X13 PGA Grid	AB-100-QF49DZ-P3-M-1	F2271
100	0.50	16.00	Zero Insertion Socket	Wire Wrap	49D	13X13 PGA Grid	AB-100-QF49DZ-P3-W-1	F2878
100	0.65	22.00/16.00 - 23.90/17.90	Surface Mount	Screw Machine	Q6	A	AB-100-QF06S-A-M	F2855
100	0.65	22.00/16.00 - 23.90/17.90	Surface Mount	Wire Wrap	Q6	A	AB-100-QF06S-A-W	F2856
100	0.65	22.00/16.00 - 23.90/17.90	Surface Mount	Screw Machine	Q6	B	AB-100-QF06S-B-M	F2857
100	0.65	22.00/16.00 - 23.90/17.90	Surface Mount	Wire Wrap	Q6	B	AB-100-QF06S-B-W	F2858
100	0.65	22.00/16.00 - 23.90/17.90	Surface Mount	Screw Machine	Q6	C	AB-100-QF06S-C-M	F2859
100	0.65	22.00/16.00 - 23.90/17.90	Surface Mount	Wire Wrap	Q6	C	AB-100-QF06S-C-W	F2860
100	0.65	22.00/16.00 - 23.90/17.90	Surface Mount	Screw Machine	Q6	14X14 PGA Grid	AB-100-QF06S-P8-M	F2861
100	0.65	22.00/16.00 - 23.90/17.90	Surface Mount	Wire Wrap	Q6	14X14 PGA Grid	AB-100-QF06S-P8-W	F2862
100	0.65	23.20/17.20 - 23.90/17.90	Zero Insertion Socket	Screw Machine	Q6A/B	A & B	AB-100-QF06A/BZ-A-M-1	F2863
100	0.65	23.20/17.20 - 23.90/17.90	Zero Insertion Socket	Screw Machine	Q6A/B	A & B	AB-100-QF06A/BZ-A-W-1	F2865
100	0.65	23.20/17.20 - 23.90/17.90	Zero Insertion Socket	Screw Machine	Q6A/B	A & B	AB-100-QF06A/BZ-C-M-1	F2868
100	0.65	23.20/17.20 - 23.90/17.90	Zero Insertion Socket	Wire Wrap	Q6A/B	A & B	AB-100-QF06A/BZ-C-W-1	F2870
100	0.65	23.20/17.20 - 23.90/17.90	Zero Insertion Socket	Screw Machine	Q6A/B	14X14 PGA Grid	AB-100-QF06A/BZ-P8-M-1	F1789
100	0.65	23.20/17.20 - 23.90/17.90	Zero Insertion Socket	Wire Wrap	Q6A/B	14X14 PGA Grid	AB-100-QF06A/BZ-P8-W-1	F2873
100	0.65	22.00/16.00	Zero Insertion Socket	Screw Machine	Q6D	14X14 PGA Grid	AB-100-QF06DZ-P8-M-1	F4423
100	0.65	22.00/16.00	Zero Insertion Socket	Wire Wrap	Q6D	14X14 PGA Grid	AB-100-QF06DZ-P8-W-1	F6159
100	.025"	.880"	Surface Mount	Screw Machine	Q1	15X15 PGA Grid	AB-100-QF01S-P4-M	F1240
112	0.65	23.20	Zero Insertion Socket	Wire Wrap	Q36B	15X15 PGA Grid	AB-112-QF36BZ-P4-W-1	F2052

PROTOTYPING ADAPTERS, EXTENDERS & PROTOTYPING BOARDS

PROTOTYPING ADAPTERS - FULLY ASSEMBLED & TESTED

Prototyping PC Board Configurations

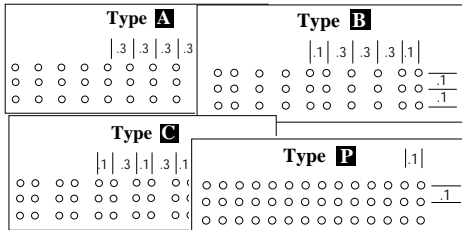

- P5= PGA 8X8 P10= PGA 17X17 P19= PGA 26X26
- P6= PGA 9X9 P11= PGA 18X18 P20= PGA 27x27
- P2= PGA 10X10 P12= PGA 19X19 P21= PGA 28X28
- P1= PGA 11X11 P13= PGA 20X20 P22= PGA 29x29
- P7= PGA 12X12 P14= PGA 21X21 P23= PGA 30X30
- P3= PGA 13X13 P15= PGA 22X22 P24= PGA 31X31
- P8= PGA 14X14 P16= PGA 23X23 P25= PGA 32X32
- P4= PGA 15X15 P17= PGA 24X24 P26= PGA 33x33
- P9= PGA 16X16 P18= PGA 25X25 P27= PGA 34x34

Ordering Information Example

Pin Count _____ Prototyping PC Board Configurations (see below)

Product Code _____ AB-120-QF05 (Z)-P10-M-(1)

Chip Pkg Socket Footprint _____

Top Socket Configurations _____

CQFP & PQFP only:

S = SMT Pads
P = Production
Z = ZIF Socket

Optional:
1 = Socket Included
0 = Socket Not Included

Bottom Male Pin Type:
M = Screw Machine Pin
W = Wire Wrap Post

For a complete list of prototyping adapter specifications, pricing and delivery information, please see

Web Link: www.1800adapter.com/004

PQFP/TQFP (cont.)

Pin Count	Lead Pitch (mm)	Tip-to-Tip mm (sq.)	Adapter Top Female Configuration	Bottom Pin Type	Bottom Configuration Type	Adapter Bottom Male Configuration	ET Part #	Drawing #
112	0.65	22.00	Zero Insertion Socket	Screw Machine	Q36D	15X15 PGA Grid	AB-112-QF36DZ-P4-M-0	F6361
112	0.65	22.00	Zero Insertion Socket	Screw Machine	Q36D	15X15 PGA Grid	AB-112-QF36DZ-P4-M-1	F6362
120	0.80	30.00 - 31.90	Surface Mount	Screw Machine	Q5	15X15 PGA Grid	AB-120-QF05S-P4-M	F2891
120	0.80	30.00 - 31.90	Surface Mount	Wire Wrap	Q5	15X15 PGA Grid	AB-120-QF05S-P4-W	F2892
120	0.80	16.00 - 17.90	Surface Mount	Screw Machine	Q56	12X12 PGA Grid	AB-120-QF56S-P7-M	F6026
120	0.80	16.00 - 17.90	Surface Mount	Wire Wrap	Q56	12X12 PGA Grid	AB-120-QF56S-P7-W	F6096
120	0.80	17.90	Zero Insertion Socket	Screw Machine	Q5A	17X17 PGA Grid	AB-120-QF05AZ-P10-M-1	F1696
120	0.80	17.90	Zero Insertion Socket	Wire Wrap	Q5A	17X17 PGA Grid	AB-120-QF05AZ-P10-W-1	F2895
128	0.40	16.00	Zero Insertion Socket	Screw Machine	Q57	24X24 PGA Grid	AB-128-QF57DZ-P17-M-0	F6849
128	0.50	22.00/16.00 - 23.90/17.90	Surface Mount	Screw Machine	Q51	13X13 PGA Grid	AB-128-QF51S-P3-M	F4427
128	0.50	22.00/16.00 - 23.90/17.90	Surface Mount	Wire Wrap	Q51	13X13 PGA Grid	AB-128-QF51S-P3-W	F5066
128	0.50	23.20/17.20 - 23.90/17.90	Zero Insertion Socket	Screw Machine	Q51A/B	18X18 PGA Grid	AB-128-QF51A/BZ-P11-M-1	F2916
128	0.50	23.20/17.20 - 23.90/17.90	Zero Insertion Socket	Wire Wrap	Q51A/B	18X18 PGA Grid	AB-128-QF51A/BZ-P11-W-1	F4428
128	0.50	23.20/17.20	Zero Insertion Socket	Screw Machine	Q51B	18X18 PGA Grid	AB-128-QF51BZ-P18-M-1	F5543
128	0.50	22.00/16.00	Zero Insertion Socket	Screw Machine	Q51D	18X18 PGA Grid	AB-128-QF51DZ-P18-M-1	F5930
128	0.50	22.00/16.00	Zero Insertion Socket	Wire Wrap	Q51D	18X18 PGA Grid	AB-128-QF51DZ-P18-W-1	F4078
128	0.50	16.00	Zero Insertion Socket	Screw Machine	Q57D	24X24 PGA Grid	AB-128-QF57DZ-P17-M-1	F6620
128	0.50	16.00	Zero Insertion Socket	Wire Wrap	Q57D	24X24 PGA Grid	AB-128-QF57DZ-P17-W-1	F6619
128	0.80	31.46 - 31.90	Surface Mount	Screw Machine	Q13	A	AB-128-QF13S-A-M	F2902
128	0.80	31.46 - 31.90	Surface Mount	Wire Wrap	Q13	A	AB-128-QF13S-A-W	F2903
128	0.80	31.46 - 31.90	Surface Mount	Screw Machine	Q13	15X15 PGA Grid	AB-128-QF13S-P4-M	F2906
128	0.80	31.46 - 31.90	Surface Mount	Wire Wrap	Q13	15X15 PGA Grid	AB-128-QF13S-P4-W	F2907
128	0.80	31.90	Zero Insertion Socket	Screw Machine	Q13A	17X17 PGA Grid	AB-128-QF13AZ-P10-M-1	F2909
128	0.80	31.90	Zero Insertion Socket	Wire Wrap	Q13A	17X17 PGA Grid	AB-128-QF13AZ-P10-W-1	F2911
128	0.80	31.90	Zero Insertion Socket	Screw Machine	Q13A	19X19 PGA Grid	AB-128-QF13AZ-P12-M-1	F2913
128	0.80	31.90	Zero Insertion Socket	Wire Wrap	Q13A	19X19 PGA Grid	AB-128-QF13AZ-P12-W-1	F2915
128	0.80	31.20	Zero Insertion Socket	Wire Wrap	Q13B	17X17 PGA Grid	AB-128-QF13BZ-P10-W-1	F4426
132	.025"	1.080"	Surface Mount	Screw Machine	Q3	17X17 PGA Grid	AB-132-QF03S-P10-M	F1121
132	.025"	1.080"	Surface Mount	Wire Wrap	Q3	17X17 PGA Grid	AB-132-QF03S-P10-W	F2923
132	.025"	1.080"	Zero Insertion Socket	Screw Machine	Q3	18X18 PGA Grid	AB-132-QF03Z-P11-M-1	F1317
132	.025"	1.080"	Zero Insertion Socket	Wire Wrap	Q3	18X18 PGA Grid	AB-132-QF03Z-P11-W-1	F1318
132	.025"	1.080"	Production Socket	Screw Machine	Q3A	A	AB-132-QF03A-A-M	F2921
132	.025"	1.080"	Production Socket	Wire Wrap	Q3A	A	AB-132-QF03A-A-W	F2922
132	.025"	1.080"	Production Socket	Screw Machine	Q3A	C	AB-132-QF03A-C-M	F3797
132	.025"	1.080"	Production Socket	Wire Wrap	Q3A	C	AB-132-QF03A-C-W	F3798
144	0.50	22.00 - 23.90	Surface Mount	Screw Machine	Q63	19X19 PGA Grid	AB-144-QF63S-P12H-M	F1945
144	0.50	22.00 - 23.90	Surface Mount	Wire Wrap	Q63	19X19 PGA Grid	AB-144-QF63S-P12H-W	F1946
144	0.50	22.00 - 23.90	Surface Mount	Screw Machine	Q63	16X16 PGA Grid	AB-144-QF63S-P9-M	F2170
144	0.50	22.00 - 23.90	Surface Mount	Wire Wrap	Q63	16X16 PGA Grid	AB-144-QF63S-P9-W	F2187
144	0.50	22.00	Zero Insertion Socket	Screw Machine	Q63D	17X17 PGA Grid	AB-144-QF63DZ-P10-M-1	F2096
144	0.50	22.00	Zero Insertion Socket	Screw Machine	Q63D	17X17 PGA Grid	AB-144-QF63DZ-P10-M-1	F4430
144	0.50	22.00	Zero Insertion Socket	Wire Wrap	Q63D	17X17 PGA Grid	AB-144-QF63DZ-P10-W-1	F2958
144	0.65	30.00 - 31.90	Surface Mount	Screw Machine	Q10	17X17 PGA Grid	AB-144-QF10S-P10-M	F2946
144	0.65	30.00 - 31.90	Surface Mount	Wire Wrap	Q10	17X17 PGA Grid	AB-144-QF10S-P10-W	F2947
144	0.65	31.20	Zero Insertion Socket	Screw Machine	Q10B	A	AB-144-QF10BZ-A-M-1	F2949
144	0.65	31.20	Zero Insertion Socket	Wire Wrap	Q10B	A	AB-144-QF10BZ-A-W-1	F2951
144	0.65	31.20	Zero Insertion Socket	Screw Machine	Q10B	19X19 PGA Grid	AB-144-QF10BZ-P12-M-1	F1796

FULLY ASSEMBLED & TESTED - PROTOTYPING ADAPTERS

Ordering Information Example

Pin Count _____
 Product Code _____ AB-120-QF05 (Z)-P10-M-(1)
 Chip Pkg Socket Footprint _____
 Top Socket Configurations _____
 CQFP & PQFP only:

S = SMT Pads
 P = Production
 Z = ZIF Socket

Prototyping PC Board Configurations (see below)
 Optional:
 1 = Socket Included
 0 = Socket Not Included

Bottom Male Pin Type:
 M = Screw Machine Pin
 W = Wire Wrap Post

For a complete list of prototyping adapter specifications, pricing and delivery information, please see

Web Link: www.1800adapter.com/004

Prototyping PC Board Configurations

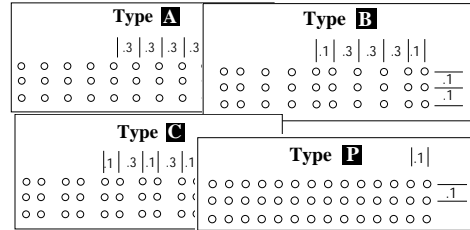

- P5= PGA 8X8 P10= PGA 17X17 P19= PGA 26X28
- P6= PGA 9X9 P11= PGA 18X18 P20= PGA 27x27
- P2= PGA 10X10 P12= PGA 19X19 P21= PGA 28X28
- P1= PGA 11X11 P13= PGA 20X20 P22= PGA 29x29
- P7= PGA 12X12 P14= PGA 21X21 P23= PGA 30X30
- P3= PGA 13X13 P15= PGA 22X22 P24= PGA 31X31
- P8= PGA 14X14 P16= PGA 23X23 P25= PGA 32X32
- P4= PGA 15X15 P17= PGA 24X24 P26= PGA 33x33
- P9= PGA 16X16 P18= PGA 25X25 P27= PGA 34x34

PQFP/TQFP (cont.)

Pin Count	Lead Pitch (mm)	Tip-to-Tip mm (sq.)	Adapter Top Female Configuration	Bottom Pin Type	Bottom Configuration Type	Adapter Bottom Male Configuration	ET Part #	Drawing #
144	0.65	31.20	Zero Insertion Socket	Wire Wrap	Q10B	19X19 PGA Grid	AB-144-QF10BZ-P12-W-1	F2956
144	0.65	31.20	Zero Insertion Socket	Wire Wrap	Q10B	19X19 PGA Grid	AB-144-QF10BZ-P12-W-1	F4429
160	0.50	26.00 - 27.90	Surface Mount	Screw Machine	Q48	C	AB-160-QF48S-C-M	F4431
160	0.50	26.00 - 27.90	Surface Mount	Wire Wrap	Q48	C	AB-160-QF48S-C-W	F4432
160	0.50	26.00 - 27.90	Surface Mount	Screw Machine	Q48	19X19 PGA Grid	AB-160-QF48S-P12-M	F1718
160	0.50	26.00 - 27.90	Surface Mount	Wire Wrap	Q48	19X19 PGA Grid	AB-160-QF48S-P12-W	F1717
160	0.65	30.00 - 31.90	Surface Mount	Screw Machine	Q7	A	AB-160-QF07S-A-M	F2966
160	0.65	30.00 - 31.90	Surface Mount	Wire Wrap	Q7	A	AB-160-QF07S-A-W	F2967
160	0.65	30.00 - 31.90	Surface Mount	Screw Machine	Q7	C	AB-160-QF07S-C-M	F2968
160	0.65	30.00 - 31.90	Surface Mount	Wire Wrap	Q7	C	AB-160-QF07S-C-W	F2969
160	0.65	30.00 - 31.90	Surface Mount	Screw Machine	Q7	17X17 PGA Grid	AB-160-QF07S-P10-M	F2970
160	0.65	30.00 - 31.90	Surface Mount	Wire Wrap	Q7	17X17 PGA Grid	AB-160-QF07S-P10-W	F2971
160	0.65	30.00 - 31.90	Surface Mount	Screw Machine	Q7	19X19 PGA Grid	AB-160-QF07S-P12-M	F1918
160	0.65	30.00 - 31.90	Surface Mount	Wire Wrap	Q7	19X19 PGA Grid	AB-160-QF07S-P12-W	F1919
160	0.65	31.90	Zero Insertion Socket	Screw Machine	Q7A	19X19 PGA Grid	AB-160-QF07AZ-P12-M-1	F1074
160	0.65	31.90	Zero Insertion Socket	Wire Wrap	Q7A	19X19 PGA Grid	AB-160-QF07AZ-P12-W-1	F2976
160	0.65	31.20	Zero Insertion Socket	Wire Wrap	Q7B	19X19 PGA Grid	AB-160-QF07BZ-P12-W-1	F6222
160	0.65	30.00 - 31.90	Production Socket	Wire Wrap	Q7	A	AB-160-QF07P-A-W-1	F6855
172	.025"	1.150" sq	Zero Insertion Socket	Screw Machine	Q12	23X23 PGA Grid	AB-172-QF12Z-P16-M-1	F1075
172	.025"	1.150" sq	Zero Insertion Socket	Wire Wrap	Q12	23X23 PGA Grid	AB-172-QF12Z-P16-W-1	F2999
176	0.40	22.00 - 23.90	Surface Mount	Screw Machine	Q19	16X16 PGA Grid	AB-176-QF19S-P9-M	F60F0
176	0.40	22.00	Zero Insertion Socket	Screw Machine	Q19D	16X16 PGA Grid	AB-176-QF19DZ-P14-M-1	F3007
176	0.40	22.00	Zero Insertion Socket	Wire Wrap	Q19D	16X16 PGA Grid	AB-176-QF19DZ-P14-W-1	F3009
176	0.50	26.00 - 27.90	Surface Mount	Screw Machine	Q67	17X17 PGA Grid	AB-176-QF67S-P10-M	F2031
176	0.50	26.00 - 27.90	Surface Mount	Wire Wrap	Q67	17X17 PGA Grid	AB-176-QF67S-P10-W	F2032
176	0.50	26.00	Zero Insertion Socket	Screw Machine	Q67D	A	AB-176-QF67DZ-A-M-1	F3010
176	0.50	26.00	Zero Insertion Socket	Wire Wrap	Q67D	A	AB-176-QF67DZ-A-W-1	F4753
176	0.50	26.00	Zero Insertion Socket	Screw Machine	Q67D	17X17 PGA Grid	AB-176-QF67DZ-P10-M-1	F2004
176	0.50	26.00	Zero Insertion Socket	Wire Wrap	Q67D	17X17 PGA Grid	AB-176-QF67DZ-P10-W-1	F2006
196	.025"	1.480"	Surface Mount	Screw Machine	Q15	20X20 PGA Grid	AB-196-QF15S-P13-M	F1391
196	.025"	1.480"	Surface Mount	Wire Wrap	Q15	20X20 PGA Grid	AB-196-QF15S-P13-W	F3015
196	.025"	1.480"	Zero Insertion Socket	Screw Machine	Q15	20X20 PGA Grid	AB-196-QF15Z-P13-M-1	F1350
196	.025"	1.480"	Zero Insertion Socket	Wire Wrap	Q15	20X20 PGA Grid	AB-196-QF15Z-P13-W-1	F3017
208	0.50	30.00 - 31.90	Surface Mount	Screw Machine	Q21	A	AB-208-QF21S-A-M	F3022
208	0.50	30.00 - 31.90	Surface Mount	Wire Wrap	Q21	A	AB-208-QF21S-A-W	F3023
208	0.50	30.00 - 31.90	Surface Mount	Screw Machine	Q21	C	AB-208-QF21S-C-M	F5661
208	0.50	30.00 - 31.90	Surface Mount	Wire Wrap	Q21	C	AB-208-QF21S-C-W	F3025
208	0.50	30.00 - 31.90	Surface Mount	Screw Machine	Q21	17X17 PGA Grid	AB-208-QF21S-P10-M	F2303
208	0.50	30.00 - 31.90	Surface Mount	Wire Wrap	Q21	17X17 PGA Grid	AB-208-QF21S-P10-W	F6446
208	0.50	30.00 - 31.90	Surface Mount	Screw Machine	Q21	18X18 PGA Grid	AB-208-QF21S-P11-M	F3026
208	0.50	30.00 - 31.90	Surface Mount	Wire Wrap	Q21	18X18 PGA Grid	AB-208-QF21S-P11-W	F3027
208	0.50	30.00 - 31.90	Surface Mount	Screw Machine	Q21	20X20 PGA Grid	AB-208-QF21S-P13-M	F2071
208	0.50	30.00 - 31.90	Surface Mount	Wire Wrap	Q21	20X20 PGA Grid	AB-208-QF21S-P13-W	F3028
208	0.50	30.00 - 31.90	Zero Insertion Socket	Screw Machine	Q21	20X20 PGA Grid	AB-208-QF21ZYAM-P13-M-1-B7	F6359
208	0.50	30.00 - 31.90	Zero Insertion Socket	Screw Machine	Q21B	21X21PGA Grid	AB-208-QF21BZENP-P14-M-1	F2125
208	0.50	30.00 - 31.90	Zero Insertion Socket	Wire Wrap	Q21B	21X21PGA Grid	AB-208-QF21BZENP-P14-W-1	F3030
208	0.50	30.00 - 31.90	Zero Insertion Socket	Screw Machine	Q21B	C	AB-208-QF21BZYAM-C-M-1	F3951
208	0.50	30.00 - 31.90	Zero Insertion Socket	Screw Machine	Q21B	20X20 PGA Grid	AB-208-QF21BZYAM-P13-M-1	F1451
208	0.50	30.00 - 31.90	Zero Insertion Socket	Wire Wrap	Q21B	20X20 PGA Grid	AB-208-QF21BZYAM-P13-W-1	F3032

PROTOTYPING ADAPTERS, EXTENDERS & PROTOTYPING BOARDS

PROTOTYPING ADAPTERS - FULLY ASSEMBLED & TESTED

Prototyping PC Board Configurations

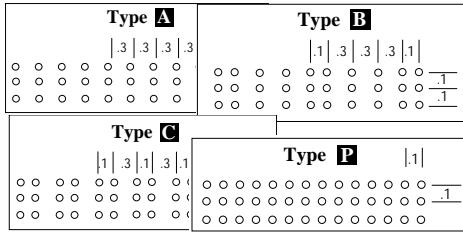

P5= PGA 8X8	P10= PGA 17X17	P19= PGA 26X26
P6= PGA 9X9	P11= PGA 18X18	P20= PGA 27x27
P2= PGA 10X10	P12= PGA 19X19	P21= PGA 28X28
P1= PGA 11X11	P13= PGA 20X20	P22= PGA 29x29
P7= PGA 12X12	P14= PGA 21X21	P23= PGA 30X30
P3= PGA 13X13	P15= PGA 22X22	P24= PGA 31X31
P8= PGA 14X14	P16= PGA 23X23	P25= PGA 32X32
P4= PGA 15X15	P17= PGA 24X24	P26= PGA 33x33
P9= PGA 16X16	P18= PGA 25X25	P27= PGA 34x34

Ordering Information Example

Pin Count ————— Prototyping PC Board Configurations (see below)

Product Code ————— AB-120-QF05 (Z)-P10-M-(1)

Chip Pkg Socket Footprint —————

Top Socket Configurations —————

CQFP & PQFP only:

S = SMT Pads
P = Production
Z = ZIF Socket

Optional:
1 = Socket Included
0 = Socket Not Included

Bottom Male Pin Type:
M = Screw Machine Pin
W = Wire Wrap Post

For a complete list of prototyping adapter specifications, pricing and delivery information, please see

Web Link: www.1800adapter.com/004

PQFP/TQFP (cont.)

Pin Count	Lead Pitch (mm)	Tip-to-Tip (mm (sq.))	Adapter Top Female Configuration	Bottom Pin Type	Bottom Configuration Type	Adapter Bottom Male Configuration	ET Part #	Drawing#
208	0.50	30.00 - 31.90	Zero Insertion Socket	Screw Machine	Q21C	20X20 PGA Grid	AB-208-QF21CZ-P13-M-1	F4436
208	0.50	30.00 - 31.90	Zero Insertion Socket	Screw Machine	Q21C	21X21PGA Grid	AB-208-QF21CZ-P14-M-1	F1473
208	0.50	30.00 - 31.90	Zero Insertion Socket	Wire Wrap	Q21C	21X21PGA Grid	AB-208-QF21CZ-P14-W-1	F6090
216	0.40	26.00	Surface Mount	Screw Machine	Q65	16X16 PGA Grid	AB-216-QF65S-P9-M	F6034
240	0.50	34.00 - 35.90	Surface Mount	Screw Machine	Q62	20X20 PGA Grid	AB-240-QF62S-P13-M	F1515
240	0.50	34.00 - 35.90	Surface Mount	Wire Wrap	Q62	20X20 PGA Grid	AB-240-QF62S-P13-W	F4438
240	0.50	34.60	Zero Insertion Socket	Screw Machine	Q62C	C	AB-240-QF62CZ-C-M-1	F3042
240	0.50	34.60	Zero Insertion Socket	Wire Wrap	Q62C	C	AB-240-QF62CZ-C-W-1	F4767
240	0.50	34.60	Zero Insertion Socket	Screw Machine	Q62C	18X18 PGA Grid	AB-240-QF62CZ-P11-M-1	F5837
240	0.50	34.60	Zero Insertion Socket	Screw Machine	Q62C	20X20 PGA Grid	AB-240-QF62CZ-P13-M-1	F1659
240	0.50	34.60	Zero Insertion Socket	Wire Wrap	Q62C	20X20 PGA Grid	AB-240-QF62CZ-P13-W-1	F2298
304	0.50	42.60	Zero Insertion Socket	Screw Machine	Q61C	21X21PGA Grid	AB-304-QF61CZ-P14-M-1	F3931
304	0.50	42.60	Zero Insertion Socket	Screw Machine	Q61C	27x27 PGA GRID	AB-304-QF61CZ-P20-M-1	F3994

DIP

Pin Count	Package Specs (width/inches)	Adapter Top Female Config.	Adapter Bottom Male Config. (inches)	Bottom Pin Type	Description	Drawing#
20	.300 DIP	Production Socket	.600 DIP	Screw Machine	AB-020-300FEM-600MALE-M	F5536
20	.600 DIP	Production Socket	.300 DIP	Screw Machine	AB-020-600FEM-300MALE-M	F2603
20	.600 DIP	Production Socket	.300 DIP	Wire Wrap	AB-020-600FEM-300MALE-W	F2604
20	.600 DIP	Production Socket	.400 DIP	Screw Machine	AB-020-600FEM-400MALE-M	F4186
20	.600 DIP	Production Socket	.400 DIP	Wire Wrap	AB-020-600FEM-400MALE-W	F4435
24	.300 DIP	Production Socket	.600 DIP	Screw Machine	AB-024-300FEM-600MALE-M	F2619
24	.600 DIP	Production Socket	.300 DIP	Screw Machine	AB-024-600FEM-300MALE-M	F2625
24	.600 DIP	Production Socket	.300 DIP	Wire Wrap	AB-024-600FEM-300MALE-W	F2626
28	.300 DIP	Production Socket	.600 DIP	Screw Machine	AB-028-300FEM-600MALE-M	F2634
28	.300 DIP	Production Socket	.600 DIP	Wire Wrap	AB-028-300FEM-600MALE-W	F2635
28	.300 DIP	Production Socket	.600 DIP	Screw Machine	AB-028-400FEM-600MALE-M	F2636
28	.300 DIP	Production Socket	.600 DIP	Wire Wrap	AB-028-400FEM-600MALE-W	F2637
28	.600 DIP	Production Socket	.300 DIP	Screw Machine	AB-028-600FEM-300MALE-M	F2638
28	.600 DIP	Production Socket	.300 DIP	Wire Wrap	AB-028-600FEM-300MALE-W	F2639
28	.600 DIP	Production Socket	.400 DIP	Screw Machine	AB-028-600FEM-400MALE-M	F2640
28	.600 DIP	Production Socket	.400 DIP	Wire Wrap	AB-028-600FEM-400MALE-W	F2641
32	.400 DIP	Production Socket	.600 DIP	Screw Machine	AB-032-400FEM-600MALE-M	F1062
32	.600 DIP	Production Socket	.300 DIP	Screw Machine	AB-032-600FEM-300MALE-M	F2659
40	.600 DIP	Production Socket	.300 DIP	Screw Machine	AB-040-600FEM-300MALE-M	F2669
40	.600 DIP	Production Socket	.300 DIP	Wire Wrap	AB-040-600FEM-300MALE-W	F2670

SDIP

Pin Count	Package Specs (width/inches)	Adapter Top Female Config.	Adapter Bottom Male Config.	Bottom Pin Type	Description	Drawing#
28	.750 SDIP	Production Socket	Type B & C	Screw Machine	AB-028/030-SDIP-B/C-M,	F2656
28	.750 SDIP	Production Socket	Type B & C	Wire Wrap	AB-028/030-SDIP-B/C-W,	F2657
40	.750 SDIP	Production Socket	Type B & C	Screw Machine	AB-040/042-SDIP-B/C-M,	F2672
40	.750 SDIP	Production Socket	Type B & C	Wire Wrap	AB-040/042-SDIP-B/C-W,	F2673
48	.750 SDIP	Production Socket	Type A & B	Screw Machine	AB-048/052-SDIP-A/B-M,	F2702
56	.650 SDIP	Production Socket	Type C	Screw Machine	AB-056-SDIP-C-M	F6624
56	.650 SDIP	Production Socket	Type C	Wire Wrap	AB-056-SDIP-C-W	F6623
64	.750 SDIP	Production Socket	Type A & B	Screw Machine	AB-064-SDIP-A/B-M,	F2749
64	.750 SDIP	Production Socket	Type A & B	Wire Wrap	AB-064-SDIP-A/B-W,	F2750

FULLY ASSEMBLED & TESTED -PROTOTYPING ADAPTERS

Prototyping PC Board Configurations

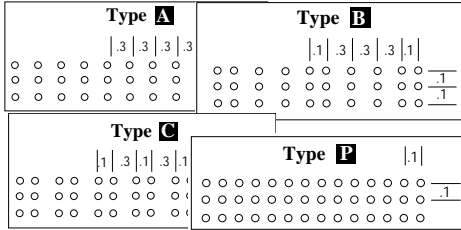

- P5= PGA 8X8 P10= PGA 17X17 P19= PGA 26X26
- P6= PGA 9X9 P11= PGA 18X18 P20= PGA 27x27
- P2= PGA 10X10 P12= PGA 19X19 P21= PGA 28X28
- P1= PGA 11X11 P13= PGA 20X20 P22= PGA 29x29
- P7= PGA 12X12 P14= PGA 21X21 P23= PGA 30X30
- P3= PGA 13X13 P15= PGA 22X22 P24= PGA 31X31
- P8= PGA 14X14 P16= PGA 23X23 P25= PGA 32X32
- P4= PGA 15X15 P17= PGA 24X24 P26= PGA 33x33
- P9= PGA 16X16 P18= PGA 25X25 P27= PGA 34x34

Ordering Information Example

Pin Count _____ Prototyping PC Board Configurations (see below)
 Product Code _____ AB-120-QF05 (Z)-P10-M-(1)
 Chip Pkg Socket Footprint _____
 Top Socket Configurations _____
 CQFP & PQFP only: S = SMT Pads
 P = Production
 Z = ZIF Socket

Optional:
 1 = Socket Included
 0 = Socket Not Included

Bottom Male Pin Type:
 M = Screw Machine Pin
 W = Wire Wrap Post

For a complete list of prototyping adapter specifications, pricing and delivery information, please see

Web Link: www.1800adapter.com/004

SOIC/SSOP

Pin Count	Lead Pitch (mm)	Tip-to-Tip mm (sq.)	Adapter Top Female Configuration	Adapter Bottom Male Configuration	Bottom Pin Type	ET Part #	Drawing #
8	1.27	3.90	Surface Mount	.300" DIP	Screw Machine	AB-008-SO01S-A-M	F6748
8	0.65	3.00	Zero Insertion Socket	.300" DIP	Screw Machine	AB-008-ST36Z-A-M-1	F6515
20	0.65	4.4 to 8.00	Surface Mount	.300" DIP	Screw Machine	AB-020-ST03S-A-M	F6045
20	0.65	4.4 to 8.00	Surface Mount	.300" DIP	Wire Wrap	AB-020-ST03S-A-W	F6044
20	0.50	3.00 to 9.90	Surface Mount	.300" DIP	Screw Machine	AB-020-ST35S-A-M	F6038
20	0.50	3.00 to 9.90	Surface Mount	.300" DIP	Wire Wrap	AB-020-ST35S-A-W	F5157
24	0.65	4.40	Surface Mount	.300" DIP	Screw Machine	AB-024-SO03S-A-M	F6607
24	1.00	9.90	Surface Mount	C	Screw Machine	AB-024-SS08S-C-M	F2629
28	1.27	3.90	Surface Mount	A	Screw Machine	AB-028-SO01S-A-M	F6091
28	1.27	3.90	Surface Mount	A	Wire Wrap	AB-028-SO01S-A-W	F6092
28	0.635	3.80 to 7.62	Surface Mount	A	Screw Machine	AB-028-SS01S-A-M	F6035
28	0.635	3.80 to 7.62	Surface Mount	A	Wire Wrap	AB-028-SS01S-A-W	F3035
28	0.635	7.62	Zero Insertion Socket	P7	Screw Machine	AB-028-SS06Z-P7-M-1	F1088
28	0.635	7.62	Zero Insertion Socket	P7	Wire Wrap	AB-028-SS06Z-P7-W-1	F5080
28	0.65	5.30	Surface Mount	.300" DIP	Screw Machine	AB-028-SS34S-300-M	F6165
28	0.65	5.30	Surface Mount	.300" DIP	Wire Wrap	AB-028-SS34S-300-W	F6164
28	0.65	5.30	Surface Mount	.600" DIP	Screw Machine	AB-028-SS34S-600-M	F6160
28	0.65	5.30	Surface Mount	.600" DIP	Wire Wrap	AB-028-SS34S-600-W	F6131
36	0.80	7.62	Zero Insertion Socket	A	Screw Machine	AB-036-SS16Z-A-M-1	F6508
44	1.27	13.20	Surface Mount	A	Screw Machine	AB-044-SO09PS-A-M	F6009
44	1.27	13.20	Surface Mount	A	Wire Wrap	AB-044-SO09PS-A-W	F6013
44	1.27	13.20	Surface Mount	A	Screw Machine	AB-044-SO09S-A-M	F2602
44	1.27	13.20	Surface Mount	A	Wire Wrap	AB-044-SO09S-A-W	F5148
44	1.27	13.20	Surface Mount	C	Screw Machine	AB-044-SO09S-C-M	F4291
44	1.27	13.20	Surface Mount	C	Wire Wrap	AB-044-SO09S-C-W	F6093
48	0.635	7.62	Zero Insertion Socket	P1	Screw Machine	AB-048-SS06Z-P1-M-1	F5829
48	0.635	7.62	Zero Insertion Socket	P1	Wire Wrap	AB-048-SS06Z-P1-W-1	F5830
48	0.50	6.10 to 8.00	Surface Mount	A	Screw Machine	AB-048-SS15S-A-M	F5309
48	0.50	6.10 to 8.00	Surface Mount	A	Wire Wrap	AB-048-SS15S-A-W	F4421
48	0.50	6.10 to 8.00	Zero Insertion Socket	C	Screw Machine	AB-048-SS15Z-C-M-1	F5009
56	0.635	7.62	Zero Insertion Socket	P1	Screw Machine	AB-056-SS06Z-P1-M-1	F2217
56	0.635	7.62	Zero Insertion Socket	P1	Wire Wrap	AB-056-SS06Z-P1-W-1	F3723
56	0.50	6.10	Surface Mount	A	Screw Machine	AB-056-SS15S-A-M	F5062
56	0.50	6.10	Surface Mount	A	Wire Wrap	AB-056-SS15S-A-W	F6097

PROTOTYPING ADAPTERS, EXTENDERS & PROTOTYPING BOARDS

Try our Quick Probe Test Fixture

Designed to quickly connect a test instrument, such as an oscilloscope, to a variety of SMDs including PLCC, SOIC, QFP, and VIAS or test point holes.

Web Link: www.1800adapter.com/quickprobe

For a complete list of product specifications, pricing and delivery information, please see:

Web Link: www.1800adapter.com/004

PROTOTYPING ADAPTERS - FULLY ASSEMBLED & TESTED

Ordering Information Example

Pin Count _____ Prototyping PC Board Configurations (see below)
 Product Code _____ AB-120-QF05 (Z)-P10-M-(1)
 Chip Pkg Socket Footprint _____
 Top Socket Configurations _____
 CQFP & PQFP only: S = SMT Pads
 P = Production
 Z = ZIF Socket

Optional:
 1 = Socket Included
 0 = Socket Not Included

Bottom Male Pin Type:
 M = Screw Machine Pin
 W = Wire Wrap Post

For a complete list of product specifications, pricing and delivery information, please see

Web Link: www.1800adapter.com/004

Prototyping PC Board Configurations

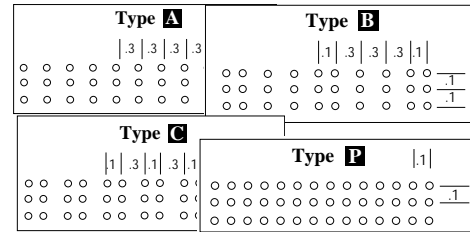

- P5= PGA 8X8 P10= PGA 17X17 P19= PGA 26X26
- P6= PGA 9X9 P11= PGA 18X18 P20= PGA 27x27
- P2= PGA 10X10 P12= PGA 19X19 P21= PGA 28X28
- P1= PGA 11X11 P13= PGA 20X20 P22= PGA 29x29
- P7= PGA 12X12 P14= PGA 21X21 P23= PGA 30X30
- P3= PGA 13X13 P15= PGA 22X22 P24= PGA 31X31
- P8= PGA 14X14 P16= PGA 23X23 P25= PGA 32X32
- P4= PGA 15X15 P17= PGA 24X24 P26= PGA 33x33
- P9= PGA 16X16 P18= PGA 25X25 P27= PGA 34x34

TSOP, TSOP II

Pin Count	Lead Pitch (mm)	Package Specs Width (inches)	Adapter Top Female Configuration	Adapter Bottom Male Configuration	Bottom Pin Type	ET Part #	Drawing #
32	0.50	18.40	Surface Mount	P2	Screw Machine	AB-032-TS01S-P2-M	F4405
32	0.50	18.40	Surface Mount	P2	Wire Wrap	AB-032-TS01S-P2-W	F5710
40	0.50	18.40	Production Socket	A	Screw Machine	AB-040-TS01PS-A-M	F6010
40	0.50	18.40	Production Socket	A	Wire Wrap	AB-040-TS01PS-A-W	F6014
44	0.50	18.40	Surface Mount	P2	Screw Machine	AB-044-TS01S-P2-M	F4406
48	0.50	18.40	Production Socket	.600" DIP	Screw Machine	AB-048-TS01PS-A-M	F6011
48	0.50	18.40	Production Socket	.600" DIP	Wire Wrap	AB-048-TS01PS-A-W	F6015
48	0.50	18.40	Surface Mount	P2	Screw Machine	AB-048-TS01S-P2-M	F4407
48	0.50	18.40	Surface Mount	P2	Wire Wrap	AB-048-TS01S-P2-W	F5831
48	0.50	18.40	Zero Insertion Socket	P5	Screw Machine	AB-048-TS01Z-P5-M-1	F4492
48	0.50	18.40	Zero Insertion Socket	P5	Wire Wrap	AB-048-TS01Z-P5-W-1	F5833
50	0.80	10.16	Zero Insertion Socket	P1	Screw Machine	AB-050-T212Z-P1-M-1	F4306
54	0.80	10.16	Zero Insertion Socket	P9	Screw Machine	AB-054-T212Z-P9-M-1	F4408
54	0.80	10.16	Zero Insertion Socket	P9	Wire Wrap	AB-054-T212Z-P9-W-1	F5311
56	0.50	18.40	Production Socket	A	Screw Machine	AB-056-TS01PS-A-M	F6012
56	0.50	18.40	Production Socket	A	Wire Wrap	AB-056-TS01PS-A-W	F6016
56	0.50	18.40	Production Socket	P2	Screw Machine	AB-056-TS01PS-P2-M-1	F5928
56	0.50	18.40	Production Socket	P2	Wire Wrap	AB-056-TS01PS-P2-W-1	F5910
56	0.50	18.40	Surface Mount	P2	Screw Machine	AB-056-TS01S-P2-M	F4409
56	0.50	18.40	Surface Mount	P2	Wire Wrap	AB-056-TS01S-P2-W	F4493
86	0.50	10.16	Zero Insertion Socket	P4	Screw Machine	AB-086-T232Z-P4-M-1	F6747

PLCC

Pin Count	Lead Pitch (mm)	Tip-to-Tip mm (sq.)	Adapter Top Female Configuration	Bottom Pin Type	ET Part #	Drawing #
84	0.50	PLCC	Zero Insertion Socket	Screw Machine	AB-084-PCC5Z-P12-M-1	F2800
84	0.50	PLCC	Zero Insertion Socket	Wire Wrap	AB-084-PCC5Z-P12-W-1	F2802
84	0.50	PLCC	Production Socket	Screw Machine	AB-084-PCC5-A-M	F2793
84	0.50	PLCC	Production Socket	Wire Wrap	AB-084-PCC5-A-W	F2794
84	0.50	PLCC	Production Socket	Screw Machine	AB-084-PCC5-B-M	F2795
84	0.50	PLCC	Production Socket	Screw Machine	AB-084-PCC5-C-M	F2797
84	0.50	PLCC	Production Socket	Wire Wrap	AB-084-PCC5-C-W	F2798

Try our PLCC Vacuum Insertion Tool

Use this tool to easily insert PLCC packages into their sockets.

Insertor works on PLCC packages with pin counts 28 to 84.

Web Link: www.1800adapter.com/053

For a complete list of prototyping adapters, pricing and delivery information, please see:

Web Link: www.1800adapter.com/004