

IEC Appliance Inlet C14 with Filter, Fuseholder 1- or 2-pole, optional Voltage Selector (step switch)

Plug removal necessary for fuse replacement



Snap-in mounting from front side without voltage selector  
Fuse drawer must be ordered separately (see accessories).



Screw-on mounting from rear side without voltage selector



Screw-on mounting from front side with voltage selector



### Description

- Panel Mount:  
Screw-on version from front or rear side, snap-in version from front side
- 4 Functions:  
Appliance Inlet Protection class I, Fuseholder for fuse-links 5 x 20 mm 1- or 2-pole, with or without voltage selector (step switch), Line filter in standard and medical version
- Quick connect terminals or wires

### Approvals

- VDE Certificate Number: 40004665 (FKE, FKF, FKV, FKW)
- UL File Number: E72928 (FKE, FKF, FKV, FKW)

### Characteristics

- Rear side mounting for efficient cost-saving assembly
- Suitable for assembly in metal plated plastic housings
- All single elements are already wired
- Plug removal necessary for fuse-link replacement
- The fuse drawer "Fingergrip" can be removed by hand
- For added safety "Extra-Safe" fuse drawers are available
- Fuse drawer meets requirements of medical standard IEC/EN 60601-1
- The fuseholder is accessible from the equipment front
- Qualified for use in equipment according IEC/EN 60950

### Other versions on request

- Capacity CX 100 nF

### References

Alternative: version without line filter [KEA](#)  
Alternative: Standard version

### Weblinks

[pdf-datasheet](#), [html-datasheet](#), [General Product Information](#), [Approvals](#), [CE declaration of conformity](#), [RoHS](#), [CHINA-RoHS](#), [Mating Connectors](#), [e-Shop](#), [SCHURTER-Stock-Check](#), [Distributor-Stock-Check](#), [CAD-Drawings](#), [Accessories](#), [Wire Harness](#), [Detailed request for product](#)

### Technical Data

Ratings IEC	1 - 10A @ Ta 40 °C / 250VAC; 50Hz	Appliance-Inlet/-Outlet	C14 acc. to IEC 60320,
Ratings UL/CSA	1 - 10A @ Ta 40 °C / 125VAC; 60Hz		UL 498, CSA C22.2 no. 42 (for cold conditions) pin-temperature 70 °C, 10A, Protection Class I
Leakage Current	standard < 0.5mA (250V / 60Hz) medical < 5 µA (250 V / 60 Hz)	Fuseholder	1 or 2 pole, Shocksafe category PC2 acc. to IEC 60127-6, for fuse-links 5 x 20mm
Dielectric Strength	> 1.7kVDC between L-N > 2.7kVDC between L/N-PE Test voltage (2 sec)	Rated Power Acceptance @ Ta 23 °C	5 x 20: 2W (1 pole)/ 1.6W (2-pole) per pole
Allowable Operation Temp.	-25 °C to 85 °C	Power Acceptance @ Ta > 23 °C	Admissible power acceptance at higher ambient temperature see derating curves
Climatic Category	25/085/21 acc. to IEC 60068-1	Voltage Selectors	optional, step, 3 pos.
Degree of Protection	from front side IP 40 acc. to IEC 60529	Line Filter	Standard and Medical Version, IEC 60939, IEC 60601-1, UL 1283, UL 544, EN 133 200, CSA C22.2 no. 8 <a href="#">Technical Details</a>
Protection Class	Suitable for appliances with protection class I acc. to IEC 61140	MTBF	> 1'700'000h acc. to MIL-HB-217 F
Terminal	Quick connect terminals 6.3 x 0.8 mm Flexible wire AWG18, 150 mm		
Panel Thickness s	Screw: max 8 mm Mounting screw torque max 0.5Nm Snap-in: 0.8mm to 3mm		
Material: Housing	Thermoplastic, black, UL 94V-0		

**Dimensions**

Screw-on mounting from front side

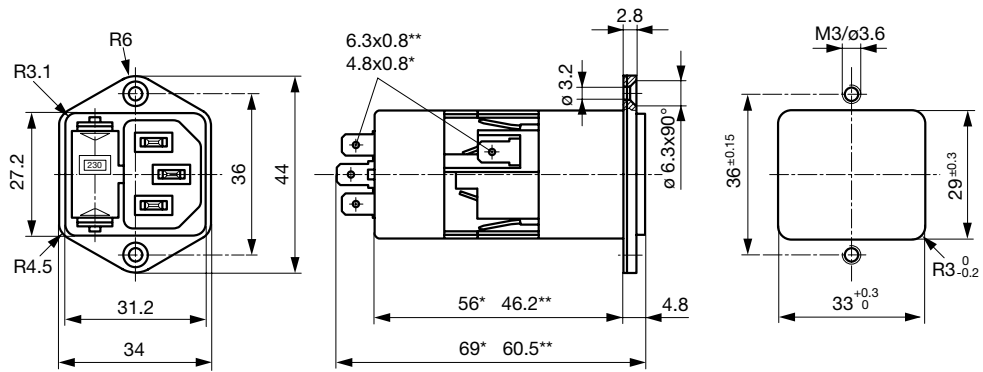

\* with voltage selector

\*\* without voltage selector

Screw-on mounting from rear side

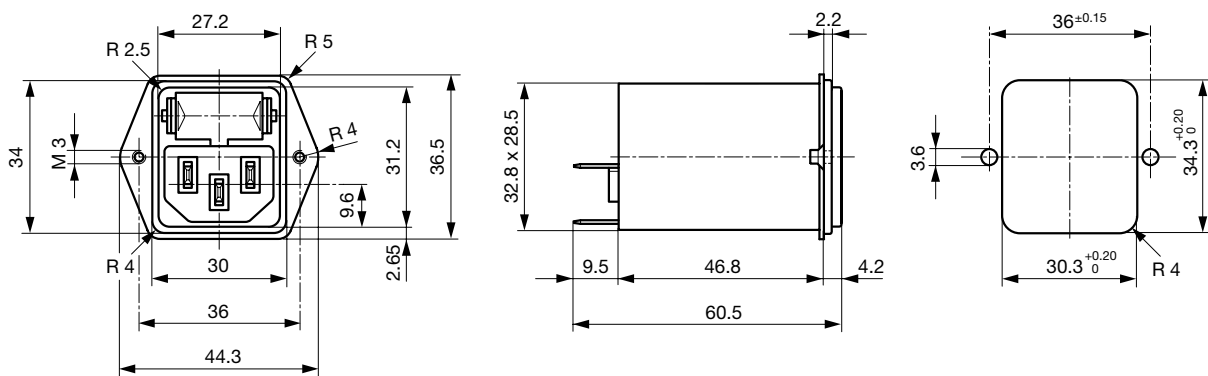

Snap-in mounting

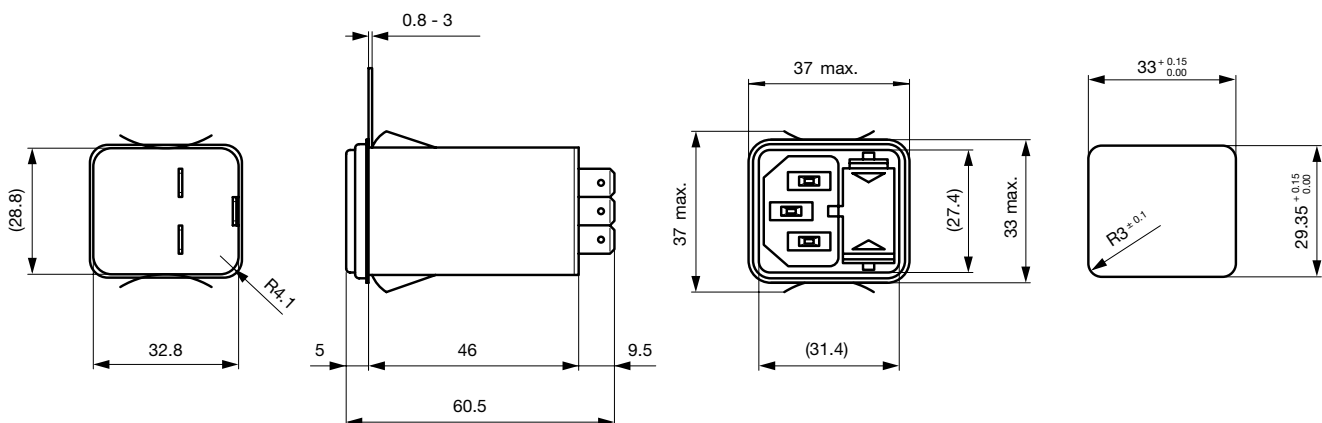

Technical Data of Filter-Components

Rated Current [A]	Filter-Type	Inductances L [mH]	Capacitance CX [nF]	Capacitance CY [nF]	R [MΩ]
1	Standard Version	2 x 10	68	2.2	-
2	Standard Version	2 x 4	68	2.2	-
4	Standard Version	2 x 1.5	68	2.2	-
6	Standard Version	2 x 0.8	68	2.2	-
10	Standard Version	2 x 0.3	68	2.2	-
1	Medical Version (M5)	2 x 10	68	-	1
2	Medical Version (M5)	2 x 4	68	-	1
4	Medical Version (M5)	2 x 1.5	68	-	1
6	Medical Version (M5)	2 x 0.8	68	-	1
10	Medical Version (M5)	2 x 0.3	68	-	1
1	Medical Version (M80)	2 x 10	68	0.47	1
2	Medical Version (M80)	2 x 4	68	0.47	1
4	Medical Version (M80)	2 x 1.5	68	0.47	1
6	Medical Version (M80)	2 x 0.8	68	0.47	1
10	Medical Version (M80)	2 x 0.3	68	0.47	1

Diagrams

Standard version with voltage selector

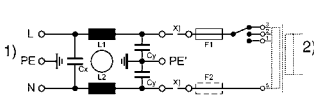

x) external connection to be made by the customer  
1) Line  
2) Load

Medical version with voltage selector

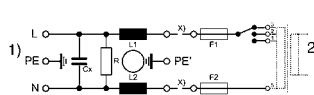

x) external connection to be made by the customer  
1) Line  
2) Load

Standard version without voltage selector

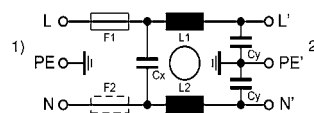

1) Line  
2) Load

Medical version (M5) without voltage selector

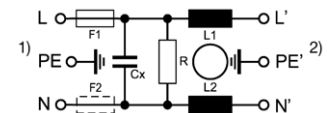

1) Line  
2) Load

Medical version (M80) with voltage selector



x) external connection to be made by the customer  
1) Line  
2) Load

Medical version (M80) without voltage selector

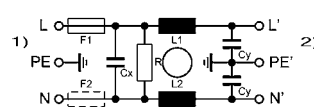

1) Line  
2) Load

Derating Curves

1-pole

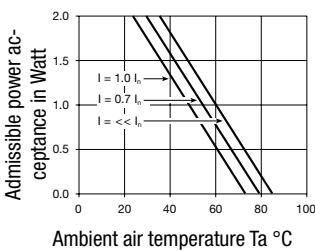

2-pole

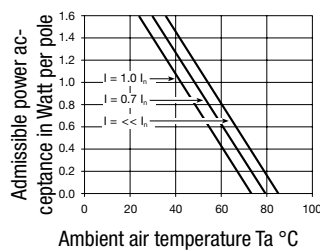

**Attenuation Loss**

Standard version

--- differential mode    — common mode

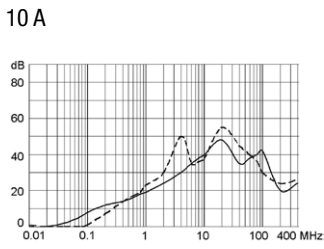
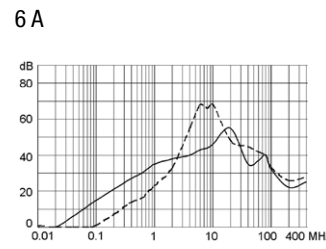
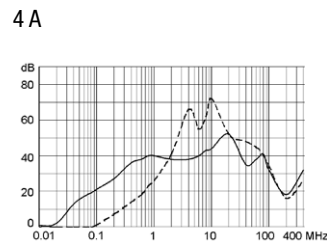
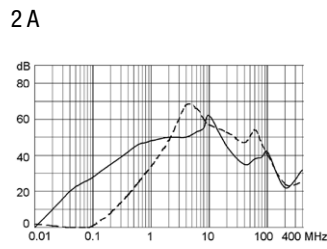
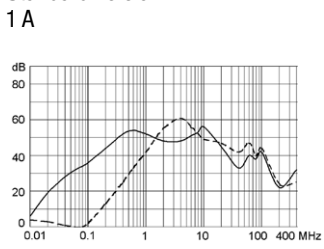

Medical version (M5)

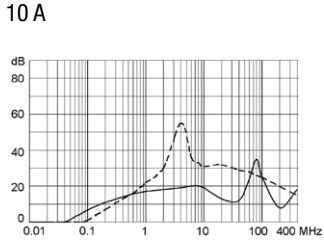
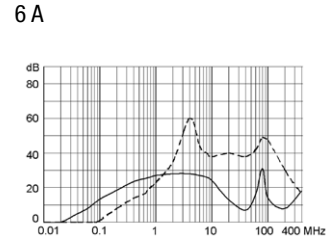
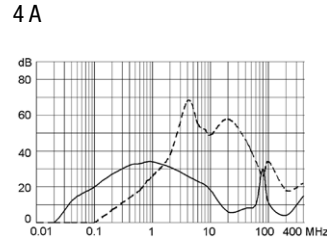
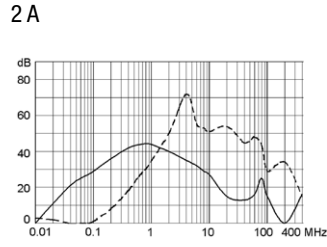
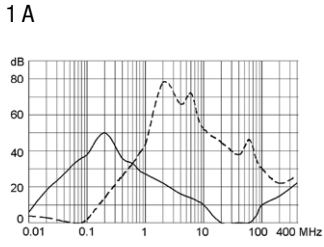

Medical version (M80)

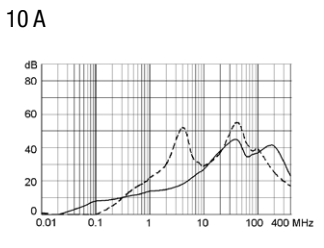
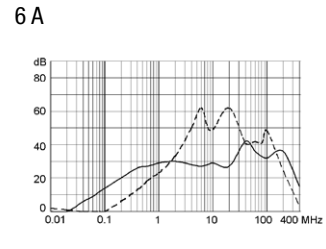
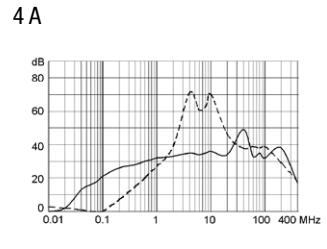
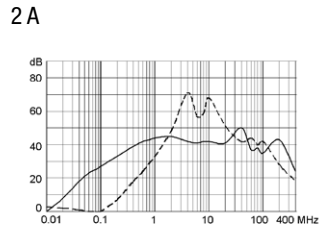
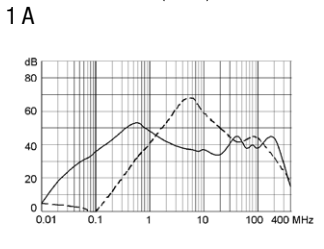

## Variants

Fuse drawer must be ordered separately (see accessories).

Rated Current [A]	Filter-Type	Panel mounting	Mounting side	Fuseholder	Terminal	Voltage Selectors	Order Number
1	Standard Version	Screw	Front-Side	1-pole	Quick connect terminals 6.3 x 0.8 mm	-	4301.5011
1	Standard Version	Screw	Front-Side	1-pole	Quick connect terminals 6.3 x 0.8 mm	3 pos.	4301.5051
1	Standard Version	Screw	Front-Side	2-pole	Quick connect terminals 6.3 x 0.8 mm	-	4301.5001
1	Standard Version	Screw	Front-Side	2-pole	Quick connect terminals 6.3 x 0.8 mm	3 pos.	4301.5041
1	Standard Version	Screw	Rear-Side	2-pole	Quick connect terminals 6.3 x 0.8 mm	-	4301.7001
2	Standard Version	Screw	Front-Side	1-pole	Quick connect terminals 6.3 x 0.8 mm	-	4301.5012
2	Standard Version	Screw	Front-Side	1-pole	Quick connect terminals 6.3 x 0.8 mm	3 pos.	4301.5052
2	Standard Version	Screw	Front-Side	2-pole	Quick connect terminals 6.3 x 0.8 mm	-	4301.5002
2	Standard Version	Screw	Front-Side	2-pole	Quick connect terminals 6.3 x 0.8 mm	3 pos.	4301.5042
2	Standard Version	Screw	Rear-Side	2-pole	Quick connect terminals 6.3 x 0.8 mm	-	4301.7002
4	Standard Version	Screw	Front-Side	1-pole	Quick connect terminals 6.3 x 0.8 mm	-	4301.5013
4	Standard Version	Screw	Front-Side	1-pole	Quick connect terminals 6.3 x 0.8 mm	3 pos.	4301.5053
4	Standard Version	Screw	Front-Side	2-pole	Quick connect terminals 6.3 x 0.8 mm	-	4301.5003
4	Standard Version	Screw	Front-Side	2-pole	Quick connect terminals 6.3 x 0.8 mm	3 pos.	4301.5043
4	Standard Version	Screw	Rear-Side	1-pole	Quick connect terminals 6.3 x 0.8 mm	-	4301.7013
4	Standard Version	Screw	Rear-Side	2-pole	Quick connect terminals 6.3 x 0.8 mm	-	4301.7003
6	Standard Version	Screw	Front-Side	1-pole	Quick connect terminals 6.3 x 0.8 mm	-	4301.5014
6	Standard Version	Screw	Front-Side	1-pole	Quick connect terminals 6.3 x 0.8 mm	3 pos.	4301.5054
6	Standard Version	Screw	Front-Side	2-pole	Quick connect terminals 6.3 x 0.8 mm	-	4301.5004
6	Standard Version	Screw	Front-Side	2-pole	Quick connect terminals 6.3 x 0.8 mm	3 pos.	4301.5044
6	Standard Version	Screw	Rear-Side	1-pole	Quick connect terminals 6.3 x 0.8 mm	-	4301.7014
6	Standard Version	Screw	Rear-Side	2-pole	Quick connect terminals 6.3 x 0.8 mm	-	4301.7004
10	Standard Version	Screw	Front-Side	1-pole	Quick connect terminals 6.3 x 0.8 mm	-	4301.5015
10	Standard Version	Screw	Front-Side	1-pole	Quick connect terminals 6.3 x 0.8 mm	3 pos.	4301.5055
10	Standard Version	Screw	Front-Side	2-pole	Quick connect terminals 6.3 x 0.8 mm	-	4301.5005
10	Standard Version	Screw	Front-Side	2-pole	Quick connect terminals 6.3 x 0.8 mm	3 pos.	4301.5045
10	Standard Version	Screw	Rear-Side	1-pole	Quick connect terminals 6.3 x 0.8 mm	-	4301.7015
10	Standard Version	Screw	Rear-Side	2-pole	Quick connect terminals 6.3 x 0.8 mm	-	4301.7005
1	Standard Version	Snap-in	Front-Side	1-pole	Quick connect terminals 6.3 x 0.8 mm	-	4301.6011
1	Standard Version	Snap-in	Front-Side	2-pole	Quick connect terminals 6.3 x 0.8 mm	-	4301.6001
2	Standard Version	Snap-in	Front-Side	1-pole	Quick connect terminals 6.3 x 0.8 mm	-	4301.6012
2	Standard Version	Snap-in	Front-Side	2-pole	Quick connect terminals 6.3 x 0.8 mm	-	4301.6002
4	Standard Version	Snap-in	Front-Side	1-pole	Quick connect terminals 6.3 x 0.8 mm	-	4301.6013
4	Standard Version	Snap-in	Front-Side	2-pole	Quick connect terminals 6.3 x 0.8 mm	-	4301.6003
6	Standard Version	Snap-in	Front-Side	1-pole	Quick connect terminals 6.3 x 0.8 mm	-	4301.6014
6	Standard Version	Snap-in	Front-Side	2-pole	Quick connect terminals 6.3 x 0.8 mm	-	4301.6004
10	Standard Version	Snap-in	Front-Side	1-pole	Quick connect terminals 6.3 x 0.8 mm	-	4301.6015
10	Standard Version	Snap-in	Front-Side	2-pole	Quick connect terminals 6.3 x 0.8 mm	-	4301.6005
1	Medical Version (M5)	Screw	Front-Side	2-pole	Quick connect terminals 6.3 x 0.8 mm	3 pos.	4301.5241
1	Medical Version (M5)	Screw	Rear-Side	2-pole	Quick connect terminals 6.3 x 0.8 mm	-	4301.7201
2	Medical Version (M5)	Screw	Front-Side	2-pole	Quick connect terminals 6.3 x 0.8 mm	3 pos.	4301.5243
2	Medical Version (M5)	Screw	Rear-Side	2-pole	Quick connect terminals 6.3 x 0.8 mm	-	4301.7203
4	Medical Version (M5)	Screw	Front-Side	2-pole	Quick connect terminals 6.3 x 0.8 mm	3 pos.	4301.5245
4	Medical Version (M5)	Screw	Rear-Side	2-pole	Quick connect terminals 6.3 x 0.8 mm	-	4301.7205
6	Medical Version (M5)	Screw	Front-Side	1-pole	Quick connect terminals 6.3 x 0.8 mm	-	4301.5217
6	Medical Version (M5)	Screw	Front-Side	2-pole	Quick connect terminals 6.3 x 0.8 mm	3 pos.	4301.5247
6	Medical Version (M5)	Screw	Rear-Side	2-pole	Quick connect terminals 6.3 x 0.8 mm	-	4301.7207
10	Medical Version (M5)	Screw	Front-Side	2-pole	Quick connect terminals 6.3 x 0.8 mm	-	4301.5209
10	Medical Version (M5)	Screw	Rear-Side	2-pole	Quick connect terminals 6.3 x 0.8 mm	-	4301.7209
1	Medical Version (M5)	Snap-in	Front-Side	2-pole	Quick connect terminals 6.3 x 0.8 mm	-	4301.6201
2	Medical Version (M5)	Snap-in	Front-Side	2-pole	Quick connect terminals 6.3 x 0.8 mm	-	4301.6203
4	Medical Version (M5)	Snap-in	Front-Side	2-pole	Quick connect terminals 6.3 x 0.8 mm	-	4301.6205
6	Medical Version (M5)	Snap-in	Front-Side	2-pole	Quick connect terminals 6.3 x 0.8 mm	-	4301.6207
1	Medical Version (M80)	Screw	Rear-Side	2-pole	Quick connect terminals 6.3 x 0.8 mm	-	4301.7202

Rated Current [A]	Filter-Type	Panel mounting	Mounting side	Fuseholder	Terminal	Voltage Selectors	Order Number
2	Medical Version (M80)	Screw	Front-Side	2-pole	Quick connect terminals 6.3 x 0.8 mm	3 pos.	4301.5244
2	Medical Version (M80)	Screw	Rear-Side	2-pole	Quick connect terminals 6.3 x 0.8 mm	-	4301.7204
4	Medical Version (M80)	Screw	Front-Side	2-pole	Quick connect terminals 6.3 x 0.8 mm	-	4301.5206
4	Medical Version (M80)	Screw	Rear-Side	2-pole	Quick connect terminals 6.3 x 0.8 mm	-	4301.7206
6	Medical Version (M80)	Screw	Rear-Side	2-pole	Quick connect terminals 6.3 x 0.8 mm	-	4301.7208
10	Medical Version (M80)	Screw	Rear-Side	2-pole	Quick connect terminals 6.3 x 0.8 mm	-	4301.7200
4	Medical Version (M80)	Snap-in	Front-Side	2-pole	Quick connect terminals 6.3 x 0.8 mm	-	4301.6206

Wire lenght: 150 mm

**Packaging unit** 10 Pcs

**Required Accessory**

**Description**



**Fusedrawer 2**  
Fusedrawer with and without Voltage Selector Insert

**Accessories**

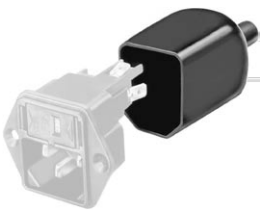

**Assorted Covers**  
Rear Cover



**Wire Harness**  
Wire harness for SCHURTER products



**Cord retaining kits**  
Cord retaining strain relief

Mating Outlets/Connectors

Category / Description

Appliance Outlet Overview complete



IEC Appliance Outlet F, Screw-on Mounting, Front Side, Solder Terminal	4787
IEC Appliance Outlet F, Snap-in Mounting, Front Side, Solder or Quick-connect Terminal	4788
IEC Appliance Outlet F or H, Screw-on Mounting, Front Side, Solder, PCB or Quick-connect Terminal	5091
IEC Appliance Outlet F or H, Screw-on Mounting, Front Side, Solder or Quick-connect Terminal	5092

[Appliance Outlet further types to KFA](#)

Connector Overview complete



IEC Connector C15, Rewireable, Straight	0101
IEC Connector C15A, Rewireable, Straight	0102
IEC Connector C15A, Rewireable, Straight	0102-G
IEC Connector C15A, Rewireable, Angled	0112
IEC Connector C13, Rewireable, Angled	4012

[Connector further types to KFA](#)

Power Cord Overview complete



Power Cord with IEC Connector C13, Angled	0311
Power Cord with IEC Connector C13, Angled	3011
Power Cord with IEC Connector C13, Angled	3012
Power Cord with IEC Connector C13, Angled	3013
Power Cord with IEC Connector C13	3020

[Power Cord further types to KFA](#)