

## Product manual

# Miniature – Push button switches SMS(Surface mount) and PMS(PCB mount).

## CONTENT

### 1. Product Description

SMS/PMS Base module  
SMS/PMS Variable Height

### 2. Technical data and dimensions

Technical data SMS/PMS  
Dimensions SMS/ PMS Base module/Variable Height  
Drilling diagram and Solder pads SMS/PMS Base module /Variable height  
Circuit Diagram SMS/PMS

### 3. Part numbers

Part numbers SMS/PMS Base module/Variable Height

### 4. Packaging

Packaging SMS/PMS Base Module/Variable Height

### 5. Qualification Tests

### 6. ROHS Compliant



Changes that contribute to technical improvement are subject to alternations

| Page   | Production date: | Produced by: | Modification date: | Modified by: | Modification No. | Data sheet No. | Index |
|--------|------------------|--------------|--------------------|--------------|------------------|----------------|-------|
| 1 of 9 | 07.07.2005       | Lickert      | 15.06.2006         | M.Fischer    | 9235             | 105.9513       | -     |

Print date: 6/15/2007 2:39:00 PM

## 1 Description

### 1.1 SMS/PMS Base module

Miniature push button switches with a low height of 4,55 - 4,95 mm for surface mounting (SMS) and PCB mounting (PMS).

The SMS has large flat surfaces on the top side as well as on the other sides, which are also parallel to each other. This makes the SMS a perfect switch for automatic mounting.

The SMS switch is suitable for the SMD soldering process "IR-Reflow".

The switch comes with the SMD-leads "Gullwing and J". With J-leads the switch can be lined up with a spacing of 1/2" in one coordinate direction, and with > 13,5 mm in the other coordinate direction. With Gullwing-leads, the switch can be arranged with a spacing of 1/2" in one coordinate direction, and in the other coordinate direction with > 17,5 mm.

A minimum spacing of 1/2" to 15 mm is necessary for the PCB version.

Basically, the SMS and PMS come in two basic versions concerning the degree of protection. Available are IP 40 and IP 67. According to the degree of protection the IP 40 version is not proof against fluxing and washing, whereas the IP 67 version is. Consequently, the IP 67 version can be exposed to the specified soldering and cleaning processes.

The miniature push button switches feature a very good tactile response with an actuation force of about 2N. SMS and PMS are also available with an elongated actuator. These variants serve as base modules for the SMS/PMS variable height version.

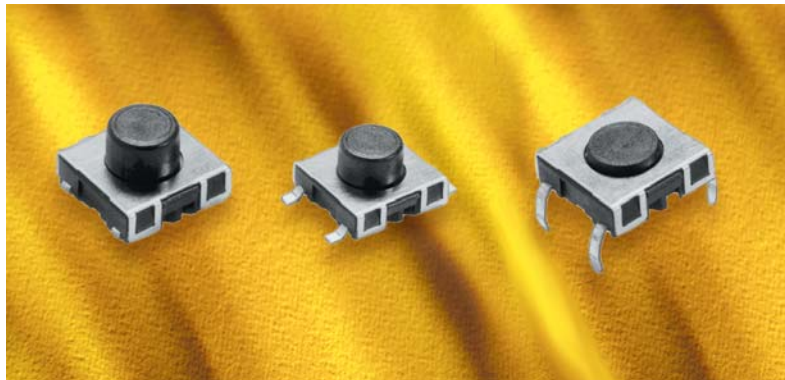

### 1.2 SMS/PMS Variable Height

The variable height SMS/PMS consists of the SMS/PMS base module with elongated actuator and a slip-on button with eight variable heights.

The PMS will be supplied with a mounted button. The button for the SMS has to be ordered separately. After soldering, the button must be put on the base module with elongated actuator.

Heights between 8,5 mm and 13,75 mm for the SMS and 8,35 mm and 13,60 mm for the PMS are available. Depending on the base module being used, degree of protection for the variable height SMS/PMS is IP 40 or IP 67.



Changes that contribute to technical improvement are subject to alternations

| Page   | Production date: | Produced by: | Modification date: | Modified by: | Modification No. | Data sheet No. | Index |
|--------|------------------|--------------|--------------------|--------------|------------------|----------------|-------|
| 2 of 9 | 07.07.2005       | Lickert      | 15.06.2006         | M.Fischer    | 9235             | 105.9513       | -     |

## 2 Data and dimensional drawings

### 2.1 Technical Data SMS/PMS Base module/Variable Height

| <b>Electrical data:</b>                                     | <b>IP40</b>                           | <b>IP67</b>               |
|---|---------------------------------------|---------------------------|
| Contact material  | Gold ; Gold/Silver <sup>(1)</sup>     | Gold                      |
| Switching voltage max.                                      | 30V AC/ 42V DC                        | 30V AC/ 42V DC            |
| Switching current max.                                      | 50 mA                                 | 50 mA                     |
| Rated breaking capacity                                     | 12 V/10 mA                            | 12 V/10 mA                |
| Lifetime (at 12V/10mA)                                      | >1 x 10 <sup>6</sup> cycles           | >1x10 <sup>6</sup> cycles |
| Lifetime (at 24V/80mA)                                      | - ; >1x10 <sup>5</sup> <sup>(1)</sup> | -                         |
| Initial contact resistance new (IEC 512-2 mV-method)        | <50 mOhm                              | <50 mOhm                  |
| Initial contact resistance after 1 x 10 <sup>6</sup> cycles | <150 mOhm                             | <150 mOhm                 |
| Insulation resistance (IEC 512-2)                           | > 1x 10 <sup>8</sup> Ohm              | > 1x 10 <sup>8</sup> Ohm  |
| Contact bounce time   | typ. 0,15 ms                          | typ. 0,15 ms              |

| <b>Mechanical data:</b>                              | <b>IP40</b>                | <b>IP67</b>         |
|--|----------------------------|---------------------|
| Actuating force                                      | 1,8±0,4 N                  | 2,2±0,4 N           |
| Actuating travel                                     | 0,35±0,1 mm                | 0,35±0,1 mm         |
| Mechanical strength (force axial, load 1 min.)       | max. 100 N                 | max. 100 N          |
| Lifetime<br>(IEC 512-5. Test 9a. Actuating force 5N) | >1x 10 <sup>6</sup> cycles | >1x 10 <sup>6</sup> |

| <b>Soldering data:</b>    | <b>SMS<br/>IP40/IP67</b> | <b>PMS<br/>IP40/IP67</b> |
|---------------------------|--------------------------|--------------------------|
| Soldering method          | IR Reflow                | Wave soldering           |
| Soldering heat resistance | 245 °C/5sec.             | 248,5 °C/1sec            |

<sup>(1)</sup> PMS Typ 1241.1652

Changes that contribute to technical improvement are subject to alternations

**Recommended IR-Reflow Profile for SMS**

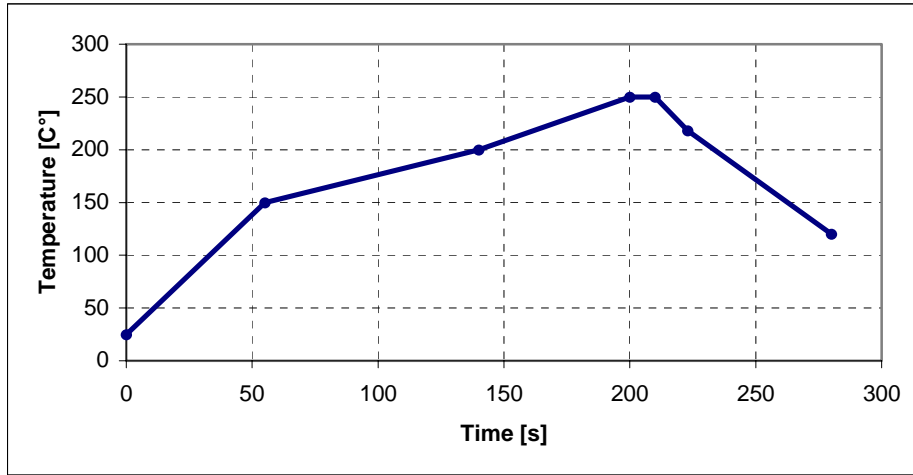

**Tolerance for Temperature settings T +0°C** (according to JEDEC J-STD-020C, July 2004)

Used Solder: Omnix O338 (Sn95.5%/Ag4%/Cu0.5%), Alpha Metals Loetsysteme GmbH

**Recommended Wave Soldering Profile for PMS**

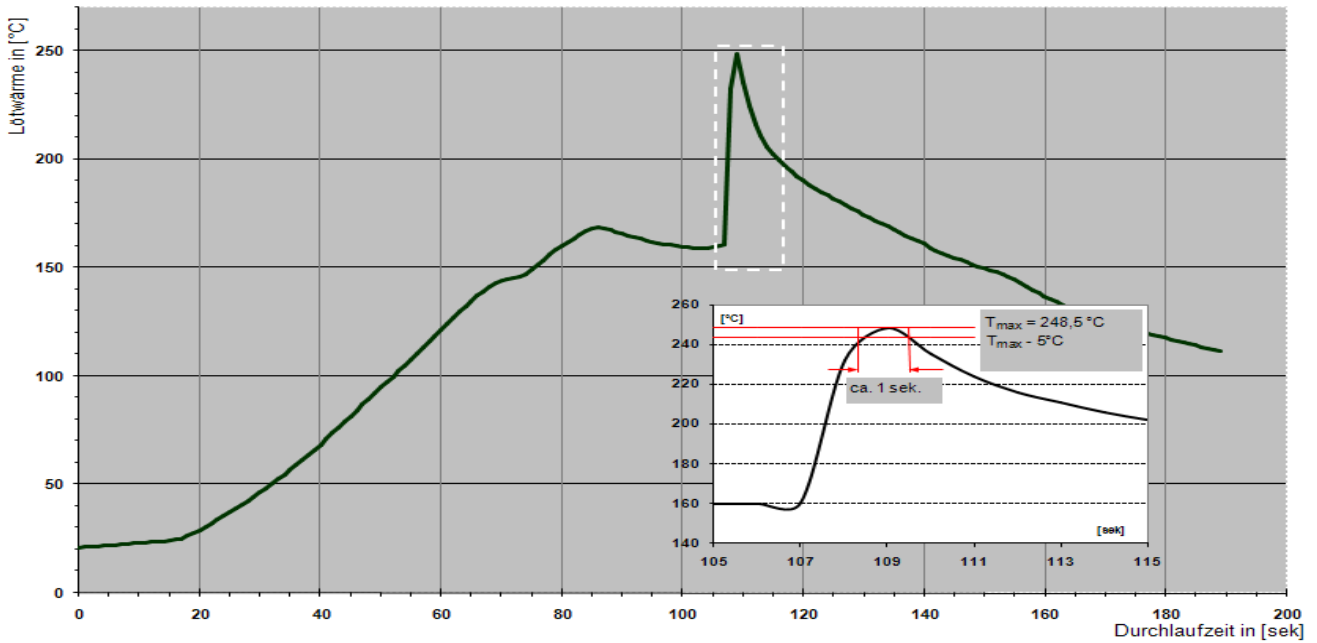

Wave Soldering Equipment: **ERSA EMS 3300**  
 Throughput speed: 1m / min  
 Solder type: Sn100C from Nihon Superior (Balver-Solder)  
 Flux material: AW30 Fa. Otto

**Adjustments Heating Zones**

|              |        |        |        |
|--------------|--------|--------|--------|
| Upper Zone : | 280 °C | 300 °C |        |
| Lower Zone:  | 450 °C | 500 °C | 560 °C |

Changes that contribute to technical improvement are subject to alternations

|        |                  |              |                    |              |                  |                |       |
|--------|------------------|--------------|--------------------|--------------|------------------|----------------|-------|
| Page   | Production date: | Produced by: | Modification date: | Modified by: | Modification No. | Data sheet No. | Index |
| 4 of 9 | 07.07.2005       | Lickert      | 15.06.2006         | M.Fischer    | 9235             | 105.9513       | -     |

| <b>Other data:</b>                                       | <b>SMS</b>  | <b>PMS</b>  | <b>SMS</b>  | <b>PMS</b>  |
|--|-------------|-------------|-------------|-------------|
|  | <b>IP40</b> | <b>IP40</b> | <b>IP67</b> | <b>IP67</b> |
| Operating temperature(°C)                                | -40 to 85   | -40 to 85   | -40 to 85   | -40 to 85   |
| Storage temperature(°C)                                  | -40 to 85   | -40 to 85   | -40 to 85   | -40 to 85   |
| Degree of protection (DIN 40050)                         | IP40        | IP40        | IP67        | IP67        |
| Cleaning agent proof<br>applied test agent <sup>3)</sup> | Zestron     | Zestron     | Zestron     | Zestron     |
| Flux proof <sup>1)</sup>                                 | _____       | _____       | given       | given       |
| Wash proof <sup>2)</sup>                                 | _____       | _____       | given       | given       |

- 1) Visual inspection of switch chamber after immersion in colliophonium solution flux for 3 seconds.  
2) Inspection of switch chamber after washing process  
3) CKW and FCKW free mix made of water soluble Glykoether

| <b>Mechanical data:</b> |                     | <b>SMS/PMS</b>       | <b>SMS/PMS</b>       |
|-------------------------|---------------------|----------------------|----------------------|
| Component               | Flammability rating | <b>IP40</b>          | <b>IP67</b>          |
| Socket                  | UL94 V-0            | Thermoplast (PA 4.6) | Thermoplast (PA 4.6) |
| Actuator                | UL94 V-0            | Thermoplast (PPS)    | Thermoplast (PPS)    |
| Cover plate             |                     | X12 Cr Ni 17 7       | X12 Cr Ni 17 7       |
| Sealing membrane        | UL94 HB             | _____                | VMQ                  |
| Elongated button        | UL94 V-2            | Thermoplast (PC)     | Thermoplast(PC)      |

| <b>Electrical data(material):</b> | <b>SMS/PMS</b>  | <b>SMS/PMS</b> |
|-----------------------------------|---|----------------|
|                                   | <b>IP40</b>   | <b>IP67</b>    |
| Snap dome                         | X12 CrNi 17 7 gold plated on contact side               |                |
| Contacts                          | CuZn37 with Ni/Au coated; with Ag coated <sup>(1)</sup> |                |
| Terminals(leads)                  | CuZn37 with Sn coated                                   |                |

Changes that contribute to technical improvement are subject to alternations

|        |                  |              |                    |              |                  |                |       |
|--------|------------------|--------------|--------------------|--------------|------------------|----------------|-------|
| Page   | Production date: | Produced by: | Modification date: | Modified by: | Modification No. | Data sheet No. | Index |
| 5 of 9 | 07.07.2005       | Lickert      | 15.06.2006         | M.Fischer    | 9235             | 105.9513       | -     |

Print date: 6/15/2007 2:39:00 PM

**2.2 Dimensions SMS/PMS Base module/variable height**

**SMS Gullwing Base module**

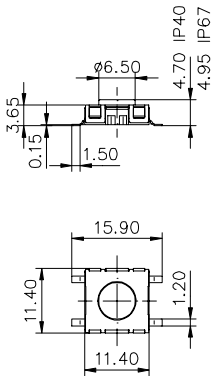

**SMS J-lead Base module**

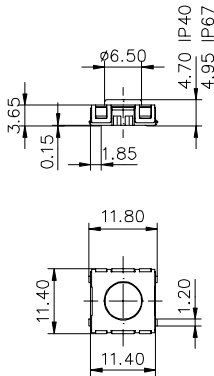

**PMS PCB Base module**

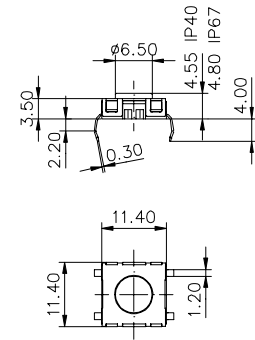

**SMS Gullwing Variable height**

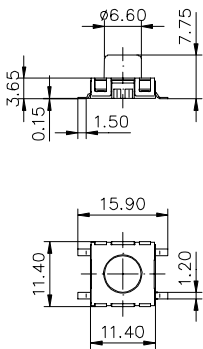

**SMS J-lead Variable height**

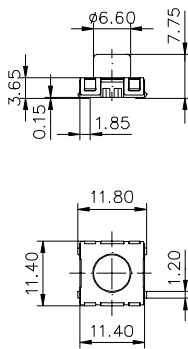

**PMS PCB Variable height**

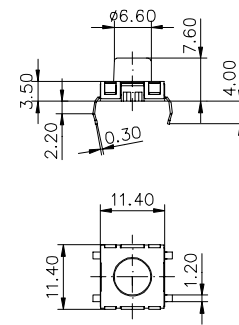

**SMS Gullwing and J lead with elongated button**

**PMS PCB with elongated button**

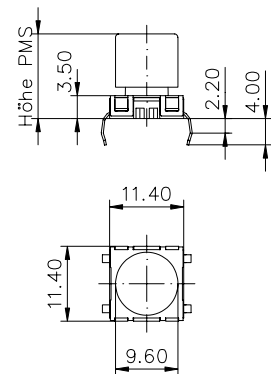
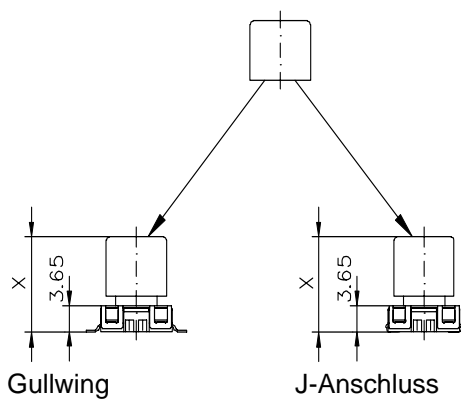

Total height information: **See point 3.1**, Part numbers SMS und PMS Variable height, SMS elongated button must be ordered separately.

Changes that contribute to technical improvement are subject to alternations

|        |                  |              |                    |              |                  |                |       |
|--------|------------------|--------------|--------------------|--------------|------------------|----------------|-------|
| Page   | Production date: | Produced by: | Modification date: | Modified by: | Modification No. | Data sheet No. | Index |
| 6 of 9 | 07.07.2005       | Lickert      | 15.06.2006         | M.Fischer    | 9235             | 105.9513       | -     |

### 2.3 Drilling diagram and Solder pads SMS/PMS Base module/variable height

#### Gullwing lead

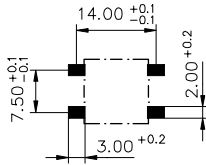

#### J-lead

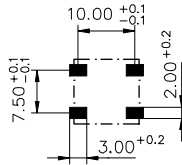

#### PCB lead

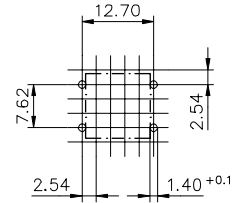

### 2.4 Circuit Diagram SMS/PMS

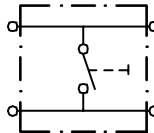

Changes that contribute to technical improvement are subject to alternations

| Page   | Production date: | Produced by: | Modification date: | Modified by: | Modification No. | Data sheet No. | Index |
|--------|------------------|--------------|--------------------|--------------|------------------|----------------|-------|
| 7 of 9 | 07.07.2005       | Lickert      | 15.06.2006         | M.Fischer    | 9235             | 105.9513       | -     |

### 3 Part numbers

#### 3.1 Part numbers SMS/PMS Base module/Variable Height

##### Part-Nr. Base module

| Type              | IP40         | IP67         |
|-------------------|--------------|--------------|
| Gullwing lead     | 1241.1600.XX | 1241.1606.XX |
| J-lead            | 1241.1601.XX | 1241.1607.XX |
| Through hole lead | 1241.1602    | 1241.1608    |

##### Part-Nr. Elongated base module

| Type              | IP40         | IP67         |
|-------------------|--------------|--------------|
| Gullwing lead     | 1241.1612.XX | 1241.1618.XX |
| J-lead            | 1241.1613.XX | 1241.1619.XX |
| Through hole lead | 1241.1614    | 1241.1620    |

##### Ordering example

##### Base module

1241.XXXX.XX

- └─ Index 11 loose in boxes
- └─ Index 23 Blister tape

##### Part-Nr. Variable height PMS

| Height in mm | IP 40       | IP67        | Color  |
|--------------|-------------|-------------|--------|
| 8,35         | 1241.1624.1 | 1241.1625.1 | Yellow |
| 9,10         | 1241.1624.2 | 1241.1625.2 | Orange |
| 9,85         | 1241.1624.3 | 1241.1625.3 | Red    |
| 10,60        | 1241.1624.4 | 1241.1625.4 | Blue   |
| 11,35        | 1241.1624.5 | 1241.1625.5 | Green  |
| 12,10        | 1241.1624.6 | 1241.1625.6 | Grey   |
| 12,85        | 1241.1624.7 | 1241.1625.7 | Black  |
| 13,60        | 1241.1624.8 | 1241.1625.8 | White  |

##### Part-Nr. Elongated buttons for SMS

| Switch height SMS with mounted buttons in mm | Part-Nr.  | Color  |
|--|-----------|--------|
| 8,50   | 0862.8101 | Yellow |
| 9,25   | 0862.8102 | Orange |
| 10,00  | 0862.8103 | Red    |
| 10,75  | 0862.8104 | Blue   |
| 11,50  | 0862.8105 | Green  |
| 12,25  | 0862.8106 | Grey   |
| 13,00  | 0862.8107 | Black  |
| 13,75  | 0862.8108 | White  |

Changes that contribute to technical improvement are subject to alternations

|        |                  |              |                    |              |                  |                |       |
|--------|------------------|--------------|--------------------|--------------|------------------|----------------|-------|
| Page   | Production date: | Produced by: | Modification date: | Modified by: | Modification No. | Data sheet No. | Index |
| 8 of 9 | 07.07.2005       | Lickert      | 15.06.2006         | M.Fischer    | 9235             | 105.9513       | -     |



## 4 Packaging

### 4.1 Packaging SMS/PMS Base module/Variable Height

|  |            |
|--|------------|
| loose in boxes SMS/PMS - Index 11 for SMS            | 100 pieces |
| tape and reel for SMS base module - Index 23         | 700 pieces |
| tape and reel for SMS elonged. base module -Index 23 | 450 pieces |

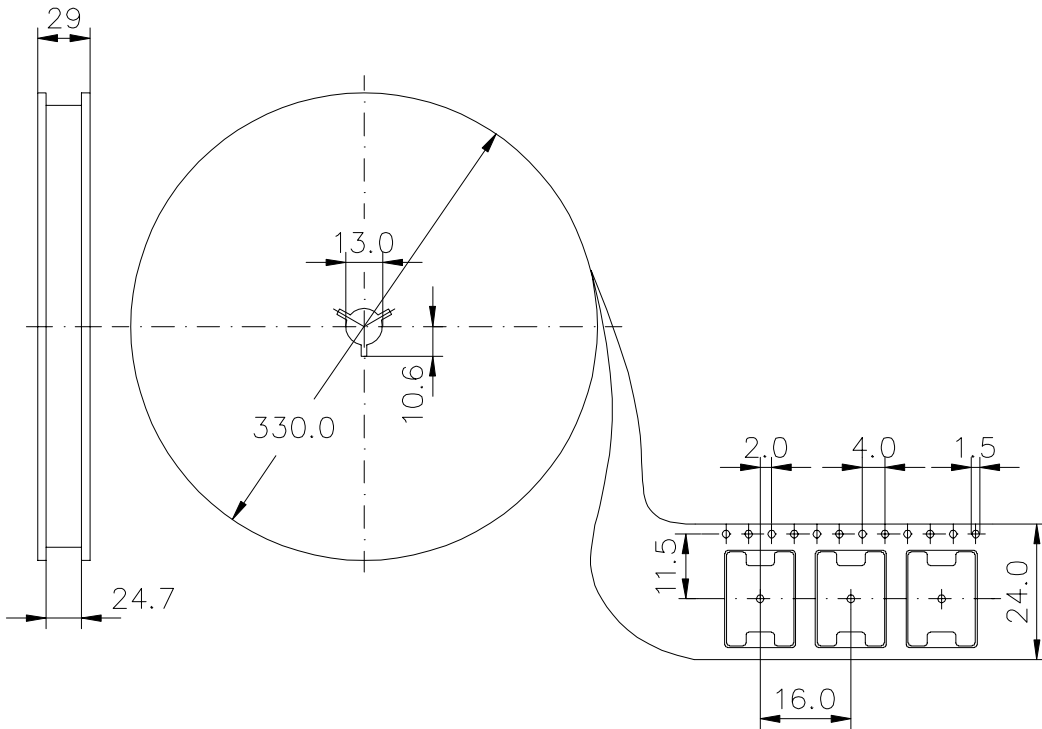

## 5 Qualification Tests

## 6 ROHS Compliant



Changes that contribute to technical improvement are subject to alternations

|        |                  |              |                    |              |                  |                |       |
|--------|------------------|--------------|--------------------|--------------|------------------|----------------|-------|
| Page   | Production date: | Produced by: | Modification date: | Modified by: | Modification No. | Data sheet No. | Index |
| 9 of 9 | 07.07.2005       | Lickert      | 15.06.2006         | M.Fischer    | 9235             | 105.9513       | -     |

Print date: 6/15/2007 2:39:00 PM