

AC Filter 2-Stage, Very High Symmetrical Attenuation

**Description**

- Chassis:
 - Screw-on mounting, from top
- Line-filter in standard version, 2 positions, very high attenuation, broad-band
- Quick connect terminals 6.3 x 0.8 mm or screw terminals
- Especially effective against symmetrical interferences in the frequency range from 10kHz up to 30MHz

Approvals

- VDE Certificate Number: 40004673
- UL File Number: E72928

Characteristics

- Designed for increased requirements
- 2-stage line filter with increased attenuation
 - Protection against interference voltage from the mains
 - Possible interferences generated in the equipment are strongly attenuated
- Especially suitable for use in switching power supplies
 - e.g. in electronic designs with high repetitive switching frequency
- Qualified for use in equipment according IEC/EN 60950

References**Weblinks**

[General Product Information](#), [Approvals](#), [RoHS](#), [CHINA-RoHS](#), [Mating Connectors](#), [e-Store](#), [SCHURTER-Stock-Check](#), [Distributor-Stock-Check](#), [Accessories](#)

Technical Data

Ratings IEC	1 - 16A @ Ta 40 °C / 250VAC; 50Hz
Ratings UL/CSA	1 - 16A @ Ta 40 °C / 125VAC; 60Hz
Leakage Current	industrial < 1.4mA (250V / 60Hz)
Dielectric Strength	> 1.7kVDC between L-N > 2.7kVDC between L/N-PE Test voltage (2 sec)
Allowable Operation Temp.	-25 °C to 100 °C
Climatic Category	25/100/21 acc. to IEC 60068-1
Protection Class	Suitable for appliances with protection class 1 acc. to IEC 61140
Terminal	Quick connect terminals 6.3 x 0.8 mm or screw terminals
Material: Housing	Aluminum

Line Filter	Standard and Industrial Version, IEC 60939, IEC 60601-1, UL 1283, UL 544, EN 133 200, CSA C22.2 no. 8 Technical details
MTBF	> 200'000h acc. to MIL-HB-217 F

Dimensions

Case 10

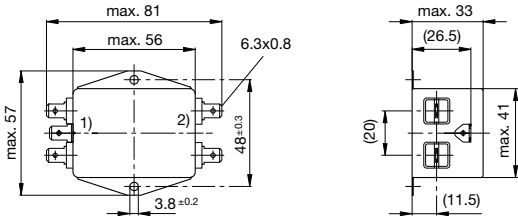

1) Line
2) Load
Case 27

Case 19

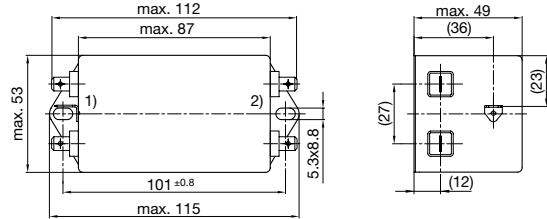

1) Line
2) Load
Case 48

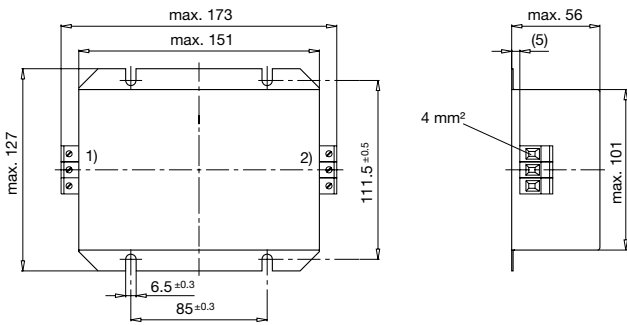

1) Line
2) Load

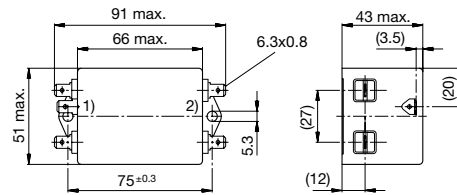

1) Line
2) Load

Diagrams

Standard version

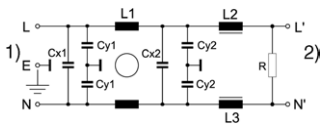

1) Line
2) Load

Attenuation Loss

..... 0.1/100Ω differential mode 100/0.1Ω differential mode - - - differential mode ____ common mode

Standard version

1 A

2 A

3 A

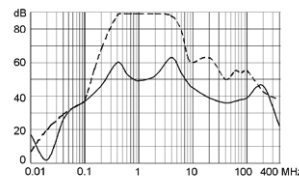
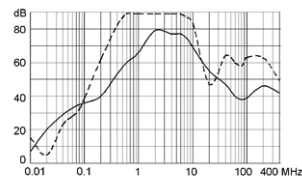
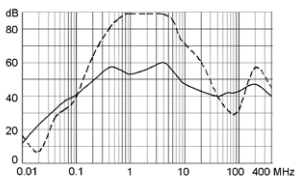

Industrial Version

4 A

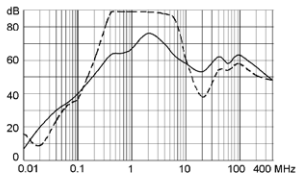

6 A

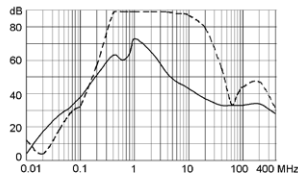

10 A

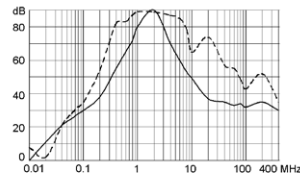

16 A

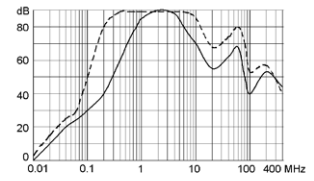

Rated Current [A]	Filter-Type	Leakage Current [mA]	L1 [mH]	L2 [mH]	L3 [mH]	Cx1 [μF]	Cx2 [μF]	Cy1 [nF]	Cy2 [nF]	R [MΩ]	Weight [g]	Housing	Order Number
1	Standard Version	0.25	2 x 15	1	-	0.1	0.47	1.5	1	1	121	10	5500.2051
2	Standard Version	0.25	2 x 10	0.4	0.4	0.1	0.47	1.5	1	1	121	10	5500.2052
3	Standard Version	0.25	2 x 12	1	-	0.1	0.68	1.5	1	1	275	48	5500.2053
4	Industrial Version	1.4	2 x 10	0.8	-	0.1	0.68	10	4.7	1	275	48	5500.2054
6	Industrial Version	1.4	2 x 6	0.5	-	0.1	0.68	10	4.7	1	284	48	5500.2055
10	Industrial Version	1.4	2 x 5	0.2	0.2	0.1	1	10	4.7	1	529	19	5500.2056
16	Industrial Version	1.4	2 x 4	0.2	0.2	0.47	2.2	10	4.7	1	2000	27	5500.2057

Packaging unit 10 Pcs