



1.27 mm SMC Board-on IDC Cable Connectors



1.27 mm SMC Board-on IDC Cable Connectors



Features

- Number of Pins: 12, 26 and 50
- Pitch: 1.27 mm
- Termination
 - PCB: SMT
 - Ribbon cable: IDC
- Tape and reel packaging
- Black insulation body and bright contacts for easy visual recognition
- High temperature resistant thermoplastics for SMT reflow soldering
- Pick and place pad for handling with vacuum nozzle
- Cable Type: AWG 30 (0.635 mm grid)

1.27 mm SMC Board-on IDC Cable Connectors

Assembly Instructions

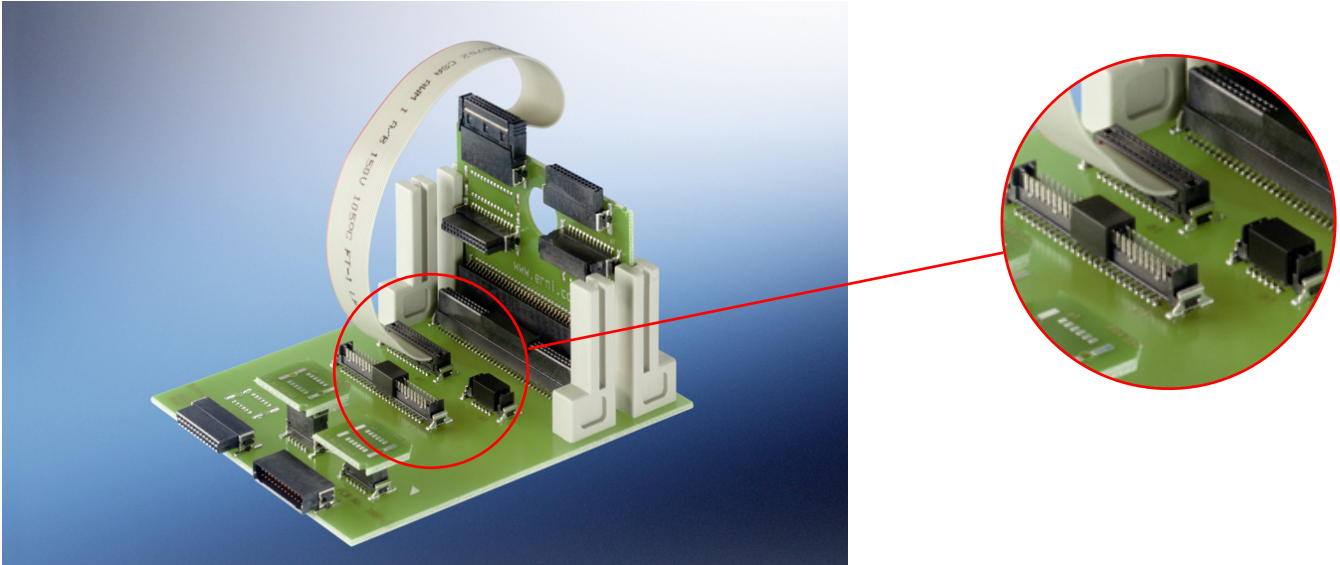

ERNI's Board-on IDC system offers the possibility to optimize cable connections in two ways. The compact size reduces the required area on the board and it is more cost effective than a conventional female – male connection.

Note that the Board-on connector is to be soldered to the PCB before assembling the cable.

ERNI recommends the following:

- A layout proposal indicating the restricted area.
- Use upper and lower tooling to assemble the cable to the connector. Use a flat upper tool which covers the cable guide and is mounted to the press ram and a lower tool that completely supports the area beneath the connector assembly.
- Insert the entire PCB into a fixture for the best results so that one may concentrate on the operation of the press and holding the cable. The fixture should be fixed to the press base and have a method of aligning the PCB within the fixture using the perimeter of the PCB and/or alignment pins.
- Important consideration must be given to the assembly tools available. When using a hand lever press it must be noted that the PCB outside edge (or the fixture edge) to the connector center is smaller than the distance from the throat of the press to the connector center (dimension 'X').
- Adjust the press shut height to 5 mm [.197"]. Additional visual monitoring of a completed assembly is achieved when the recesses are visible and the slot between the cable guide and the connector is evenly shut.

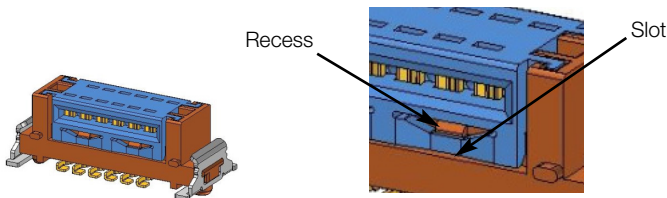
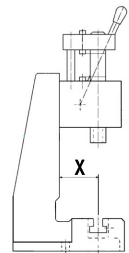

- Neither the PCB nor the components may be bent during the press-in process.
- The flat cable must be inserted in such a way that it protrudes on the end by 0-1 mm.
- The flat cable must be inserted 90° to the connector.

1.27 mm SMC Board-on IDC Cable Connectors

Electrical and Mechanical Characteristics

	Standard	Board-on Connectors with AWG30 flat ribbon cable 250 mm																
Number of Pins		12, 26, 50																
Technical data																		
Climate category	DIN EN 60068-1 test b	-55/125/56																
Temperature range		-55/105 °C																
Current rating per contact	IEC60512 test 5b	By ambient temperature: <table border="1"> <thead> <tr> <th></th> <th>12 pin</th> <th>26 pin</th> <th>50 pin</th> </tr> </thead> <tbody> <tr> <td>20 °C</td> <td>1.8 A</td> <td>1.6 A</td> <td>1.3 A</td> </tr> <tr> <td>70 °C</td> <td>1.1 A</td> <td>1.0 A</td> <td>0.8 A</td> </tr> <tr> <td>100 °C</td> <td>0.4 A</td> <td>0.35 A</td> <td>0.3 A</td> </tr> </tbody> </table>		12 pin	26 pin	50 pin	20 °C	1.8 A	1.6 A	1.3 A	70 °C	1.1 A	1.0 A	0.8 A	100 °C	0.4 A	0.35 A	0.3 A
	12 pin	26 pin	50 pin															
20 °C	1.8 A	1.6 A	1.3 A															
70 °C	1.1 A	1.0 A	0.8 A															
100 °C	0.4 A	0.35 A	0.3 A															
Air – and creepage distance		0.4 mm																
Operating voltage	IEC 60664	The permissible operating voltages depends on the customer application and on the applicable or specified safety requirements. Insulation coordination according to IEC 60664-1 has to be regarded for the complete electrical device. Therefore, the maximum creepage and clearance distances of the mated connectors are specified for consideration as a part of the whole current path. In practice, reductions in creepage or clearance distances may occur due to the conductive pattern of the printed board or the wiring used, and have to be taken into account separately. As a result the creepage and clearance distances for the application may be reduced compared to those of the connector.																
Dielectric strength	IEC 60512 test 4a	contact – contact 500 V _{rms}																
Contact resistance	IEC 60512 test 2a	< 10 mΩ																
Insulation resistance	IEC 60512 test 3a	> 10 ⁴ MΩ																
Vibration, sine	IEC 60512 test 6d	10 – 2000 Hz 20 g																
Contact disturbance (while vibration test)	IEC 60512 test 2e	< 1 μs																
Shock, halfsine	IEC 60512 test 6c	50 g 11 ms																
Contact disturbance (while shock test)	IEC 60512 test 2e	< 1 μs																

1.27 mm SMC Board-on IDC Cable Connectors

Electrical and Mechanical Characteristics

	Standard	Board-on Connectors with AWG30 flat ribbon cable 250 mm
Number of Pins		12, 26, 50
Process-conditions		
Solder temperature max.	IEC 68-2-20	
Hand soldering temperature max.		3.5 s at 350 °C
Dip soldering temperature max.		10 s at 260 °C
Reflow soldering temperature max.	JEDEC J-STD-020C	20 - 40 s at 260 °C
Coplanarity		< 0.1 mm
IDC (Insulation Displacement Connection)		0/55 °C
Housing materials		
Plastic material (symbol)		LCP
CTI value	IEC 112	CTI 175
UL flame rating		UL 94 V-0
UL file		E 83005
Contact materials		
Base material		Cu alloy
IDC termination area		0.5-2 µm Sn over 2-3 µm Ni
PCB termination area		4-6 µm Sn over 2-3 µm Ni
Clip materials		
Base material		Cu alloy
Plating		4-6 µm Sn over 2-3 µm Ni
Environment compatibility		
Recycling		no flame-retardant additives, no toxic additives allows easy recycling

1.27 mm SMC Board-on IDC Cable Connectors

Connectors

Dimensional Drawings

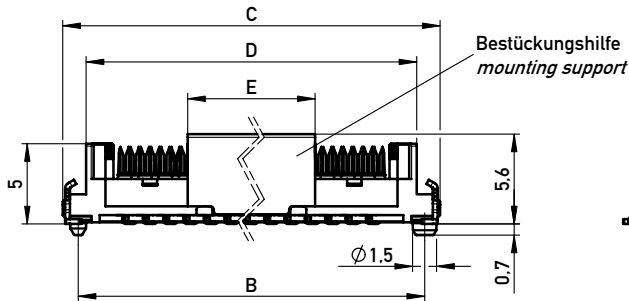

Drahtführung vorverrastet
wire guide loose mounted

Drahtführung verpresst
wire guide pressed on

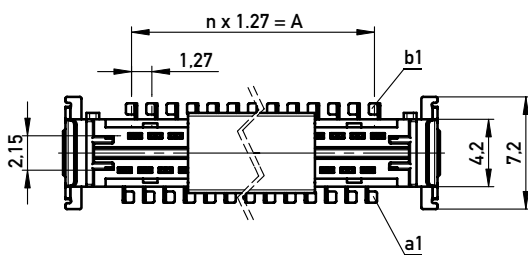
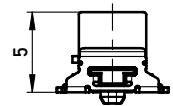
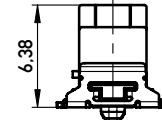
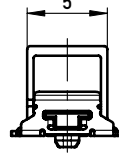

12	6.35	12.77	14.7	11.785	8	11
26	15.24	21.66	23.59	20.675	8	20
50	30.48	36.9	38.83	35.915	8	35
Pohlzahl No. of contacts	A	B	C	D	E	L

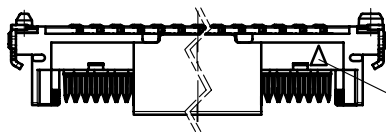

Kontaktbezeichnung bei b1
contact marking at b1

Leiterplatten-Layout Vorschlag für SMT
PCB-Layout Proposal for SMT

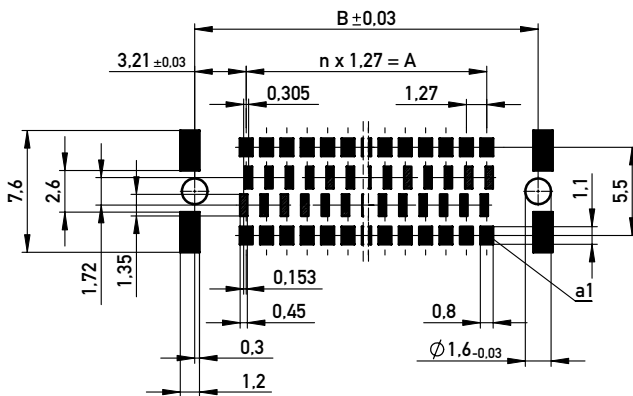

Leiterplatten-Layout Rückseite
PCB-Layout Back Side

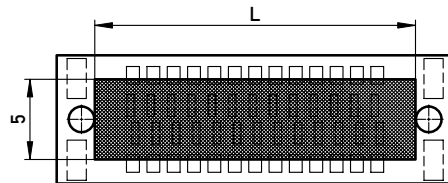

Freifläche L x 5mm auf der Leiterplatten-Unterseite
für das Einpresswerkzeug. Keine Bauteile plazieren
in diesem Bereich.

PCB back side space L x 5mm
for press tool. Do not place any
parts in this space.

■ Sperrfläche
■ Restricted area

1.27 mm SMC Board-on IDC Cable Connectors

Cable Guides

Dimensional Drawings

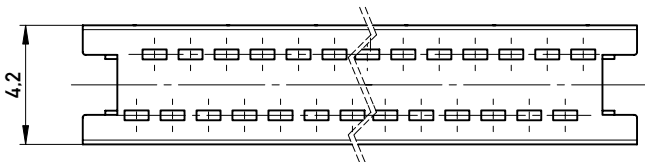
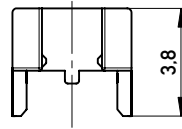
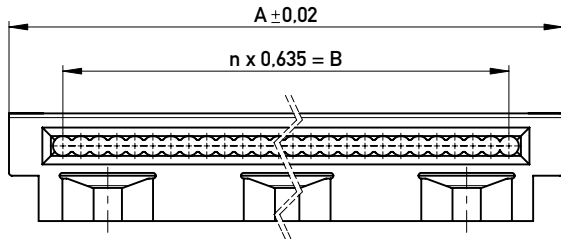

12	10.785	6.985
26	19.675	15.875
50	34.915	31.115
Pohlzahl No. of contacts	A	B

12 Pin Connector

Verpackt in Gurtverpackung - *Tape on Reel Packaging*
 Verpackungseinheit: 280 Stück - *Packaging unit: 280 pcs*

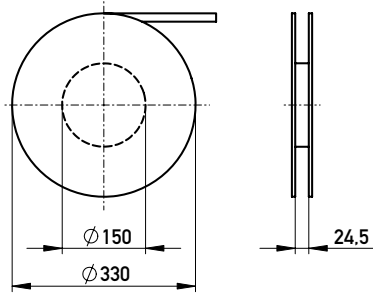

Abspulrichtung - *Reel off Direction* →

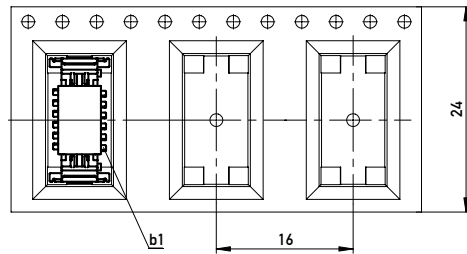

26 Pin Connector

Verpackt in Gurtverpackung - *Tape on Reel Packaging*
 Verpackungseinheit: 280 Stück - *Packaging unit: 280 pcs*

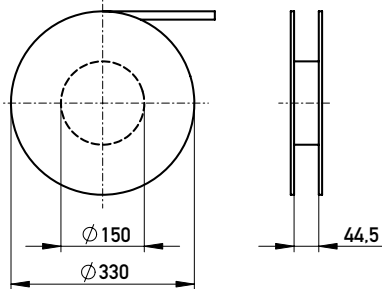

Abspulrichtung - *Reel off Direction* →

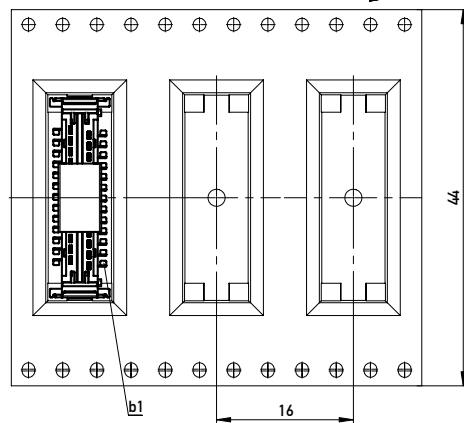

50 Pin Connector

Verpackt in Gurtverpackung - *Tape on Reel Packaging*
 Verpackungseinheit: 280 Stück - *Packaging unit: 280 pcs*

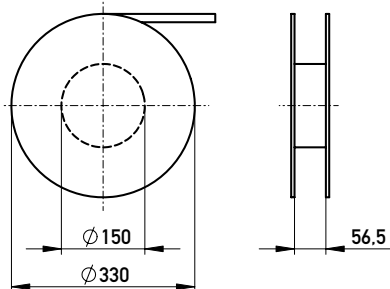

Abspulrichtung - *Reel off Direction* →

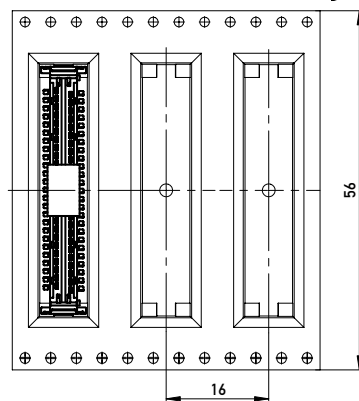

1.27 mm SMC Board-on IDC Cable Connectors

Ordering Information

Configuration	Number of Pins	Termination PCB side	Termination Cable side	Packaging	Part Number
Connector	12	SMT	IDC	Tape and reel/280 pcs	244628
Connector	26	SMT	IDC	Tape and reel/280 pcs	244629
Connector	50	SMT	IDC	Tape and reel/280 pcs	244630
Cable guide	12			Bulk/280 pcs	244631
Cable guide	26			Bulk/280 pcs	244632
Cable guide	50			Bulk/280 pcs	244633



Member





ERNI Electronics GmbH

Seestrasse 9
73099 Adelberg, Germany
Tel +49 7166 50-0
Fax +49 7166 50-282
info@erni.de

Europe South America Africa Japan

ERNI Electronics, Inc.

2201 Westwood Ave
Richmond, VA 23230
Tel +1 804 228-4100
Fax +1 804 228-4099
info.usa@erni.com

North America Canada Mexico

ERNI Asia Holding Pte Ltd.

Blk 4008 Ang Mo Kio Avenue 10
#04-01/02 Techplace I
Singapore 569625
Tel +65 6 555 5885
Fax +65 6 555 5995
info@erni-asia.com

Asia

www.erni.com

© ERNI Electronics GmbH 2008 • Printed in Germany. A policy of continuous improvement is followed and the right to alter any published data without notice is reserved.
ERNI®, MicroStac®, MicroSpeed®, MiniBridge®, MaxiBridge®, ERmet®, ERmet ZD®, ERbic® and ERNIPRESS® are trademarks (registered or applied for in various countries) of ERNI Electronics GmbH.