

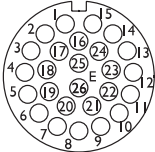
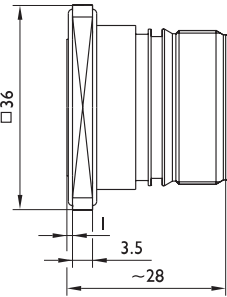
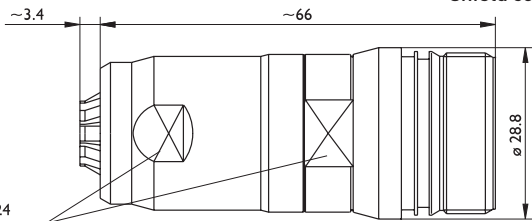
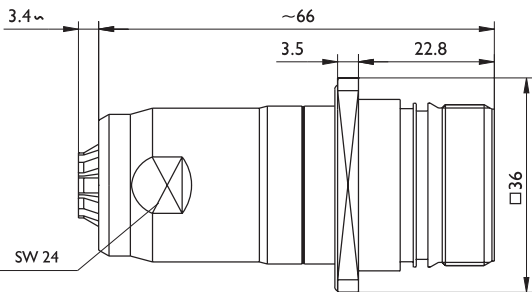

# Signalrundsteckverbinder Serie K Circular signal connectors series K

## Einbaudosen, Kupplungen für 26polige Isolierkörper

## Receptacles, Extensions for 26 way insulation bodies

Darstellung Beschreibung Bestellbezeichnung	layout description part number code	
Einbaudose gerade, mit axialer Abdichtung zum Gerät		<p>26 C (26 x 1)</p>
Bestellbezeichnung inkl. O-Ring als Vibrationsschutz auf Anfrage	<p>straight receptacle, with axial sealing to the device</p> <p>part number incl. O-ring against vibration on demand</p>	KEJA26CMRTN000
		<p><b>inkl. Kontaktstifte</b>      <b>with pins</b></p>
		KEJA26CFRON000
		<p><b>inkl. Kontaktbuchsen</b>      <b>with sockets</b></p>
Kupplung mit variabler Schirmanbindung, Kabelklemmung von $\varnothing$ 7,7 - 14,5 mm		<p>extension with variable shield connection, cable clamp from <math>\varnothing</math> 7.7 to 14.5 mm</p>
Bestellbezeichnung inkl. O-Ring als Vibrationsschutz auf Anfrage	<p>part number incl. O-ring against vibration on demand</p>	KRAA26CMRTN170
		<p><b>inkl. Kontaktstifte</b>      <b>with pins</b></p>
		KRAA26CFRON170
		<p><b>inkl. Kontaktbuchsen</b>      <b>with sockets</b></p>
Kupplung mit Montageflansch, mit variabler Schirmanbindung, Kabelklemmung von $\varnothing$ 7,7 - 14,5 mm		<p>extension with mounting flange, with variable shield connection, cable clamp from <math>\varnothing</math> 7.7 to 14.5 mm</p>
Bestellbezeichnung inkl. O-Ring als Vibrationsschutz auf Anfrage	<p>part number incl. O-ring against vibration on demand</p>	KRRRA26CMRTN170
		<p><b>inkl. Kontaktstifte</b>      <b>with pins</b></p>
		KRRRA26CFRON170
		<p><b>inkl. Kontaktbuchsen</b>      <b>with sockets</b></p>



# Signalrundsteckverbinder Serie K Circular signal connectors series K

## Stecker für 26polige Isolierkörper

## Plugs for 26 way insulation bodies

Darstellung  
Beschreibung  
Bestellbezeichnung

layout  
description  
part number code

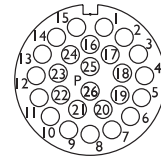

26 D  
(26 x 1)

Stecker mit variabler  
Schirmanbindung,  
Kabelklemmung  
von  $\varnothing 7,7 - 14,5$  mm

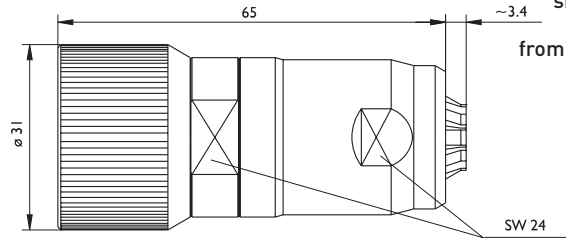

plug with variable  
shield connection,  
cable clamp  
from  $\varnothing 7.7$  to 14.5 mm

KPRA26DMRTN170

inkl. Kontaktstifte with pins

KPRA26DFRON170

inkl. Kontaktbuchsen with sockets

Winkelstecker mit variabler  
Schirmanbindung,  
Kabelklemmung  
von  $\varnothing 7,7 - 14,5$  mm

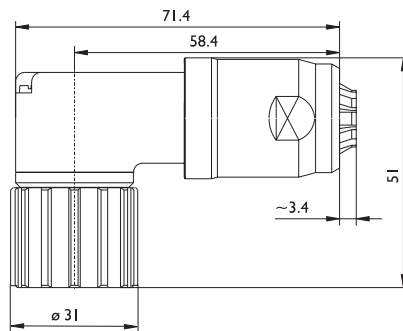

angled plug with variable  
shield connection  
and cable clamp  
from  $\varnothing 7.7$  to 14.5 mm

KPHA26DMRTN170

inkl. Kontaktstifte with pins

KPHA26DFRON170

inkl. Kontaktbuchsen with sockets

Montagefenster für Einbaudose  
mit Montageflansch  
KEJA ...  
26polig

Drilling drawing for receptacle  
with mounting flange  
KEJA ...  
26 way

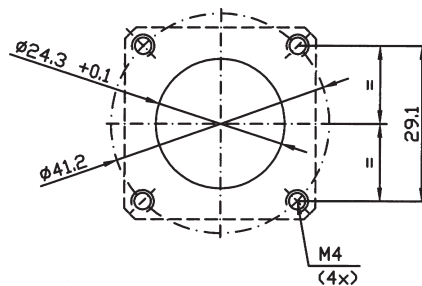

Crimpkontakte siehe Seite 14/15  
crimp contacts are shown on page 14/15

Montagefenster für Kupplung  
mit Montageflansch  
KRRR...  
26polig

Drilling drawing for extension  
with mounting flange  
KRRR ...  
26 way

