

D-Sub Connector
 Dual Port
 Solder pin angled .625"
 (15,88 mm) with threaded lock

Directive 2002/95/EC
 "RoHS"
 Compliant

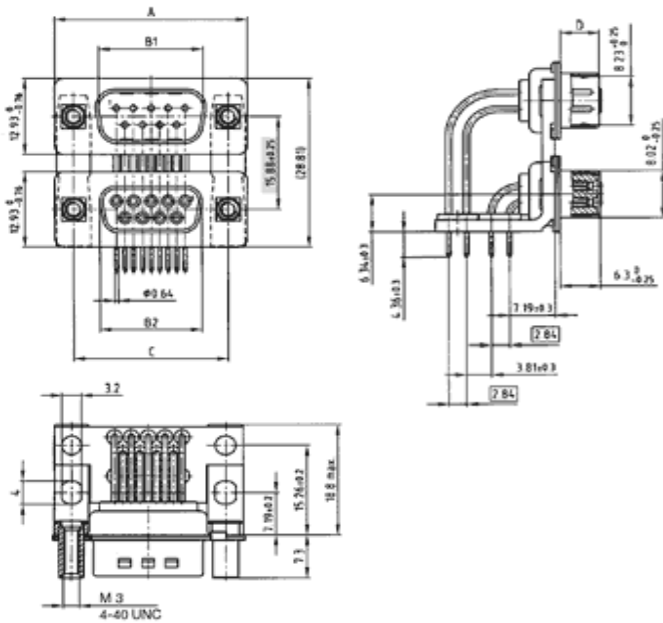

Only one version described

No. of pos.	A -0,76	B+0,25	B-0,25	C	D -0,30
2 x 9	31,19	16,79	16,46	25,00 ^{+0,12} _{-0,13}	6,12
2 x 15	39,52	25,12	24,79	33,30 ^{+0,15} _{-0,10}	6,12
2 x 25	53,42	38,84	38,50	47,04 ^{±0,13}	5,99
2 x 37	69,70	55,30	54,96	63,50 ^{±0,13}	5,99
2 x 50	67,31	52,68	52,55	61,10 ^{+0,14} _{-0,11}	5,99

version 1	plug upper, plug bottom
version 2	plug upper, socket bottom
version 3	socket upper, socket bottom
version 4	socket upper, plug bottom

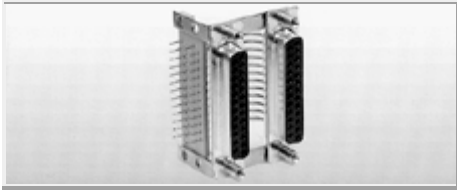

D-Sub Connector
 Dual Port
 Solder pin angled .750"
 (19,05 mm) with threaded lock

Directive 2002/95/EC
 „RoHS“
 Compliant

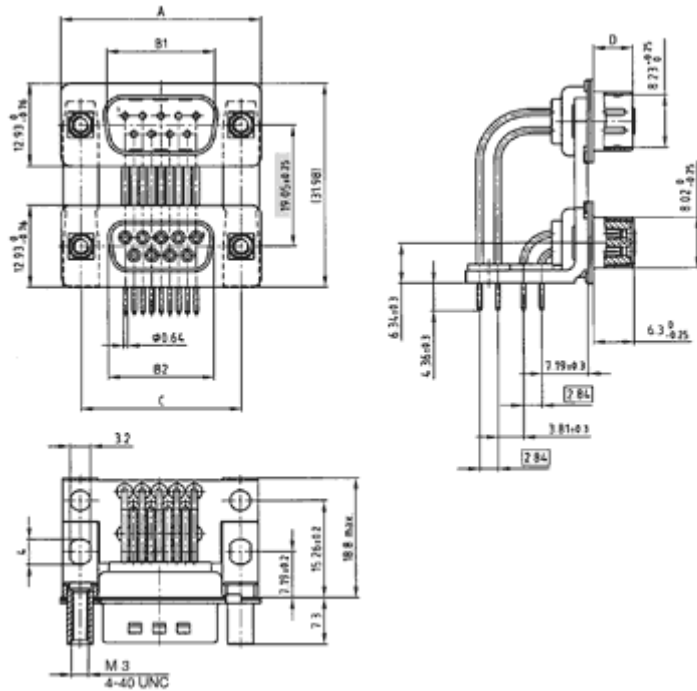

Only one version described

No. of pos.	A -0,76	B+0,25	B-0,25	C	D -0,30
2 x 9	31,19	16,79	16,46	25,00 ^{+0,12} _{-0,13}	6,12
2 x 15	39,52	25,12	24,79	33,30 ^{+0,15} _{-0,10}	6,12
2 x 25	53,42	38,84	38,50	47,04 ^{±0,13}	5,99
2 x 37	69,70	55,30	54,96	63,50 ^{±0,13}	5,99
2 x 50	67,31	52,68	52,55	61,10 ^{+0,14} _{-0,11}	5,99

version 1	plug upper, plug bottom
version 2	plug upper, socket bottom
version 3	socket upper, socket bottom
version 4	socket upper, plug bottom

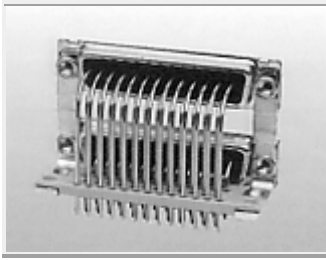

D-Sub Connector
 Dual Port
 Solder pin angled .625"
 (15.88mm) with threaded insert
 and clip

Directive 2002/95/EC
 „RoHS“
 Compliant

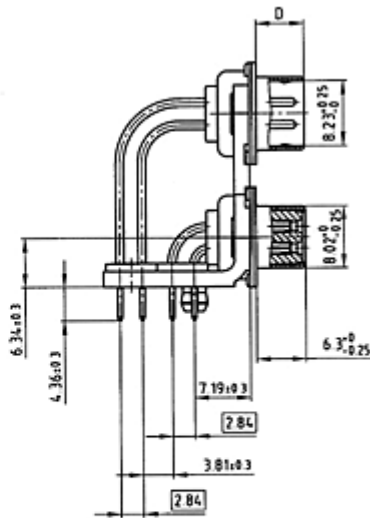
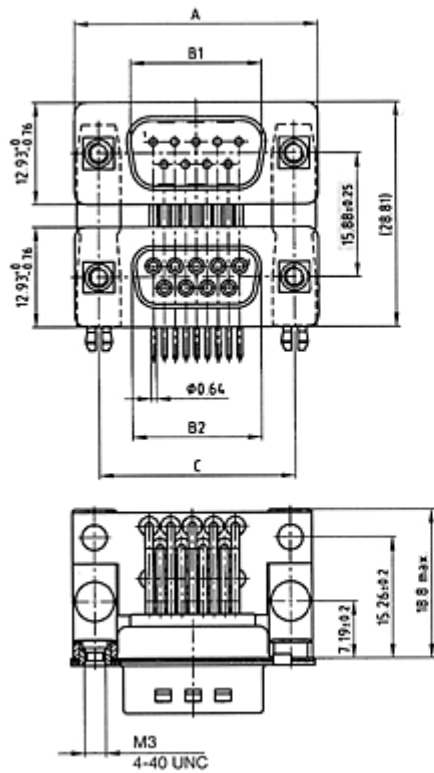

Only one version described

No. of pos.	A - 0,76	B ₁ + 0,25	B ₂ - 0,25	C	D - 0,30
2 x 9	31,19	16,79	16,46	25,00 + 0,12 - 0,13	6,12
2 x 15	39,52	25,12	24,79	33,30 + 0,15 - 0,10	6,12
2 x 25	53,42	38,84	38,50	47,04 ± 0,13	5,99
2 x 37	69,70	55,30	54,96	63,50 ± 0,13	5,99
Version 1	plug upper, plug bottom				
Version 2	plug upper, socket bottom				
Version 3	socket upper, socket bottom				
Version 4	socket upper, plug bottom				

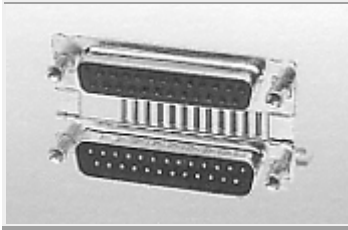

D-sub Connector
 Dual Port
 Solder pin angled .625"
 (15.88mm) with threaded lock
 and clip

Directive 2002/95/EC
 „RoHS“
 Compliant

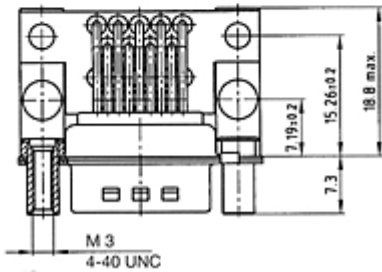
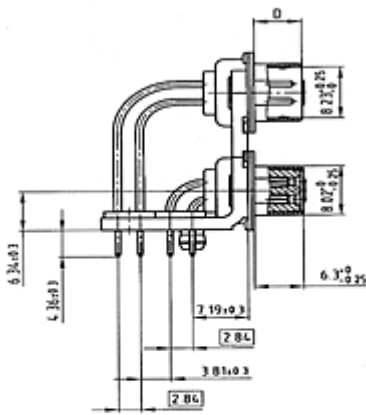
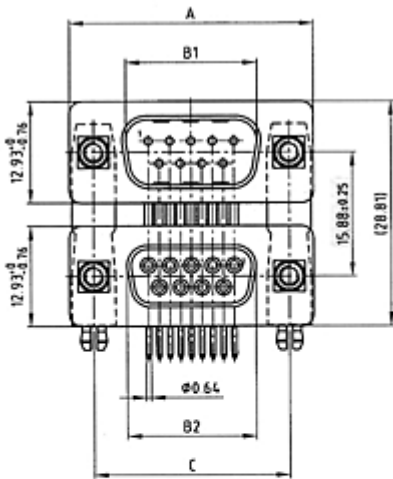

Only one version described

No. of pos.	A ^{-0,76}	B ₁ ^{+0,25}	B ₂ ^{-0,25}	C	D ^{-0,30}
2 x 9	31,19	16,79	16,46	25,00 ^{+0,12 - 0,13}	6,12
2 x 15	39,52	25,12	24,79	33,30 ^{+0,15 - 0,10}	6,12
2 x 25	53,42	38,84	38,50	47,04 ^{±0,13}	5,99
2 x 37	69,70	55,30	54,96	63,50 ^{±0,13}	5,99
Version 1	plug upper, plug bottom				
Version 2	plug upper, socket bottom				
Version 3	socket upper, socket bottom				
Version 4	socket upper, plug bottom				

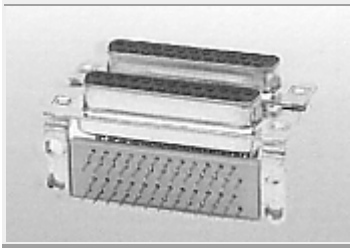

D-Sub Connector
 Dual Port
 Solder pin angled .750"
 (19.05mm) with threaded insert
 and clip

Directive 2002/95/EC
 "RoHS"
 Compliant

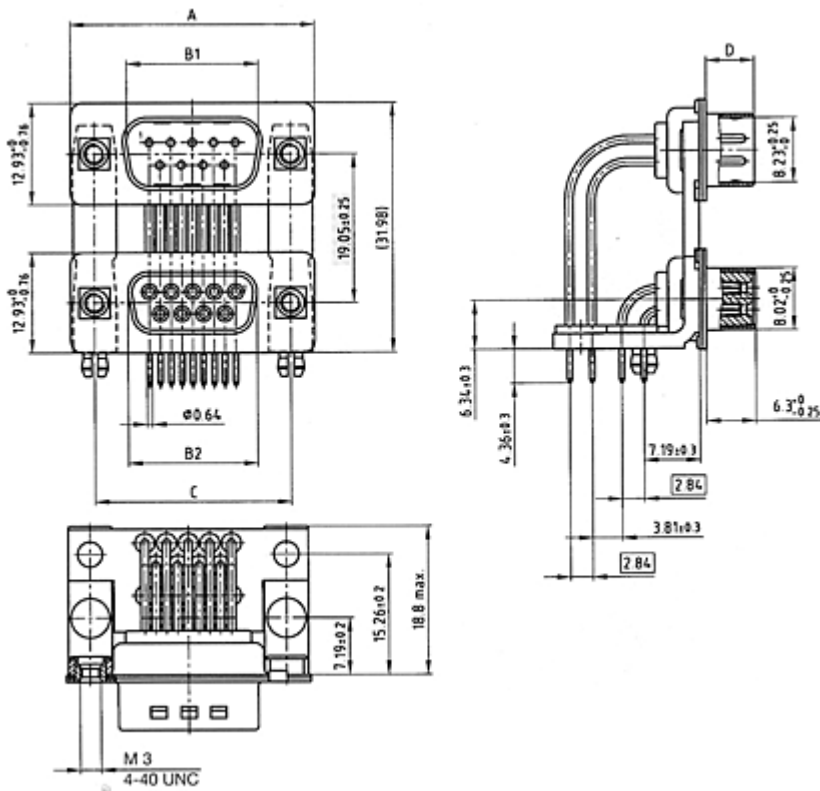

Only one version described

No. of pos.	A - 0,76	B ₁ + 0,25	B ₂ - 0,25	C	D - 0,30
2 x 9	31,19	16,79	16,46	25,00 + 0,12 - 0,13	6,12
2 x 15	39,52	25,12	24,79	33,30 + 0,15 - 0,10	6,12
2 x 25	53,42	38,84	38,50	47,04 ± 0,13	5,99
2 x 37	69,70	55,30	54,96	63,50 ± 0,13	5,99
Version 1	plug upper, plug bottom				
Version 2	plug upper, socket bottom				
Version 3	socket upper, socket bottom				
Version 4	socket upper, plug bottom				

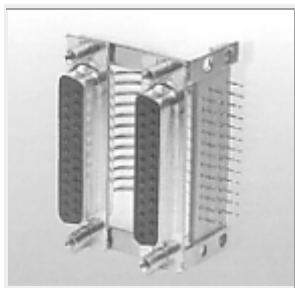

D-Sub Connector
 Dual Port
 Solder pin angled .750"
 (19.05mm) with threaded lock
 and clip

Directive 2002/95/EC
 „RoHS“
 Compliant

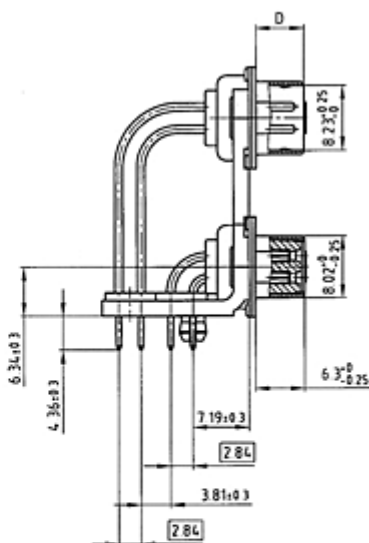
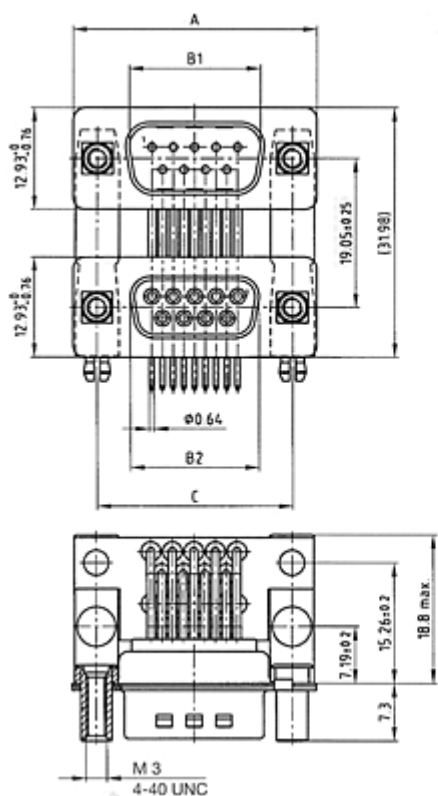

Only one version described

No. of pos.	A - 0,76	B ₁ + 0,25	B ₂ - 0,25	C	D - 0,30
2 x 9	31,19	16,79	16,46	25,00 + 0,12 - 0,13	6,12
2 x 15	39,52	25,12	24,79	33,30 + 0,15 - 0,10	6,12
2 x 25	53,42	38,84	38,50	47,04 ± 0,13	5,99
2 x 37	69,70	55,30	54,96	63,50 ± 0,13	5,99
Version 1	plug upper, plug bottom				
Version 2	plug upper, socket bottom				
Version 3	socket upper, socket bottom				
Version 4	socket upper, plug bottom				

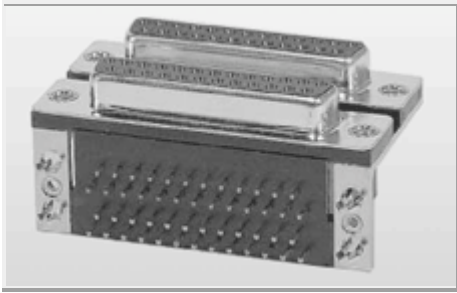

D-Sub Connector
 Dual Port
 Solder pin angled .625" (15.88 mm)
 stamped contacts
 with threaded insert and clip

Directive 2002/95/EC
 „RoHS“
 Compliant

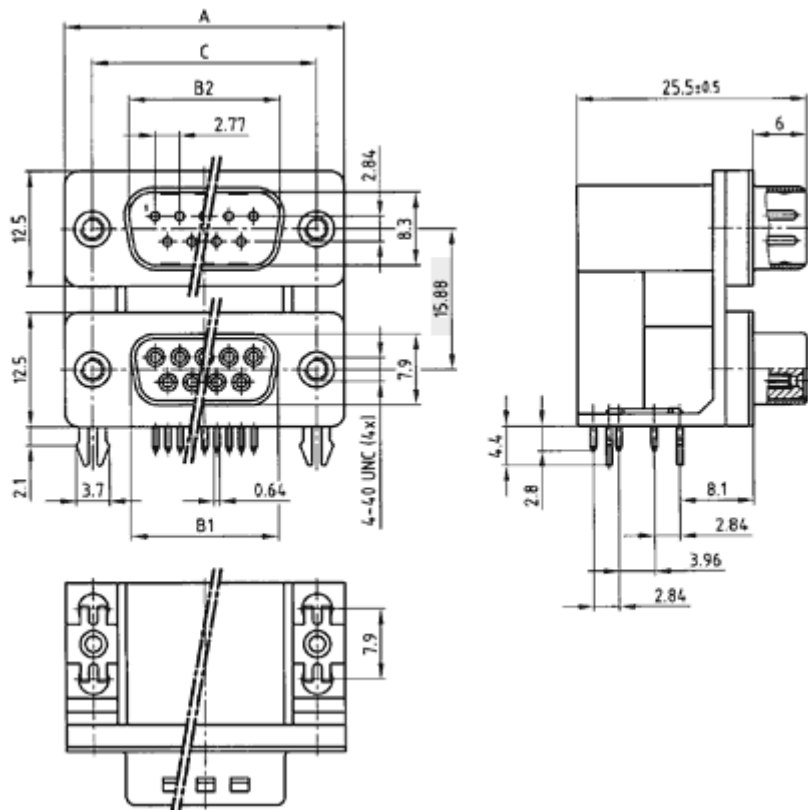

Only one version described

No. of pos.	A	B1	B2	C
2 x 9	30,80	16,30	16,92	25,00
2 x 15	39,20	24,60	25,25	33,30
2 x 25	53,10	38,30	38,96	47,10
2 x 37	69,40	54,80	55,42	63,50

version 1	plug upper, plug bottom
version 2	plug upper, socket bottom
version 3	socket upper, socket bottom
version 4	socket upper, plug bottom



D-Sub Connector
 Dual port
 Solder pin angled .750"
stamped contacts
 with threaded insert and clip

Directive 2002/95/EC
 "RoHS"
 Compliant

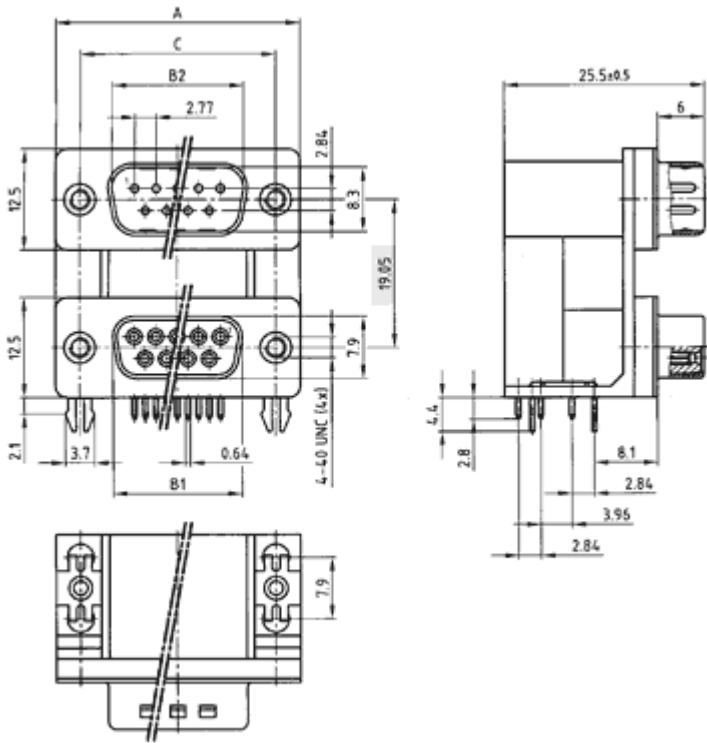

Only one version described

No. of pos.	A	B1	B2	C
2 x 9	30,80	16,30	16,92	25,00
2 x 15	39,20	24,60	25,25	33,30
2 x 25	53,10	38,30	38,96	47,10
2 x 37	69,40	54,80	55,42	63,50

version 1	plug upper, plug bottom
version 2	plug upper, socket bottom
version 3	socket upper, socket bottom
version 4	socket upper, plug bottom