

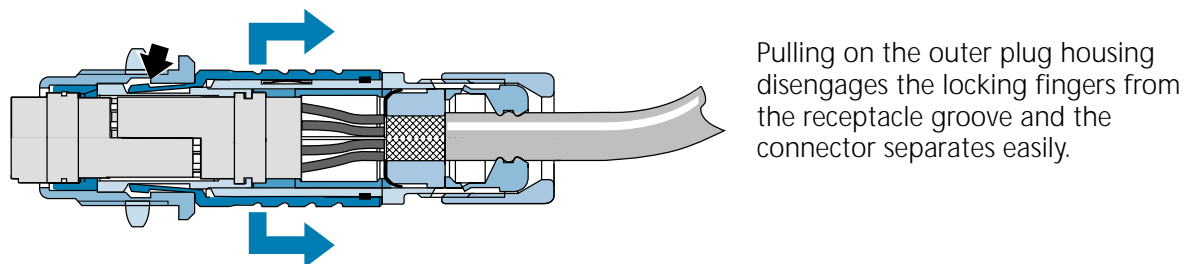

# ODU-MINI-SNAP

Series S - IP50 and IP68  
FP-Locking Concept  
Keying with Insulation Body

## The Push-Pull Locking Principle: FP

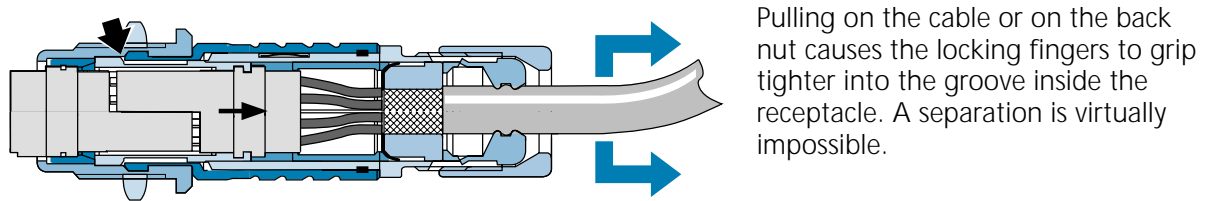
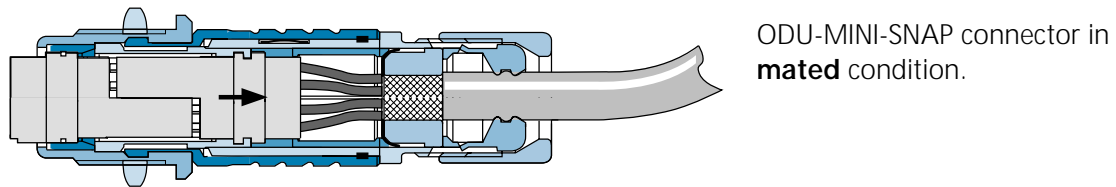
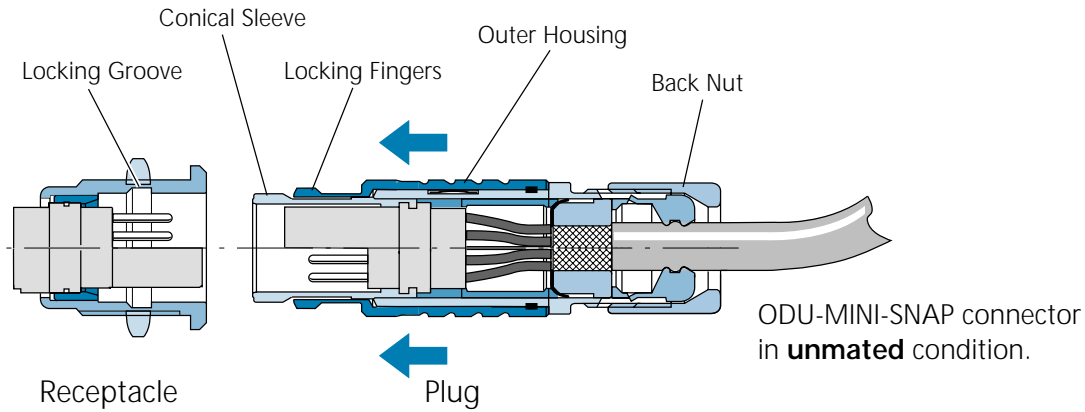

# ODU-MINI-SNAP

with FP-Locking Scheme in Cross Section

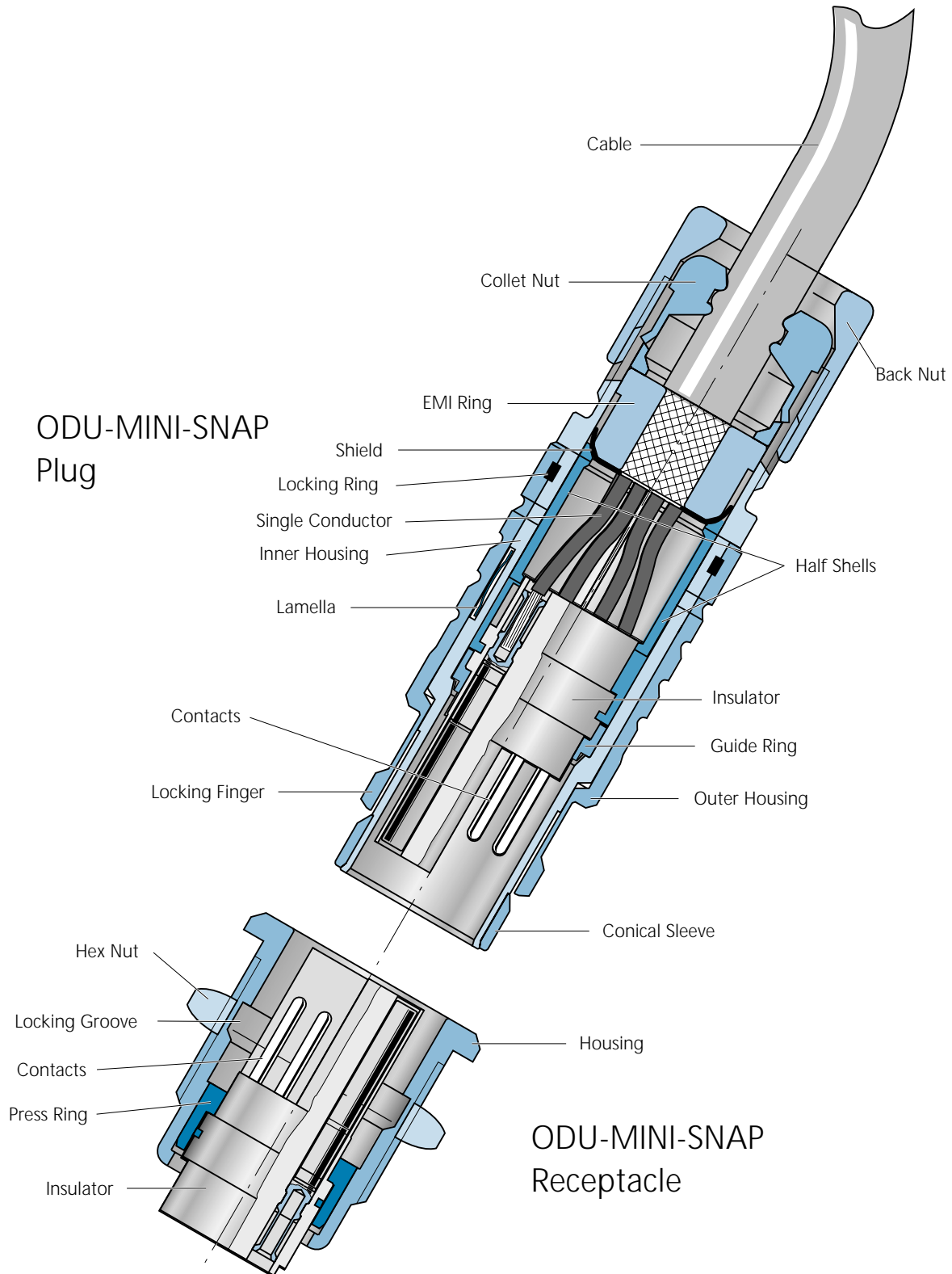



## Available Housing Sizes

(Scale 1 : 1)

**OD** = Outside Diameter (Plug)

**S** = Size

**OD:**

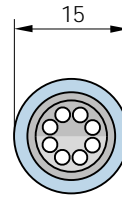
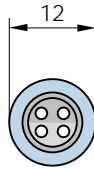
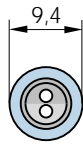

**S:**

0

1

2

## The Part Number Key

### Part Number Key

1	2	3	4	5	6	7	8	9	10	11	12	13	14	15	16	17	18	19
			S	0		-									-			

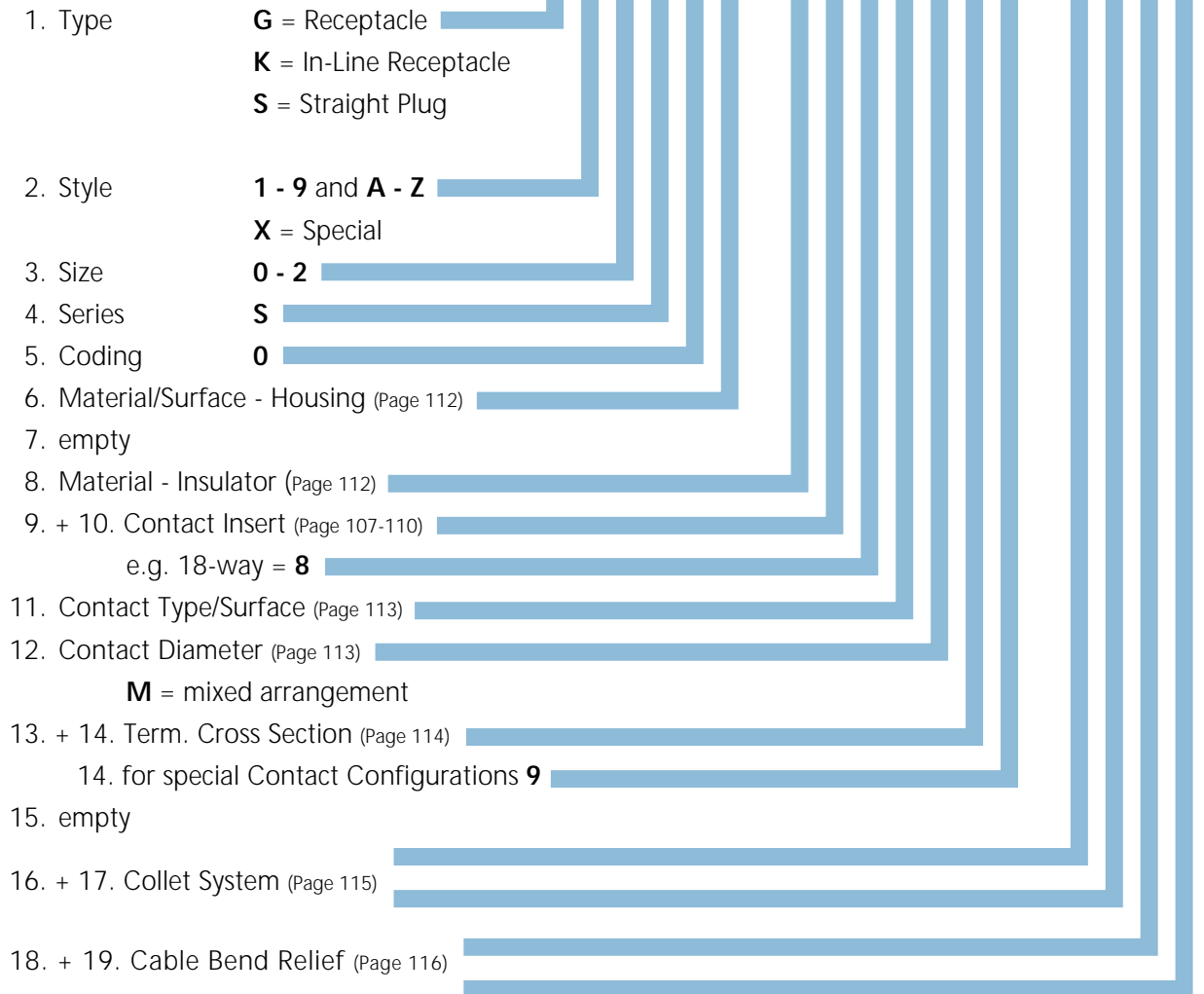

#### Example:

1	2	3	4	5	6	7	8	9	10	11	12	13	14	15	16	17	18	19
G	5	2	S	0	C	-	T	0	8	L	J	G	0	-	0	0	0	0

Receptacle - Style 5 - Size 2 - Series S - Brass matt chromate Housing - PBT Insulator - 8pos. - Socket & Pin (solder) 0,75 µm Au -Term. Cross Section AWG22

1	2	3	4	5	6	7	8	9	10	11	12	13	14	15	16	17	18	19
S	2	2	S	0	C	-	T	0	8	M	J	G	0	-	7	5	E	P

Plug - Style 2 - Size 2 - Series S - Brass matt chromate Housing - PBT Insulator - 8pos. - Pin & Socket (solder) 0,75 µm Au - Term. Cross Section AWG22 - Cable Diameter 7.1-7.5 -Blue Cable Bend Relief - Material PUR

### Part Number Key

1	2	3	4	5	6	7	8	9	10	11	12	13	14	15	16	17	18	19
			S	0		-								-				



### Straight Plug

(Suitable for all following receptacles and in-line receptacles)

- S 1** - IP 50 – with Standard Back Nut
- S 2** - IP 50 – with Back Nut for Cable Bend Relief
- S 3** - IP 68 – watertight with Standard Back Nut
- S 4** - IP 68 – watertight with Back Nut for Cable Bend Relief

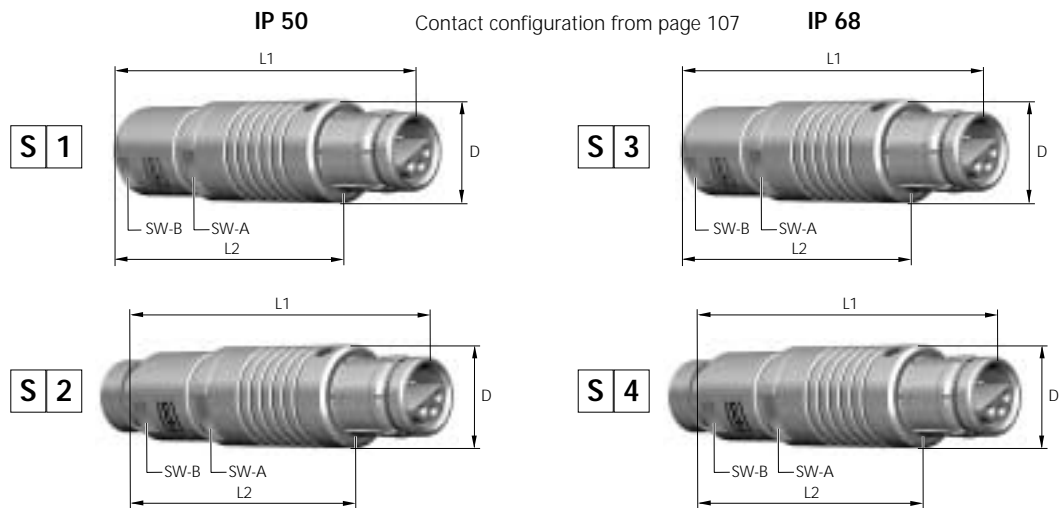

Size	Dimensions in mm				
	L1	L2	D	SW-A	SW-B
0	~ 37	~ 28	9,4	8	7
1	~ 47	~ 35	12	10	10
2	~ 50	~ 38	15	13	12

Size	Dimensions in mm				
	L1	L2	D	SW-A	SW-B
0	~ 40	~ 30	9,4	8	7
1	~ 49	~ 38	12	10	10
2	~ 53	~ 40	15	13	12

### Part Number Key

1	2	3	4	5	6	7	8	9	10	11	12	13	14	15	16	17	18	19
			S			-								-			0	0

**Panel-Mounted Plug**  
**A A** - IP 50 – with hex nut, non latching

(Suitable for all following receptacles and in-line receptacles)

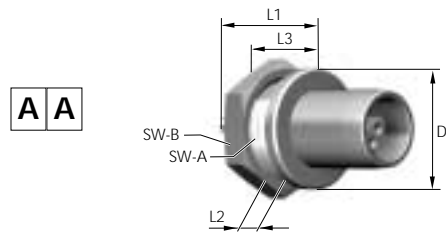

Contact configuration from page 27

Size	Dimensions in mm						 Panel Cut-Out
	L1	L2	L3	D	SW-A	SW-B	
0	17	5,8	24,5	10	8,2	11	SW 8,3 / Ø 9,1
1	22,3	10	29,5	14	10,5	14	SW 10,6 / Ø 12,1
2	23,5	9,7	31,5	18	13,5	17	SW 13,6 / Ø 15,1
3	29	12	33	22	16,5	22	SW 16,6 / Ø 18,1

### Part Number Key

1	2	3	4	5	6	7	8	9	10	11	12	13	14	15	16	17	18	19
			S	0		-								-				



### In-Line Receptacle

- K 1** - IP 50 – with Standard Back Nut
- K 2** - IP 50 – with Back Nut for Cable Bend Relief
- K 3** - IP 68 – watertight with Standard Back Nut
- K 4** - IP 68 – watertight with Back Nut for Cable Bend Relief

#### IP 50

Contact configuration from page 107

#### IP 68

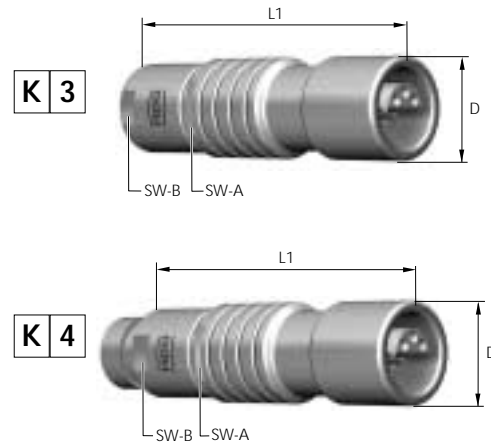
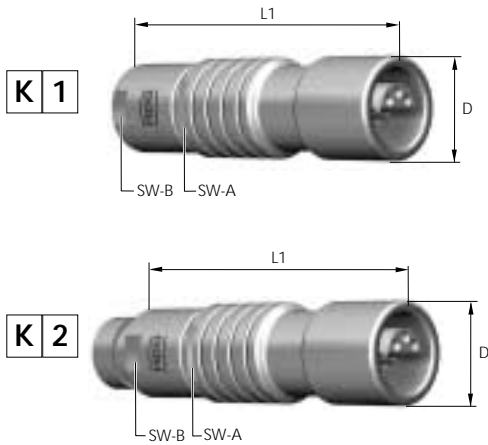

Size	Dimensions in mm			
	L1	D	SW-A	SW-B
0	~ 36	10	8	7
1	~ 43	12	10	10
2	~ 50	15	13	12

Size	Dimensions in mm			
	L1	D	SW-A	SW-B
0	~ 40	10	8	7
1	-	-	-	-
2	~ 51	16	13	12

ODU-MINI-SNAP In-Line Receptacle connect to plug for cable-to-cable connection.

### Part Number Key

1	2	3	4	5	6	7	8	9	10	11	12	13	14	15	16	17	18	19
			S	0		-								-				

<sup>1)</sup> L1 = Maximum Length incl. Contact Insert  
<sup>2)</sup> L3 = Length of Housing

## Receptacle

**G 1** Style 1 – ODU-MINI-SNAP RECEPTACLE IP 50, installation from front of panel

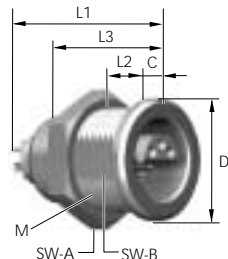

#### Technical Data

- IP 50
- anti-rotation feature
- contact configuration from page 107

Size	Dimensions in mm								Panel Cut-Out
	<sup>1)</sup> L1	L2	<sup>2)</sup> L3	M	D	SW-A	SW-B	C	
0	~19,5	~ 9,0	14,5	9x0,5	10,0	11,0	8,2	1,5	SW 8,3 / Ø 9,1
1	~23,0	~ 8,0	16,5	12x1,0	14,0	14,0	10,0	1,5	SW 10,1 / Ø 12,1
2	~25,5	~10,0	18,5	15x1,0	18,0	17,0	13,5	2,0	SW 13,6 / Ø 15,1

**G 2** Style 2 – ODU-MINI-SNAP WATERTIGHT RECEPTACLE IP 68\*, installation from front of panel

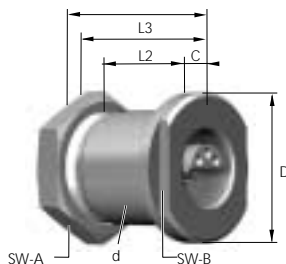

#### Technical Data

- IP 68
- contact configuration from page 107
- distance ring for wall-thickness adjustment, see page 163

Size	Dimensions in mm									Panel Cut-Out
	<sup>1)</sup> L1	<sup>3)</sup> L2	<sup>2)</sup> L3	M	D	SW-A	SW-B	C	d	
2	~27,0	~13,0	23,0	16x1,0	22,0	19,0	17,0	4,0	16,0	Ø 16,1

<sup>3)</sup> Min. wallthickness without using a distance ring

**G 4** Style 4 – ODU-MINI-SNAP WATERTIGHT RECEPTACLE IP 68\*, installation from front of panel with low rear profile

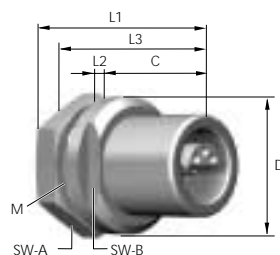

#### Technical Data

- IP 68
- contact configuration from page 107

Size	Dimensions in mm								Panel Cut-Out
	<sup>1)</sup> L1	L2	<sup>2)</sup> L3	M	D	SW-A	SW-B	C	
0	~21,5	~ 4,5	18,5	9x0,5	14,5	11,0	12,0	12,0	SW 8,3 / Ø 9,1
1	~25,0	~ 4,0	22,5	14x1,0	18,0	17,0	14,0	15,5	SW 12,1 / Ø 14,1

\*Reference: Potted Receptacle please see page 183 III.

### Part Number Key

1	2	3	4	5	6	7	8	9	10	11	12	13	14	15	16	17	18	19
				S	0	-								-				

<sup>1)</sup> L1 = Maximum Length incl. Contact Insert

<sup>2)</sup> L3 = Length of Housing



### Receptacle

**G 5**

**Style 5** – ODU-MINI-SNAP RECEPTACLE IP 50, CONTINUOUS THREAD, installation from rear or front of panel. Front extension adjustable

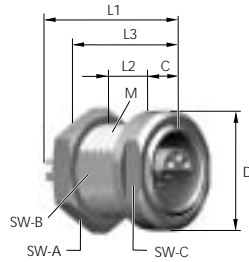

#### Technical Data

- IP 50
- anti-rotation feature
- contact configuration from page 107

Size	Dimensions in mm									Panel Cut-Out
	<sup>1)</sup> L1	L2	<sup>2)</sup> L3	M	D	SW-A	SW-B	SW-C	C	
0	~19,5	~ 8,0	14,5	9x0,5	11,5	11,0	8,2	10,0	2,5	SW 8,3 / Ø 9,1
1	~23,0	~ 7,0	16,5	12x10	15,0	14,0	10,5	13,0	4,0	SW 10,6 / Ø 12,1

**G 6**

**Style 6** – ODU-MINI-SNAP RECEPTACLE IP 50 WITH STRAIN RELIEF, without flange, with two nuts, installation from rear or front of panel

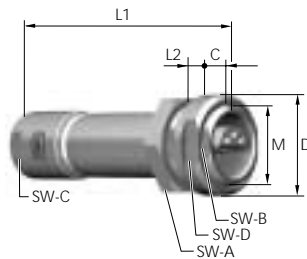

#### Technical Data

- IP 50
- anti-rotation feature
- contact configuration from page 107

Size	Dimensions in mm									Panel Cut-Out
	L1	L2	M	D	SW-A	SW-B	SW-C	SW-D	D	
1	~44,0	~ 4,0	12x1,0	15,0	14,0	10,5	10,0	13,0	4,0	SW 10,6 / Ø 12,1
2	~49,0	~ 7,0	15x1,0	20,0	17,0	13,5	12,0	17,0	4,0	SW 13,6 / Ø 15,1

**G 7**

**Style 7** – ODU-MINI-SNAP RECEPTACLE IP 50, WITH STRAIN RELIEF, installation from front of panel

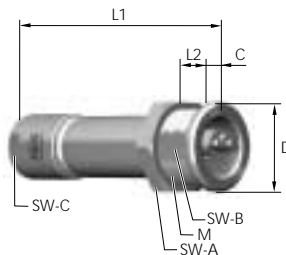

#### Technical Data

- IP 50
- anti-rotation feature
- contact configuration from page 107

Size	Dimensions in mm									Panel Cut-Out
	L1	L2	M	D	SW-A	SW-B	SW-C	C		
0	~36,0	~7,0	9x0,5	10,0	11,0	8,2	7,0	1,5	SW 8,3 / Ø 9,1	

### Part Number Key

1	2	3	4	5	6	7	8	9	10	11	12	13	14	15	16	17	18	19
			S	0		-								-				

<sup>1)</sup> L1 = Maximum Length incl. Contact Insert  
<sup>2)</sup> L3 = Length of Housing

## Receptacle

**G 8** **Style 8** – ODU-MINI-SNAP **WATERTIGHT RECEPTACLE IP 68\***, with slotted nut, installation from rear of panel

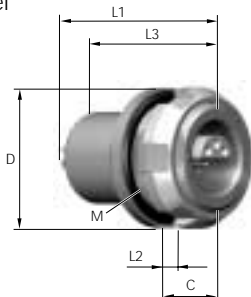

#### Technical Data

- IP 68
- anti-rotation feature
- contact configuration from page 107
- nutdriver for slotted mounting nut see page 168

Size	Dimensions in mm							Panel Cut-Out
	<sup>1)</sup> L1	L2	<sup>2)</sup> L3	M	D	C		
0	~21,5	~ 3,5	18,5	10x0,5	14,5	6,5	SW 9,1 / Ø 10,1	
2	~27,0	~ 3,0	23,0	16x1,0	21,0	8,0	SW 15,1 / Ø 16,1	

**G D** **Style D** – ODU-MINI-SNAP **RECEPTACLE IP 68\***, with round nut, installation from rear of panel

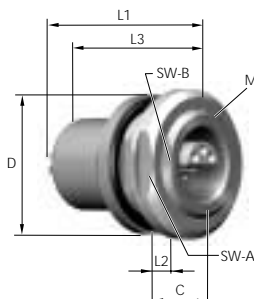

#### Technical Data

- IP 50
- anti-rotation feature
- contact configuration from page 107

Size	Dimensions in mm									Panel Cut-Out
	<sup>1)</sup> L1	L2	<sup>2)</sup> L3	M	D	SW-A	SW-B	C		
0	~22,5	~ 4,0	18,5	10x0,5	14,5	12,0	9,0	6,5	SW 9,1 / Ø 10,1	
2	~29,0	~ 5,0	23,0	16x1,0	21,0	19,0	15,0	8,0	SW 15,1 / Ø 16,1	

**G Q** **Style Q** – ODU-MINI-SNAP **RECEPTACLE IP 50, CONTINUOUS THREAD**, (see style 5, but 2 special nuts) installation from rear or front of panel. Extension in front of panel is adjustable

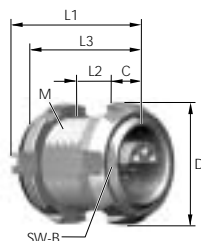

#### Technical Data

- IP 50
- anti-rotation feature
- contact configuration from page 107
- nutdriver for slotted mounting nut, see page 168

Size	Dimensions in mm								Panel Cut-Out
	<sup>1)</sup> L1	L2	<sup>2)</sup> L3	M	D	SW-B	C		
0	~19,5	~ 7,0	14,5	9x0,5	12,0	8,2	3,0	SW 8,3 / Ø 9,1	

\*Reference: Potted Receptacle please see page 183 III.



# Contact Configuration Series S

PCB and solder contacts are factory-installed in the insulation body.  
Crimp contacts are shipped separately.



## Size 0

### Part Number Key

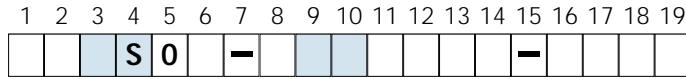

Standard-Polbilder <sup>A)</sup>	Size	Series	Positions	Positions	Contact <sup>2)</sup> Ø mm	Nominal Signal Contact Current Load in A <sup>*</sup>	Test Voltage acc. VDE 0627 <sup>1)</sup>	Terminations <sup>3)</sup>			View on termination side	
								Solder	Crimp <sup>7)</sup>	PCB	Pin Part	Socket
	0	S	0	2	0,9	10	1000 VAC		●			
	0	S	0	3	0,7	7	875 VAC	●				
	0	S	0	4	0,7	7	875 VAC	●				

<sup>1)</sup> In most cases the operating voltage according to MIL-STD-1344, Method 3001 is twice as high as according to VDE.

<sup>2)</sup> Termination cross section see page 114

<sup>3)</sup> Termination and surface see page 113

<sup>7)</sup> Tools for assembly see page 165 to 168

\* Derating Factor see page 186

<sup>A)</sup> Standard Contact Configuration (compatible with other manufacturers)









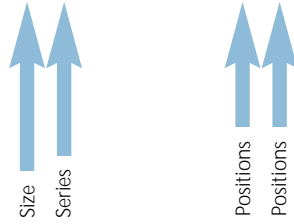
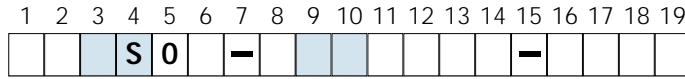















➔ **Crimp and Print Termination on request**

Coaxial and triaxial connectors please see on page 146

# Size 1

## Part Number Key



Standard-Polbilder <sup>A)</sup>	Terminations <sup>3)</sup>		Contact <sup>2)</sup> Ø mm	Nominal Signal Contact Current Load in A*	Test Voltage acc. VDE 0627 <sup>1)</sup>	Solder <sup>7)</sup>	Crimp <sup>7)</sup>	PCB	View on termination side	
	Pin Part	Socket								
			2,0	22	1000 VAC	●				
			1,3	14	1000 VAC	●				
			0,9	10	1000 VAC	●				
			0,9	10	1000 VAC	●	●			
			2x0,9 3x0,7	10 7	1000 VAC	●				
			0,7	7	1000 VAC	●				

<sup>1)</sup> In most cases the operating voltage according to MIL-STD-1344, Method 3001 is twice as high as according to VDE.

<sup>2)</sup> Termination cross section see page 114

<sup>3)</sup> Termination and surface see page 113

<sup>7)</sup> Tools for assembly see page 165 to 168

\* Derating Factor see page 186

<sup>A)</sup> Standard Contact Configuration (compatible with other manufacturers)

➔ Crimp and Print Termination on request

Coaxial and triaxial connectors please see on page 146

## Size 2

### Part Number Key

1	2	3	4	5	6	7	8	9	10	11	12	13	14	15	16	17	18	19
		S	0															

	Size	Series	Positions	Positions	Contact <sup>2)</sup> Ø mm	Nominal Signal Contact Current Load in A *	Test Voltage acc. VDE 0627 <sup>1)</sup>	Terminations <sup>3)</sup>			View on termination side	
								Solder	Crimp <sup>7)</sup>	PCB	Pin Part	Socket
Standard Contact Configuration <sup>A)</sup>	2	S	0	2	1,6	17	1500 VAC	●				
	2	S	0	4	1,3	14	1250 VAC	●	●			
	2	S	0	5	1,3	14	1250 VAC	●				
	2	S	0	6	1,3	14	1250 VAC	●				
	2	S	0	8	0,9	10	875 VAC	●	●			
	2	S	1	0	0,9	10	875 VAC	●	●			

<sup>1)</sup> In most cases the operating voltage according to MIL-STD-1344, Method 3001 is twice as high as according to VDE.

<sup>2)</sup> Termination cross section see page 114

<sup>3)</sup> Termination and surface see page 113

<sup>7)</sup> Tools for assembly see page 165 to 168

\* Derating Factor see page 186

<sup>A)</sup> Standard Contact Configuration (compatible with other manufacturers)

→ Crimp and Print Termination on request

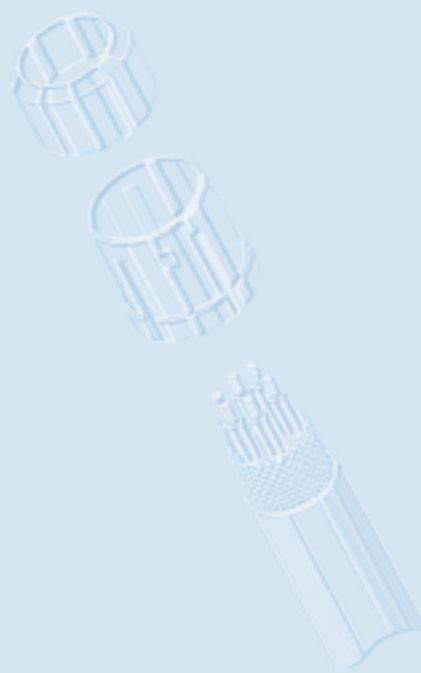
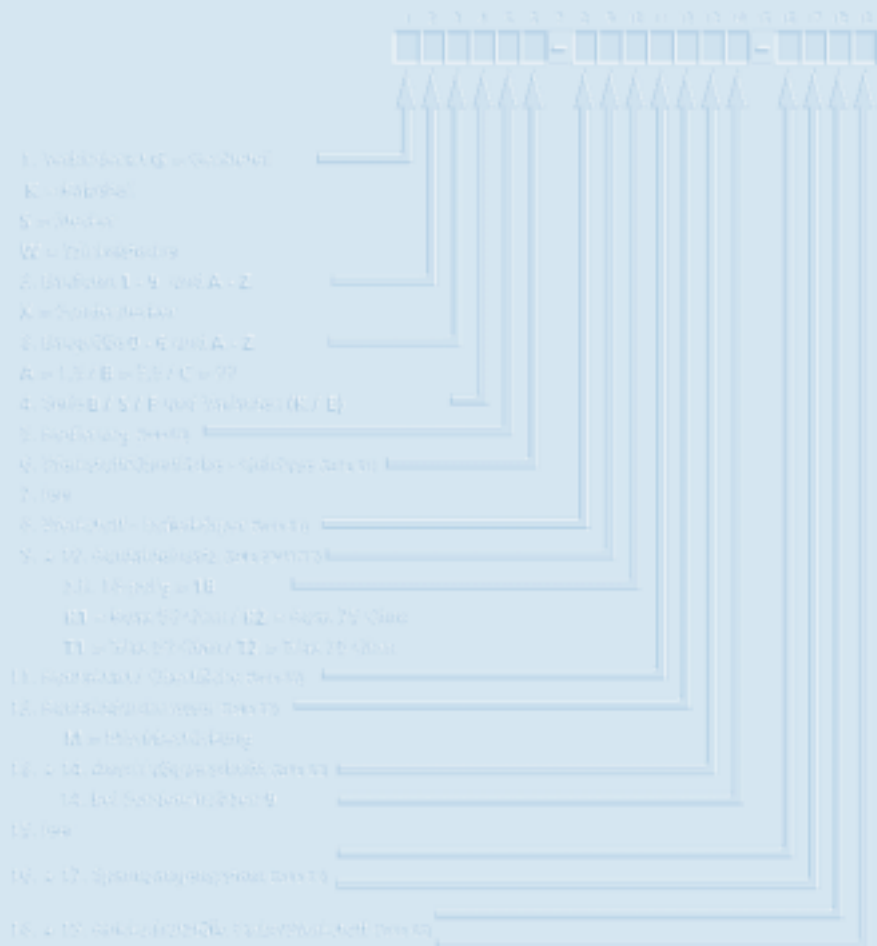

# Details for the Part Number Key:

- Housing Materials / Surfaces
- Insulation Body Material
- Contacts
- Contact Termination Cross Section (AWG)
- Collet System
- Bend Protection Sleeves





### Housing Materials / Surfaces

#### Part Number Key

1	2	3	4	5	6	7	8	9	10	11	12	13	14	15	16	17	18	19
			S	0		-								-				



- C** Standard  
Cu-alloy / matt chromate

---

- N** Special materials and surfaces on request.  
Cu-alloy / nickel

---

- S** Cu-alloy / black chromate

### Insulation Body Material

#### Part Number Key

1	2	3	4	5	6	7	8	9	10	11	12	13	14	15	16	17	18	19
			S	0		-								-				



- T** PBT

---

- P** PEEK

---

- Additional materials on request.

### Turned Contact

Article Number	PBT	PEEK
Solder Termination	✓	✓
Crimp Termination	✓	-
PCB Termination	✓	✓

✓ = available

### Contact Type / Contact Surface - Contact Diameter

#### Part Number Key

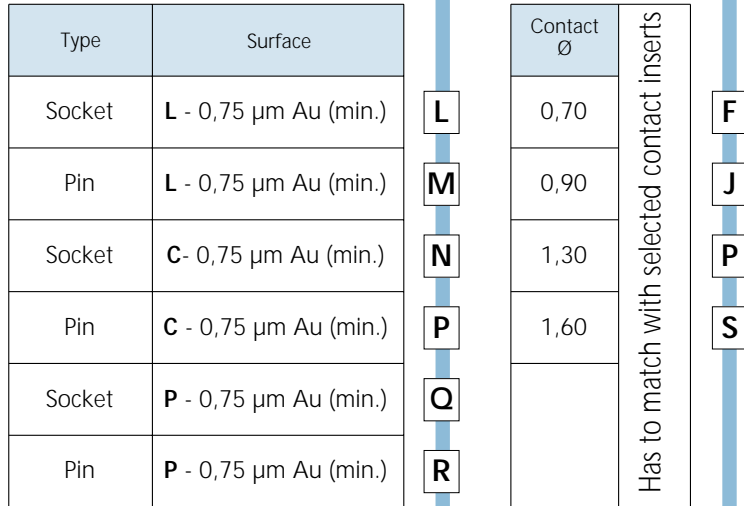
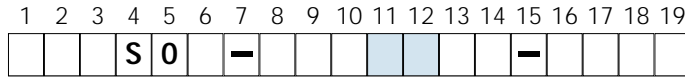

- L = Solder termination
- C = Crimp termination
- P = PCB termination

### Contact Termination Cross Sections

#### Part Number Key

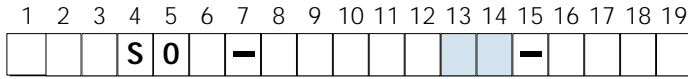

#### Crimp Contact

Contact Ø	Size	AWG	mm <sup>2</sup>
0,9	0	24/26	0,25/0,15
0,9	0	22	0,38
0,9	2	24/26	0,25/0,15
0,9	2	20/22	0,50/0,38
1,3	2	18	1,0



D	0
G	0
D	0
H	0
L	0

Tools for crimping and their adjustments see Page 166.

#### Solder Contact

Contact Ø	Term. Ø	Term. Cross	
		AWG	mm <sup>2</sup>
0,7	0,6	26	0,15
0,9	0,85	22	0,38
1,3	1,1	20	0,50
1,6	1,5	18	1,00

D	0
G	0
H	0
N	0

#### PCB Contact

Contact Ø	Term. Ø
0,9	0,7

0	0
---	---



## Collet System

### Part Number Key

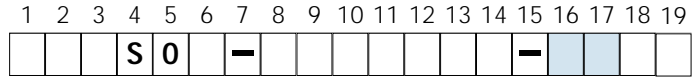
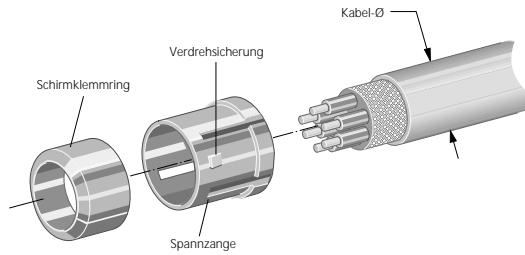

Insert: for all Plugs and In-Line Receptacles.

Application: **Collet nut** for strain relief,  
**EMI ring** for conductive path  
between shield and housing.

Cable diameter in mm	Size		
	0	1	2
> 2,0 - 2,5	●		
> 2,5 - 3,0	●	●	●
> 3,0 - 3,5	●	●	●
> 3,5 - 4,0	●	●	●
> 4,0 - 4,5	●	●	●
> 4,5 - 5,0	●	●	●
> 5,0 - 5,5		●	●
> 5,5 - 6,0		●	●
> 6,0 - 6,5		●	●
> 6,5 - 7,0		●	●
> 7,0 - 7,5			●
> 7,5 - 8,0			●
> 8,0 - 8,5			●
> 8,5 - 9,0			●
without collet system			

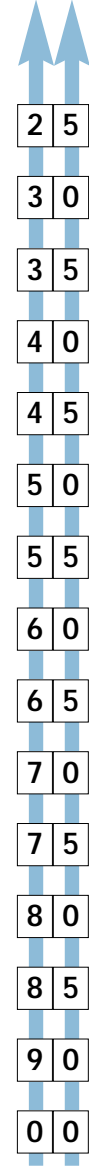



Cable Bend Relief

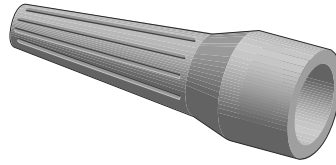

Part Number Key

1	2	3	4	5	6	7	8	9	10	11	12	13	14	15	16	17	18	19
			S	0		-								-				

Color of the Cable Bend Relief

Color / RAL-Number (similar)	
red	RAL 3020
white	RAL 9010
yellow	RAL 1016
green	RAL 6029
blue	RAL 5002
grey	RAL 7005
black	RAL 9005
orange	RAL 2004
purple	RAL 4005
brown	RAL 8016
light green	RAL 6018
light blue	RAL 5012
Material	
PUR	
without cable bend relief	



Temperature range  
 PUR -40 °C up to +80 °C  
 Short-term up to +120 °C