

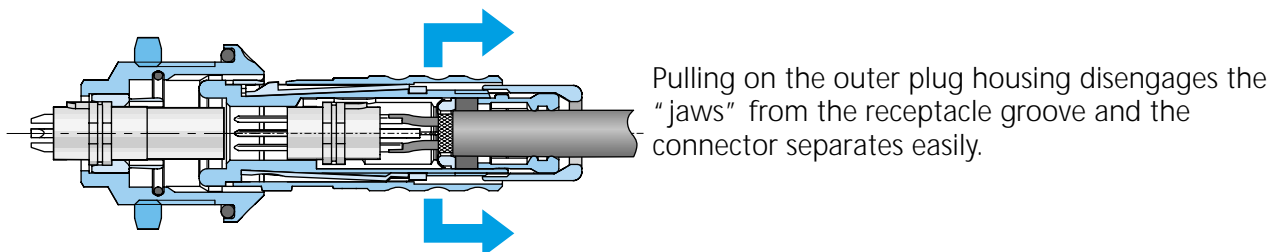

The Push-Pull Locking Principle: LP

with Jaws like LEMO® (see page 9)

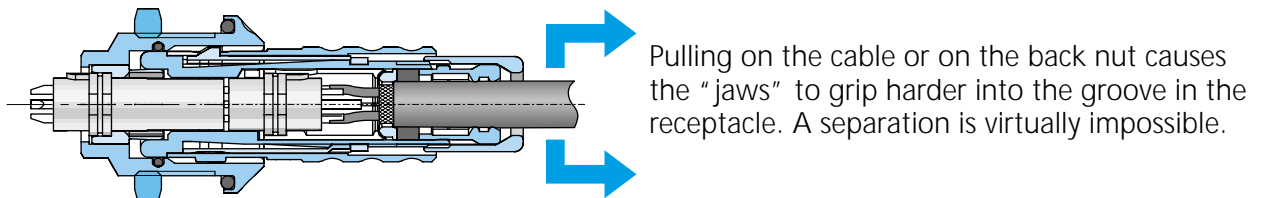
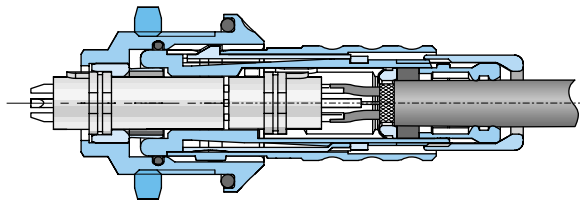
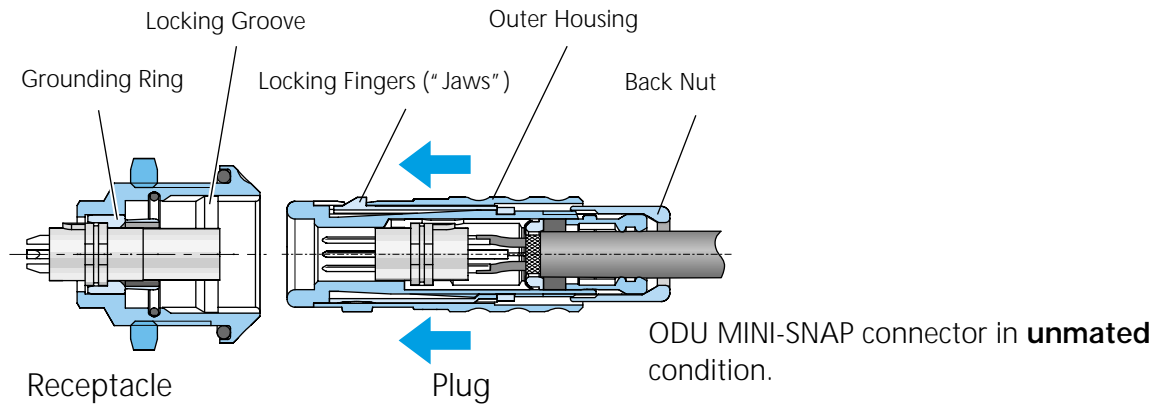

The Part number key

Part number key

1	2	3	4	5	6	7	8	9	10	11	12	13	14	15	16	17	18	19
			K			-									-			0

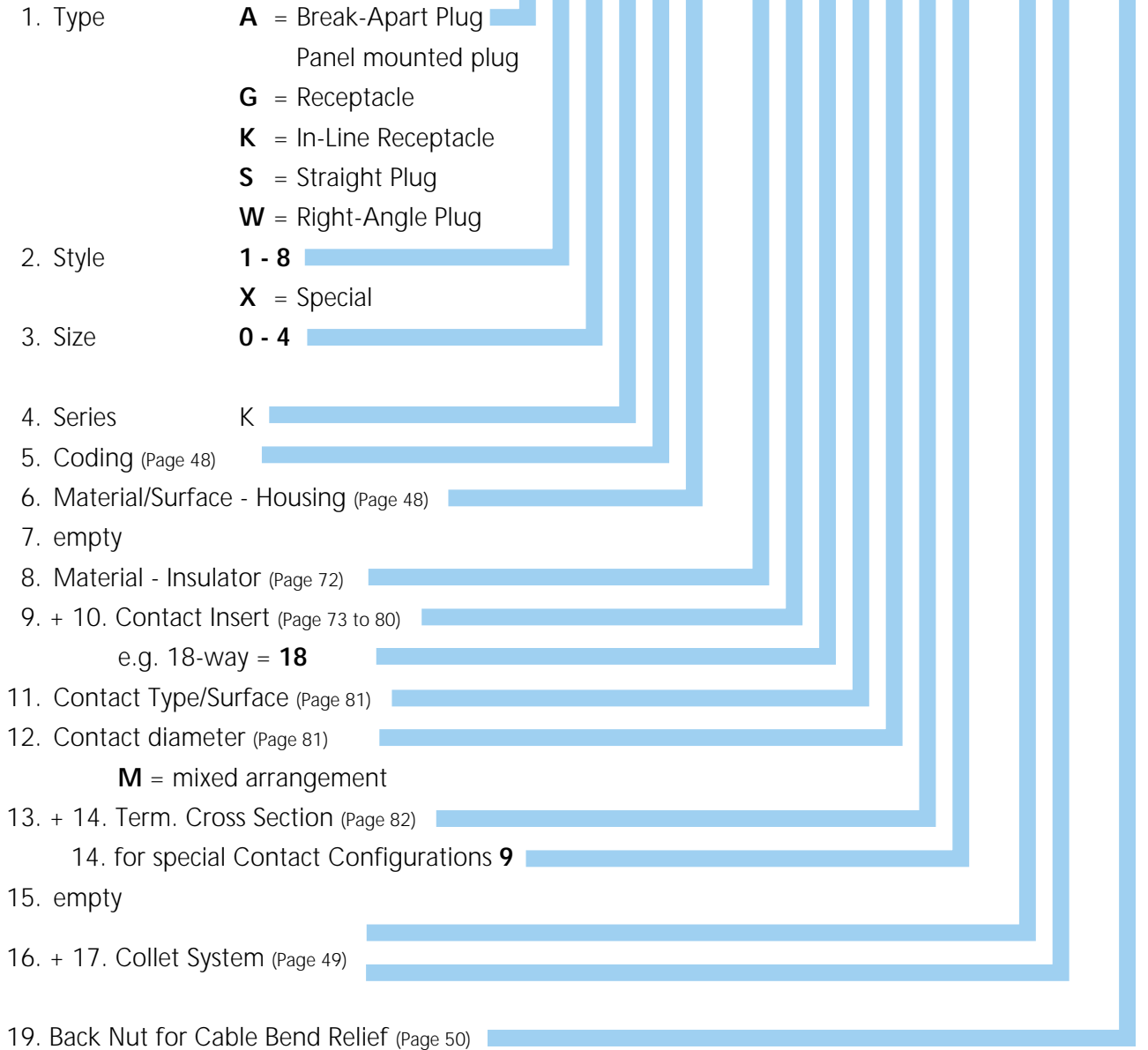

Example:

1	2	3	4	5	6	7	8	9	10	11	12	13	14	15	16	17	18	19
G	3	2	K	F	C	-	T	1	6	N	F	G	0	-	0	0	0	0

Receptacle - Style 3 - Size 2 - Series K - Coding 60° - Brass matt chromate Housing - PBT Insulator - 16pos. - Socket(crimp) 0,75 µm Au -Term. Cross Section AWG22

1	2	3	4	5	6	7	8	9	10	11	12	13	14	15	16	17	18	19
S	2	2	K	F	C	-	P	1	6	M	F	G	0	-	7	0	0	S

Plug - Style 2 - Size 2 - Series K - Coding 60° - Brass matt chromate Housing - PEEK Insulator - 16pos. - Pin (solder) 0,75 µm Au - Term. Cross Section AWG22 - Cable Diameter 6.0-7.2 mm -Back Nut for Silicone Cable Bend Relief (to order seperatly)

Part number key

1	2	3	4	5	6	7	8	9	10	11	12	13	14	15	16	17	18	19
			K			-								-				0

Straight Plug

(Suitable for all following receptacles and in-line receptacles)

- S 1** - IP 68 – with Standard Back Nut
- S 2** - IP 68 – with Back Nut for Cable Bend Relief*

S 1



Contact configuration from page 73

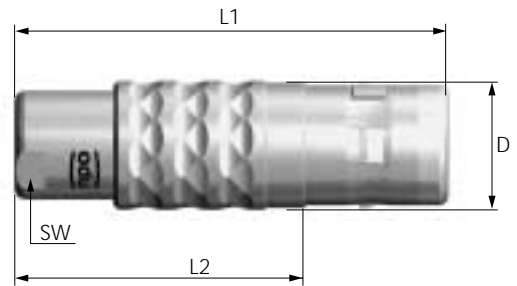

S 2

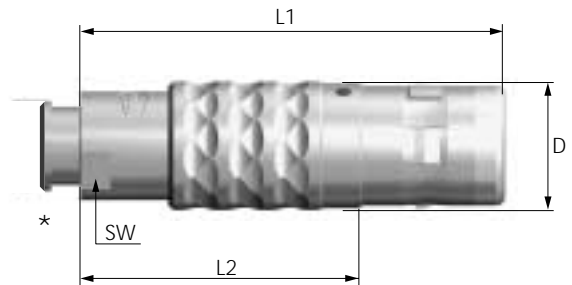

Size	Dimensions in mm			
	L1	L2	D	SW
0	~ 37	~ 25	11	7
1	~ 44	~ 27	13	10
2	~ 50	~ 33	16	12
3	~ 60	~ 40	19	14
4	~ 70	~ 49	25	20

* Cable Bend Reliefs have to be ordered separately.
(see page 100 - 101)

Part number key

1	2	3	4	5	6	7	8	9	10	11	12	13	14	15	16	17	18	19
			K			-								-				0



Break-Apart-Plug

- A 1** - IP 68 – with Standard Back Nut
- A 2** - IP 68 – with Back Nut for Cable Bend Relief*

A 1



Contact configuration from page 73

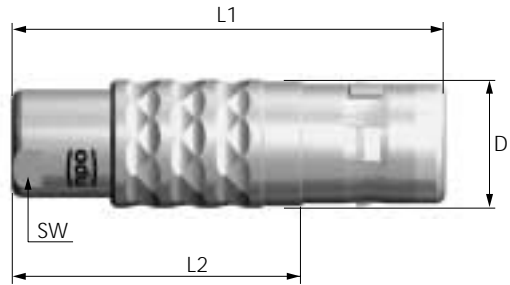

A 2

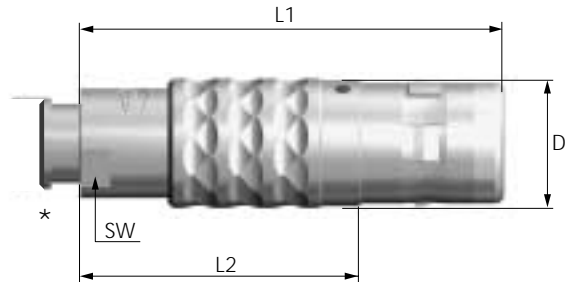

Connector can be separated by pulling the cable.

* **Cable Bend Reliefs have to be ordered separately.**
(see page 100 - 101)

Size	Dimensions in mm			
	L1	L2	D	SW
0	~ 37	~ 25	11	7
1	~ 44	~ 35	13	10

Panel-Mounted Plug

- A A** - IP 68 – with hex nut, non-latching, installation from front of panel

A A

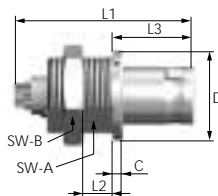

Technical Data

- IP 68 in mated condition
- anti-rotation feature
- contact configuration and PCB-Layout from page 73

Size	Dimensions in mm									Panel cut-out
	L max.	L1	L2	L3	M	D	SW-A	SW-B		
1	28	23,5	4	16,3	16x1,0	19,9	14,5	18,5	SW 14,6 / Ø 16,1	
2	32	28	4,5	19	20x1,0	24,9	18,5	25	SW 18,6 / Ø 20,1	

Created to build up a docking connection between 2 instruments (E.g. a charging station).

Collet System

Part number key

1	2	3	4	5	6	7	8	9	10	11	12	13	14	15	16	17	18	19
			K			-								-				0

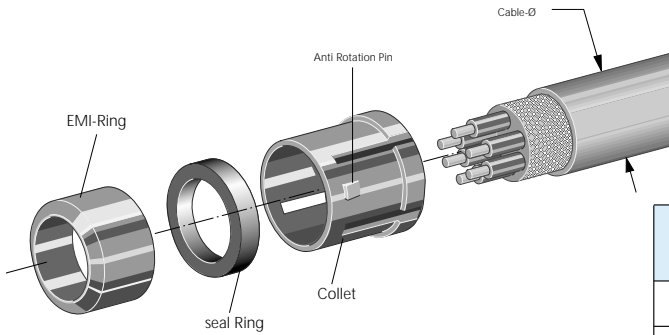

Useable: for all Plugs and In-Line Receptacles.

Application: **Collet nut** for strain relief.

Cable diameter in mm	Size				
	0	1	2	3	4
> 1,5 - 2,0	●	●			
> 2,0 - 2,5	●	●			
> 2,5 - 3,0	●	●	●		
> 3,0 - 3,5	●	●	●	●	
> 3,5 - 4,0	●	●	●	●	
> 4,0 - 4,5	●	●	●	●	
> 4,5 - 5,0	●	●	●	●	
> 5,0 - 5,5		●	●	●	
> 5,5 - 6,0		●	●	●	
> 6,0 - 6,5		●	●	●	
> 6,5 - 7,0		●	●	●	
> 7,0 - 7,5			●	●	
> 7,5 - 8,0			●	●	
> 8,0 - 8,5			●	●	
> 8,5 - 9,0			●	●	
> 9,0 - 9,5				●	
> 9,5 - 10,0				●	
> 10,0 - 10,5				●	
> 13,5 - 14,0					●
without cable collet					

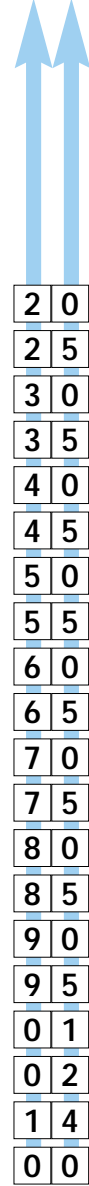



Insulation Body Material

Part number key

1	2	3	4	5	6	7	8	9	10	11	12	13	14	15	16	17	18	19
						-								-			0	



T

PBT

P

PEEK

Additional materials on request

Turned Contacts

Article Number	PBT	PEEK
Solder Termination	✓	✓
Crimp Termination	✓	✓*
PCB Termination	✓	✓

✓ = available

* = PEEK insulators have crimp contacts with clip