

EMULATOR ADAPTERS - DEVICE-SPECIFIC - SOCKETABLE

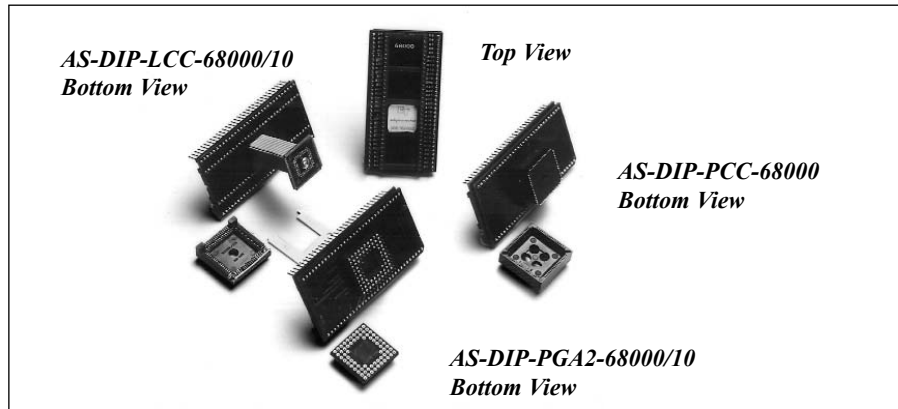

HOW TO ORDER

Identify the following characteristics to determine the Emulation Technology part number.

- 1) The manufacturer and IC to be emulated (i.e. Motorola 68000/10).
- 2) Package type of the emulator pod.
- 3) Package type of the target socket.
- 4) Verify top and bottom footprints (see Footprint Section).

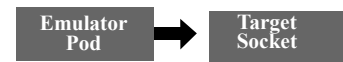

Icons identify your emulator pod and target socket.

Ordering Information Example

Product Code _____ AS-PGA-QF03T-68302 _____ IC to be Emulated
 Emulator Pod Female Receptacle _____ Footprint Target Socket

T = For Textool Socket
 Y = For Yamaichi Socket

For a complete listing of emulator adapters pricing and delivery information, see:
 Web Link: www.1800adapter.com/093

Motorola	Motorola	AMD
<p>DIP → PGA</p> <p>Description # Document # AS-DIP-PGA2-68000/10 F2230 AS-DIP-PGA2-68000/10LN F2432 LN = Low Noise Version with ground plane and no test points. (PGA2 = 10 X 10)</p> <p>DIP → PLCC</p> <p>Description # Document # AS-DIP-PCC-68000/10 F1234 AS-DIP68K-PCC-68EC000 F1155 AS-DIP-PCC-68HC11 F1982 AS-DIP-PCC-68008 F2290 (Note: Used with 48 pin or 52 pin emulator pod) AS-DIP-PCC-6809 F2289</p> <p>PGA → DIP</p> <p>Description # Document # AS-PGA2-DIP-68000/10 F2474 AS-PGA2-DIP-68000/10LN F1805 LN = Low Noise Version with ground plane and no test points.</p>	<p>PLCC → QFP</p> <p>Description # Document # AS-PCC5-QF14Y-68HC11K4 F1969</p> <p>PLCC → DIP</p> <p>Description # Document # AS-PCC-DIP-68000/10 F2465 AS-PCC-DIP-68HC11 F1385 AS-PCC-DIP-68008 F2229 (Note: Used with 48 pin or 52 pin DIP target board)</p> <p>PLCC → PGA</p> <p>Description # Document # AS-PCC-PGA2-68000/10 F2070 AS-PCC1S-PGA2-MC68440 F1687</p> <p>PLCC → PLCC</p> <p>Description # Document # AS-PCC68K-PCC-68EC000 F1097 AS-PC68EC-PCC1-68HC000/68000 F2470</p>	<p>PGA → PQFP</p> <p>Description # Document # AS-PGA8-QF03T-386DXL F1400</p>
		<p>Microchip</p> <p>DIP → PLCC</p> <p>Description # Document # AS-DIP-PCC-PC16C74/64/65 F3939 AS-DIP-PCC-PC17C42/43/44 F3970</p>
		<p>Wired 1 to 1</p> <p>PLCC → QFP</p> <p>Description # Document # AS-PCC3-QF16S-GEN F1377 AS-PCC3-QF16DS-GEN F3949 AS-PCC5-QF02S-GEN F4327</p> <p>QFP → QFP</p> <p>Description # Document # AS-QF08S-QF08S-GEN F4498 AS-QF09S-QF09S-GEN F5004 AS-QF10S-QF63Y-GEN F5078</p>
	<p>Hitachi</p> <p>SHRINK DIP → PLCC</p> <p>Description # Document # AS-SDIP-PCC-64180 F1023 AS-SDIP-PCC-6301/701 F1024</p> <p>PLCC → SHRINK DIP</p> <p>Description # Document # AS-PCC-SDIP-64180 F2467</p> <p>PLCC → QFP</p> <p>Description # Document # AS-PCC5-QF47Y-H8534 F4559</p> <p>PGA → SHRINK DIP</p> <p>Description # Document # AS-PGA-SDIP-64180 F2472</p>	
	<p>Intel</p> <p>PLCC → PLCC</p> <p>Description # Document # AS-PCC1-PCC4-N80C196KB/198 F1278 AS-PCC1-PCC5-80186EB F1298</p> <p>PGA → LCC</p> <p>Description # Document # AP3-68-PGA F2374 (Used with Intel 80186/80286)</p>	
<p>Zilog</p> <p>DIP → PLCC</p> <p>Description # Document # AS-DIP-PCC-Z80 F2058 AS-DIP-PCC-Z86C21 F4547</p>		<p>Intel</p> <p>LCC → PLCC</p> <p>Description # Document # AP4-68-LCC F1077 (Used with Intel 80186/80286)</p> <p>PGA → PLCC</p> <p>Description # Document # AP4-68-PGA F1124 (Used with Intel 80186/80286) AP4-68-PGA1-FLIP* F1838 (Used with Intel MCS96)</p> <p>PLCC → DIP</p> <p>Description # Document # AS-PCC-DIP-8031/51 F1137</p>

DEVICE-SPECIFIC - SURFACE MOUNTABLE - EMULATOR ADAPTERS

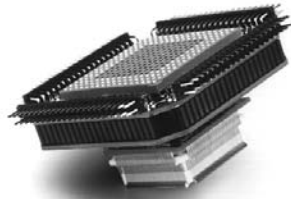

AS-PGA-QF03S-68302

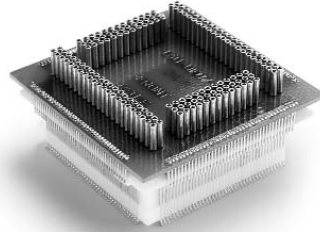

EPP-160-QF07-SM

Ordering Information Example

Product Code _____ AS-PGA-QF29*S-68020 _____ IC to be Emulated
 Emulator Pod Female Receptacle _____ Footprint Type (See Footprint Section)
 _____ Surface Mount Pad Footprint

Emulator Pod

Target Socket

Icons identify your emulator pod and target socket.

HOW TO ORDER

Determine the following characteristics to identify the ET part number.

- 1) Chip manufacturer for the IC to be emulated. (i.e. Motorola 68000/10).
- 2) Package type of the emulator pod.
- 3) Package type of the target socket.
- 4) Verify top and bottom footprints (see package coding system).

HOW TO ORDER

REPLACEMENT BASES

- 1) Find the QFXXX in your original part number (i.e. your PQFP package footprint number).
- 2) Turn to the package coding system to locate complete ordering information.

EMULATOR TOOLS & ADAPTERS

Analog Devices	Motorola	Intel
<p>PGA → PQFP SMT Pads</p> <p>Description # Document # AS-PGA-QF01S-ADSP2111 F3389 AS-PGA1-QF14S-ADSP2101 F1572</p>	<p>PLCC → PQFP SMT Pads</p> <p>Description # Document # AS-PCC1-QF14S-68HC11F1 F3960 AS-PCC1-QF14DS-68HC11F1 F1424 AS-PCC1-QF14DS-68HC11KA4 F4158 AS-PCC1-QF29S-68EC000 F2111 AS-PCC1-QF29S-68HC11KA4/KA2 F4001 AS-PCC4-QF29S-68HC05B6 F4555 AS-PCC4-QF29S-68HC11/711E9/A8 F1922 AS-PCC4-QF29DS-68HC11/711E9/A8F4277 F4555 AS-PCC5-QF14S-68HC11K4 F1064</p>	<p>PLCC → PQFP SMT Pads</p> <p>AS-PCC1-QF08S-80186/88(XL) F1172 AS-PCC1-QF08S-80186/88EA F1870 AS-PCC1-QF08S-80/83C196KB/KC/KD F1733 AS-PCC1-QF34S-87C196KM F4556 AS-PCC1-QF47S-80186/88(XL)(EA) F1937 AS-PCC5-QF08S-80186B/88 F1671 AS-PCC5-QF47S-80186/88EB F2275</p>
<p>Hitachi</p> <p>PLCC → PQFP SMT Pads</p> <p>Description # Document # AS-PCC5-QF14S-H8532/34/36 F1018 AS-PCC5-QF14S-H8330/37 F1140 AS-PCC5-QF47S-H8534 F3880</p>	<p>PGA → PQFP SMT Pads</p> <p>AS-PGA-QF03S-56001 F1034 AS-PGA-QF03S-68020 F1035 AS-PGA-QF03S-68030 F1036 AS-PGA-QF03S-68302 F1854 AS-PGA-QF03S-68332 F2099</p>	<p>PGA → PQFP SMT Pads</p> <p>AS-INTELICE-QF06S-80C186EC F4288 AS-PGA8-QF03S-80386DXL-NTP F2256 AS-PGA8-QF03S-80960JX F3887 AS-PGA8-QF03S-80960KA/KB F1434 AS-PGA8-QF03SLP-80960KA/KB F4548 AS-PGA10-QF15S-486SX/DX F2473 AS-PGA10-QF67S-486GX F4197 AS-PGA10-QF67S-486SX F4072 AS-PGA10-QF15S-80960CA/CF F1191 AS-PGA10-QF21S-486SX/DX F2021 AS-PGA10-QF21S-80960HX F4328</p>
<p>DIP → PQFP SMT Pads</p> <p>AS-DIP1-QF09S-63X03RF F2228</p>	<p>PQFP SMT Pads</p> <p>AS-PGA1-QF14DS-68HC11F1 F4552 AS-PGA3-QF14S-68HC11K4 F2476 AS-PGA3-QF14S-68HC12 F5049 AS-PGA3-QF49S-68LC302 F3853 AS-PGA3/68302-QF49S-68LC302 F3937</p>	<p>DIP → PQFP SMT Pads</p> <p>AS-DIP-QF16DS-8031/51 F5184 AS-DIP-QF16S-8031/51 F1051</p>
<p>SDIP → PQFP SMT Pads</p> <p>AS-SDIP-QF29S-H8/320 F2097 AS-SDIP1-QF09S-63X03Y F2094 Note: No Test Points</p>	<p>PGA → PQFP SMT Pads</p> <p>AS-PGA3-QF63S-68302 F2257 AS-PGA4-QF10S-68340 F1394 AS-PGA4-QF63S-68EN302 F4326 AS-PGA4-QF63S-68PM302 F4165 AS-PGA4-QF63S-68331 F4308 AS-PGA4-QF63S-68340 F2080 AS-PGA8-QF07S-68336-TP F4305 AS-PGA11-QF31S-68EC040/LC040 F2133 AS-PGA11-QF62S-68060-HIS F4262 AS-PGA11-QF62S-68360/EN360 F1940 AS-PGA11-QF62S-68360/EN360-HIS F3882 AS-100P3-QF06S-68EC020-NTP F2422 AS-114P3-QF06S-68EC020-NTP F1468</p>	<p>PGA → PQFP SMT Pads</p> <p>AS-PGA8-QF05S-V53 F1251</p>
<p>Zilog</p> <p>DIP → PQFP SMT Pads</p> <p>Description # Document # AS-DIP1-QF16S-Z80 F4285 AS-DIP1-QF16S-Z86 F5312</p>	<p>PLCC → PQFP SMT Pads</p> <p>AS-PCC1-QF08S-Z180 F4549</p>	<p>PGA → QFP</p> <p>AS-PGA-QF63DS-68302 F5475 AS-PGA3-QF63S-68302-NTP F5480</p>
<p>NEC</p> <p>PGA → PQFP SMT Pads</p> <p>Description # Document # AS-PGA8-QF05S-V53 F1251</p>	<p>PQFP SMT Pads</p> <p>AS-QF03A-QF63S-68332-0 F2482 AS-QF03T-QF63S-68HC16Z1 F4086</p>	<p>DIP → PQFP SMT Pads</p> <p>AS-DIP-QF16S-68HC05/705C8FB F1214 AS-DIP-QF16S-4044G F5614</p>
<p>PLCC → PQFP SMT Pads</p> <p>AS-PCC5-QF32S-V25 F1843 AS-PCC1-QF08S-V40 F1852</p>	<p>DIP → PQFP SMT Pads</p> <p>AS-SDIP-QF29S-68HC05F6FU F4286</p>	<p>SDIP → PQFP SMT Pads</p> <p>AS-SDIP-QF29S-68HC05F6FU F4286</p>

For a complete listing of emulator adapters and additional information, see:

Web Link: www.1800adapter.com/093

EMULATOR ADAPTERS - WIRED 1-TO-1 - SOCKETABLE - PLCC, LCC, PGA

EMULATOR TOOLS & ADAPTERS

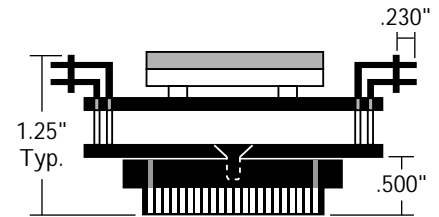
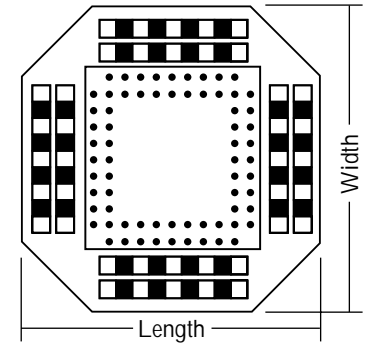
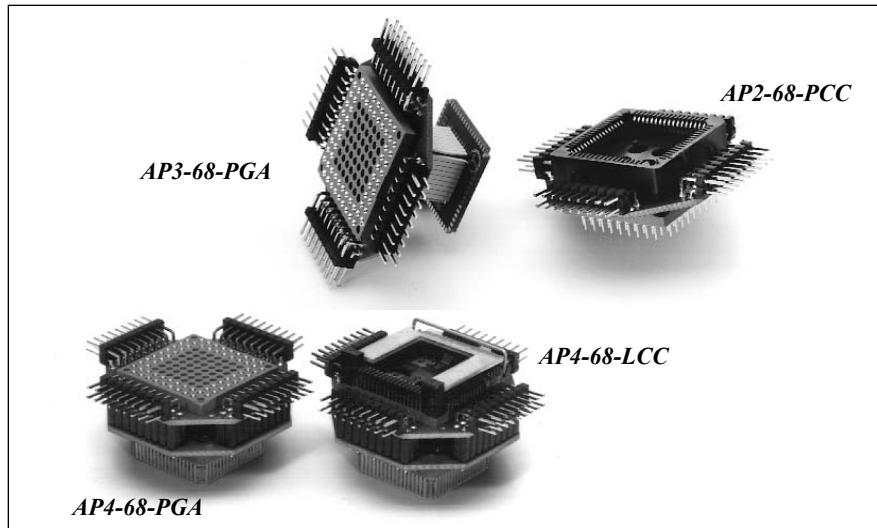

Note: Drawing applies to pods with PLCC target socket.

Ordering Information Example

Product Code _____ AP 4-68-PGA-ST-(FLIP*)

Male Plug: 1=DIP, 2=PGA, 3=LCC, 4=PLCC

Target Socket and Emulator Pod Pin Count _____ Female Emulation Pod Receptacle

ST = Straight Test Points
 NT = No Test Points
 MM = Male to Male Plug
 LP = Low Profile

Emulator Pod → **Target Socket** Icons identify your emulator pod and target socket.

PGA	PLCC
Description #	Document #
AP4-28-PGA	F2383
AP4-32-PGA	F2385
AP4-44-PGA	F2388
AP4-52-PGA	F1049
AP4-68-PGA	F1124
AP4-68-PGA-LP	F4256
AP4-68-PGA-NT	F1382
AP4-68-PGA-ST	F2391
AP4-68-PGA1-FLIP* (NT)	F2392
AP4-84-PGA	F1697
AP4-84-PGA-NT	F1765
AP4-84-PGA-ST	F2394

PGA	LCC
AP3-68-PGA	F2374

PLCC	PLCC
Description #	Document #
AP4-20-PCC-ST	F2380
AP4-28-PCC	F2382
AP4-28-PCC-ST	F1899
AP4-32-PCC	F2384
AP4-44-PCC	F1780
AP4-44-PCC-MM	F4532
AP4-44-PCC-ST	F1779
AP4-52-PCC-MM	F1925
AP4-52-PCC-NT	F1445
AP4-52-PCC	F2034
AP4-68-PCC	F1443
AP4-68-PCC-MM	F2389
AP4-68-PCC-NT	F2390
AP4-68-PCC-ST	F2235
AP4-84-PCC	F1091
AP4-84-PCC-MM	F1797
AP4-84-PCC-ST	F2234

PLCC	PGA
Description #	Document #
AP2-44-PCC	F1732
AP2-68-PCC	F1518
AP2-68-PCC1-FLIP*	F2362
AP2-84-PCC	F2076

PLCC	LCC
AP3-68-PCC	F2372

LCC	PLCC
Description #	Document #
AP4-32-LCC	F1958
AP4-68-LCC	F1077
AP4-84-LCC5C	F2028

(For JEDEC Type C)

- ### HOW TO ORDER
- 1) Find your emulator pod and target socket package type combination in the table on this page. (i.e. emulator pod: PGA; target socket: PLCC).
 - 2) Locate the part number with the correct number of pins for the emulator pod and target socket (i.e. AP4-20-PGA is the right part for 20-pin emulator pods and target sockets).
 - 3) All parts are wired 1-to-1, top to bottom, except flip adapters. On flip adapters, signals names change direction from clockwise to counterclockwise, top to bottom.

For a complete listing of emulator adapters pricing and delivery information, see:
 Web Link: www.1800adapter.com/093

WIRED 1-TO-1 - SURFACE MOUNTABLE - PLCC, POFP/TOFP - EMULATOR ADAPTERS

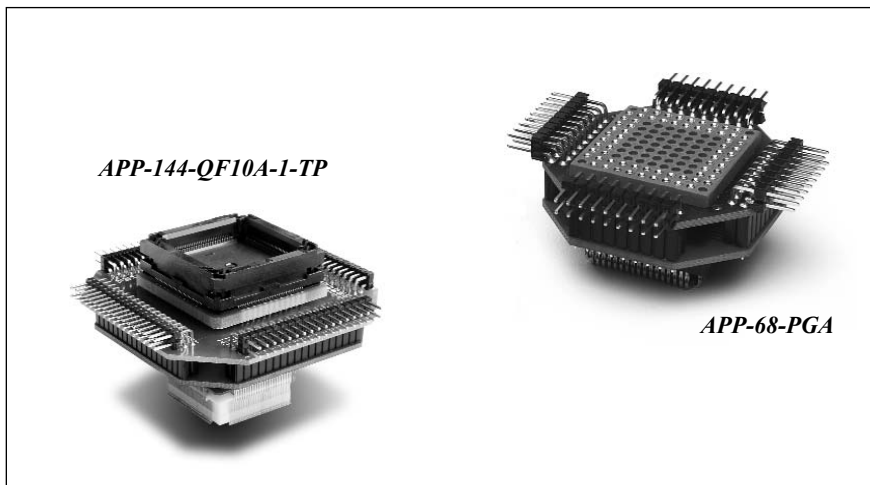

HOW TO ORDER

- 1) Find your emulator pod and target socket package type combination in the table on this page. (i.e. emulator pods: PGA; target socket: SMT).
- 2) Locate the part number with the correct number of pins for the emulator pod and target socket (i.e. APP-44-PGA is the right part for 44-pin emulator pods and target sockets).
- 3) All parts are wired 1-to-1, top to bottom.

Ordering Information Example

Product Code _____ (NTP) = No Test Points
 (TP) = with Test Points
 Target SMT Pads _____ AP P-100-QF01A-(0)-(NTP)
 Pin Count _____ 0 = w/out Production Socket
 1 = with Production Socket
 2 = with Burn-in Socket
 Emulation Pod Receptacle Footprint _____ A=AMP, T=TEXTTOOL, Z=ZIF

Emulator Pod

Target Socket

Icons identify your emulator pod and target socket.

<p>PLCC → PLCC SMT Pads</p> <table border="1"> <thead> <tr> <th>Description #</th> <th>Document #</th> </tr> </thead> <tbody> <tr><td>APP-32-PCC</td><td>F2416</td></tr> <tr><td>APP-44-PCC</td><td>F2253</td></tr> <tr><td>APP-52-PCC</td><td>F1454</td></tr> <tr><td>APP-68-PCC</td><td>F2419</td></tr> <tr><td>APP-84-PCC</td><td>F2077</td></tr> </tbody> </table> <p>Note: Bottom pins emulate the PLCC package.</p>	Description #	Document #	APP-32-PCC	F2416	APP-44-PCC	F2253	APP-52-PCC	F1454	APP-68-PCC	F2419	APP-84-PCC	F2077	<p>PGA Production Socket → PLCC SMT Pads</p> <table border="1"> <thead> <tr> <th>Description #</th> <th>Document #</th> </tr> </thead> <tbody> <tr><td>APP-44-PGA</td><td>F1658</td></tr> <tr><td>APP-68-PGA</td><td>F1403</td></tr> <tr><td>APP-84-PGA</td><td>F2224</td></tr> </tbody> </table> <p>Note: Bottom pins emulate the PLCC package.</p>	Description #	Document #	APP-44-PGA	F1658	APP-68-PGA	F1403	APP-84-PGA	F2224
Description #	Document #																				
APP-32-PCC	F2416																				
APP-44-PCC	F2253																				
APP-52-PCC	F1454																				
APP-68-PCC	F2419																				
APP-84-PCC	F2077																				
Description #	Document #																				
APP-44-PGA	F1658																				
APP-68-PGA	F1403																				
APP-84-PGA	F2224																				
<p>PQFP Production Socket Footprint → QFP SMT Pads</p> <table border="1"> <thead> <tr> <th>Description #</th> <th>Document #</th> </tr> </thead> <tbody> <tr><td>APP-132-QF03A-0-NTP</td><td>F2411</td></tr> <tr><td>APP-132-QF03T-0-TP</td><td>F2412</td></tr> <tr><td>APP-144-QF10A-0-TP</td><td>F1604</td></tr> </tbody> </table>	Description #	Document #	APP-132-QF03A-0-NTP	F2411	APP-132-QF03T-0-TP	F2412	APP-144-QF10A-0-TP	F1604	<p>PQFP Production Socket → QFP SMT Pads</p> <table border="1"> <thead> <tr> <th>Description #</th> <th>Document #</th> </tr> </thead> <tbody> <tr><td>APP-100-QF01T-1-NTP (Used with Sophia emulator)</td><td>F2410</td></tr> <tr><td>APP-100-QF01A-1-TP</td><td>F4537</td></tr> <tr><td>APP-132-QF03A-1-TP</td><td>F1175</td></tr> <tr><td>APP-132-QF03T-1-TP</td><td>F2413</td></tr> <tr><td>APP-144-QF10A-1-TP</td><td>F1678</td></tr> </tbody> </table>	Description #	Document #	APP-100-QF01T-1-NTP (Used with Sophia emulator)	F2410	APP-100-QF01A-1-TP	F4537	APP-132-QF03A-1-TP	F1175	APP-132-QF03T-1-TP	F2413	APP-144-QF10A-1-TP	F1678
Description #	Document #																				
APP-132-QF03A-0-NTP	F2411																				
APP-132-QF03T-0-TP	F2412																				
APP-144-QF10A-0-TP	F1604																				
Description #	Document #																				
APP-100-QF01T-1-NTP (Used with Sophia emulator)	F2410																				
APP-100-QF01A-1-TP	F4537																				
APP-132-QF03A-1-TP	F1175																				
APP-132-QF03T-1-TP	F2413																				
APP-144-QF10A-1-TP	F1678																				
<p>PQFP ZIF Socket → QFP SMT Pads</p> <table border="1"> <thead> <tr> <th>Description #</th> <th>Document #</th> </tr> </thead> <tbody> <tr><td>APP-100-QF49Z-NTP</td><td>F4451</td></tr> </tbody> </table>	Description #	Document #	APP-100-QF49Z-NTP	F4451																	
Description #	Document #																				
APP-100-QF49Z-NTP	F4451																				
<p>TSOP ZIF Socket → QFP SMT Pads</p> <table border="1"> <thead> <tr> <th>Description #</th> <th>Document #</th> </tr> </thead> <tbody> <tr><td>APP-032-TS01Z-2</td><td>F5069</td></tr> <tr><td>APP-048-TS01Z-WELS</td><td>F4536</td></tr> </tbody> </table>	Description #	Document #	APP-032-TS01Z-2	F5069	APP-048-TS01Z-WELS	F4536															
Description #	Document #																				
APP-032-TS01Z-2	F5069																				
APP-048-TS01Z-WELS	F4536																				

For a complete listing of emulator adapters pricing and delivery information, see:
 Web Link: www.1800adapter.com/093

EMULATOR ADAPTERS - SURFACE MOUNTABLE - DIP TO SMT

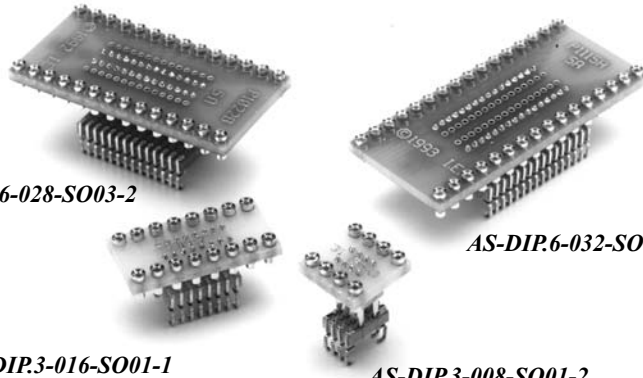

AS-DIP.6-028-SO03-2

AS-DIP.6-032-SO10-1

AS-DIP.3-016-SO01-1

AS-DIP.3-008-SO01-2

Ordering Information Example

Product Code _____ AS-DIP.6-040-SO11-1(2) _____ | 1 = 1 piece SOIC
 Female Top Socket _____ | 2 = 2 piece SOIC
 Dip Width _____ | Footprint Code (See Footprint Section)
 Pin Count (Top & Bottom) _____

FEMALE DIP → SOIC, TSSOP, SSOP SMT

Pin Count	DIP Width (inches)	Bottom SMT Lead Pitch (mm)	Bottom SMT Body Width (mm)	ET PART #	Drawing#
6	0.300	1.27	0.155	AS-DIP.3-006-SO01-2	F5014
8	0.300	1.27	0.155	AS-DIP.3-008-SO01-1	F2435
8	0.300	1.27	0.155	AS-DIP.3-008-SO01-2	F2434
14	0.300	1.27	0.155	AS-DIP.3-014-SO01-2	F2436
16	0.300	1.27	0.155	AS-DIP.3-016-SO01-1	F2438
16	0.300	1.27	0.155	AS-DIP.3-016-SO01-2	F5014
16	0.300	1.27	0.300	AS-DIP.3-016-SO03-1	F2110
16	0.300	1.27	0.300	AS-DIP.3-016-SO03-2	F5014
16	0.300	0.65	0.173	AS-DIP.3-016-ST03-1	F6651
18	0.300	1.27	0.155	AS-DIP.3-018-SO01-2	F5014
18	0.300	1.27	0.300	AS-DIP.3-018-SO03-2	F1219
20	0.300	1.27	0.155	AS-DIP.3-020-SO01-1	F5014
20	0.300	1.27	0.155	AS-DIP.3-020-SO01-2	F2442
20	0.300	1.27	0.208	AS-DIP.3-020-SO02-2	F5843
20	0.300	1.27	0.300	AS-DIP.3-020-SO03-1	F2252
20	0.300	1.27	0.300	AS-DIP.3-020-SO03-2	F2443
20	0.300	0.65	0.173	AS-DIP.3-020-ST03-1	F6345
20	0.600	1.27	0.300	AS-DIP.6-020-SO03-1	F5014
20	0.600	1.27	0.300	AS-DIP.6-020-SO03-2	F5014
24	0.300	1.27	0.300	AS-DIP.3-024-SO03-1	F2449
24	0.300	1.27	0.300	AS-DIP.3-024-SO03-2	F5014
24	0.300	0.65	0.173	AS-DIP.3-024-ST03-1	F7194
24	0.600	1.27	0.300	AS-DIP.6-024-SO03-1	F2451
24	0.600	1.27	0.300	AS-DIP.6-024-SO03-2	F2452
24	0.600	1.27	0.421	AS-DIP.6-024-SO08-1	F5014
24	0.600	1.27	0.421	AS-DIP.6-024-SO08-2	F2447
28	0.600	1.27	0.300	AS-DIP.6-028-SO03-1	F1408
28	0.600	1.27	0.300	AS-DIP.6-028-SO03-2	F2249
28	0.600	1.27	0.300	AS-DIP.6-028-SO03-OFFSET	F7195
28	0.300	1.27	0.300	AS-DIP.3/6-SOIC.3S-GENERICZ	F1960
28	0.600	1.27	0.421	AS-DIP.6-028-SO08-1	F1176
28	0.600	1.27	0.421	AS-DIP28.6Z-028-SO08-1	F3306
28	0.600	0.65	0.209	AS-DIP.6-028-SS34-1	F5527
28	0.400	1.27	0.350	AS-SDP.4-028-SO05-2	F2086
28	0.300	1.27	0.300	AS-DIP.3-028-ST03-1	F2086
32	0.600	1.27	0.300	AS-DIP.6-032-SO03-1	F2458
32	0.600	1.27	0.300	AS-DIP.6-032-SO03-2	F5014
32	0.600	1.27	0.421	AS-DIP.6-032-SO08-1	F5777
32	0.600	1.27	0.449	AS-DIP.6-032-SO10-1	F2456
32	0.600	1.27	0.449	AS-DIP.6-032-SO10-2	F2455
40	0.600	1.02	0.300	AS-40DIP.6-40SO12-VSOP	F7196

For a complete listing of emulator adapters pricing and delivery information, see:

Web Link: www.1800adapter.com/093

DIP TO TSSOP, SOP, & SOIC SMT PACKAGE CONVERTERS

These adapters enable you to adapt 6 to 32-pin DIPs to SOIC-type footprints. These devices have a two-piece construction: a top DIP assembly with interconnects to a SOIC surface-mountable assembly that is soldered to the target PC board and then, the top assembly is plugged onto it.

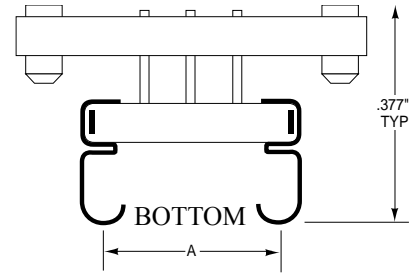

SOIC Lead Pitch = 0.05"

FEATURES

- Adapters can be used for prototyping SMT boards with DIP devices
- Provide interconnects to SMT patterns for testing
- Constructed with gold-plated machined pin contacts for high reliability
- Add a programming adapter with machining screw pins and turn your surface mount pins to a ZIF socket

HOW TO ORDER

- 1) Locate the part number with the correct number of pins for the emulator pod and target socket.
- 2) All parts are wired 1-to-1, top to bottom.

Try our New Soldering Iron Systems

Temperature controlled, compact soldering systems with additional tips. (ESTD-SAFE version also)

Web Link: www.1800adapter.com/150

Try our Chip Quik® SMD Removal Kit

Speeds up SMD removal without requiring expensive equipment or risking the use of heat guns.

Web Link: www.1800adapter.com/046

DIP TO TSOP & MLF - SURFACE MOUNTABLE - EMULATOR ADAPTERS

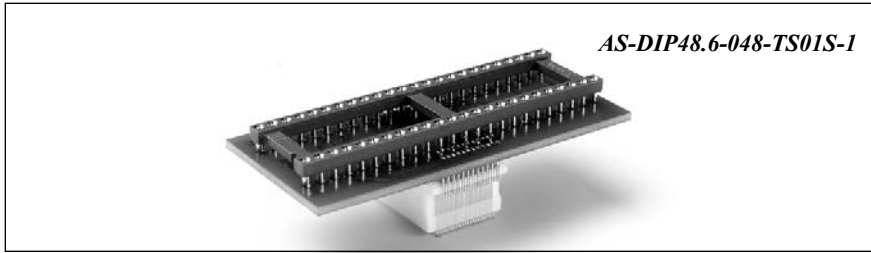

Ordering Information

Female Top Socket _____ Dip Width (.600")
 Product Code _____ AS-DIP48.6-048-TS01S-1 _____ | 1 = 1 piece
 Pin Count (Top) _____ Footprint Code (See Footprint Section)
 Pin Count (Bottom) _____

FEMALE DIP →

QFN/MLF TSOP SMT

Pin Count	TOP Socket Package Width (Inches)	Bottom Package Code Lead Pitch (mm)	Bottom SMT Package Code	Bottom SMT Body Width (Inches)	ET PART #	Drawing#
20	0.600	0.65	20-ML02	N/A	AS-DIP20.6-20ML02S-GEN	F6259
28	0.600	0.55	28-TS05	11.80	AS-DIP28.6Z-028-TS05S-1-S	F1044
28	0.600	0.50	28-ML03	N/A	AS-DIP28.6-28ML03S-GEN	F6260
32	0.600	0.50	32-TS01	18.40	AS-DIP32.6-032-TS01S-1-AT27C080	F4459

DIP TO QFN/MLF, TSOP PACKAGE CONVERTERS

These adapters enable you to adapt 6 to 32-pin DIPs to TSOP-type footprints. These devices have a two-piece construction: a top DIP assembly with interconnects to a TSOP surface-mountable assembly that is soldered to the target PC board and then, the top assembly is plugged onto it.

FEATURES

- Adapters can be used for prototyping SMT boards with DIP devices
- Provide interconnects to SMT patterns for testing
- Constructed with gold-plated machined pin contacts for high reliability

For a complete listing of emulator adapters pricing and delivery information, see:
 Web Link: www.1800adapter.com/093

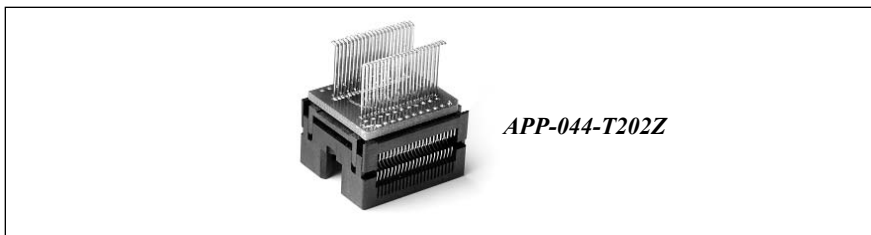

Ordering Information Example

Product Code _____ (NTP) = No Test Points
 _____ (TP) = with Test Points
 Target SMT Pads _____ AP P-048-TS01Z-(2)-(NTP)
 Pin Count _____ | 0 = w/out Production Socket
 _____ | 1 = with Production Socket
 _____ | 2 = with Burn-in Socket
 Emulation Pod Receptacle Footprint _____ Z = ZIF Socket

QFP, SOIC, TSSOP, SSOP ZIF →

QFP, SOIC, TSSOP, SSOP SMT

Pin Count	Bottom SMT Width (mm)	Lead Pitch (mm)	Package Type	ET Part #	Drawing#
16	0.635	3.90	SSOP	APP-016-SS12Z-2-TP	F5931
28	1.27	7.62	SOIC	APP-028-SO03Z-2-NTP	F4347
30	0.80	11.00	SSOP	APP-030-SS36Z-2	F6156
32	1.27	10.16	TSOPII	APP-032-T202Z-2	F6286
32	0.50	18.40	TSOP	APP-032-TS01Z-2	F5069
40	0.50	18.40	TSOP	APP-040-TS01Z-2	F2420
44	0.80	10.16	TSOPII	APP-044-T212Z-2	F2098
48	0.50	18.40	TSOP	APP-048-TS01Z-2	F4339
50	0.80	10.16	TSOPII	APP-050-T212Z-2	F5736
54	0.80	10.16	TSOPII	APP-054-T212Z-2	F1031
56	0.50	18.40	TSOP	APP-056-TS01Z-2	F1662
64	0.80	12.00	TSOP	APP-064-SS11Z-2-TP	F5944
86	0.50	10.16	TSOPII	APP-086-T232Z-2	F6229
100	0.50	ZIF	QFP	APP-100-QF49Z-NTP	F4451
132	0.635	AMP	QFP	APP-132-QF0A-0-NTP	F2411
132	0.635	AMP	QFP	APP-132-QF03A-1-TP	F1175
144	0.650	AMP	QFP	APP-144-QF10A-1-TP	F1678

QFP, SOIC, TSSOP, SSOP ZIF TO TSOP PACKAGE CONVERTERS

These adapters enable you to convert a surface mount pad footprint to a test socket.

HOW TO ORDER

- 1) Locate the part number with the correct number of pins for the emulator pod and target socket.
- 2) All parts are wired 1-to-1, top to bottom.

Try our New Soldering Iron Systems

Temperature controlled, compact soldering systems with additional solder tips. (ESTD-SAFE version also)

Web Link: www.1800adapter.com/150

Try our Chip Quik® SMD Removal Kit

Speeds up SMD removal without requiring expensive equipment or risking the use of heat guns.

Web Link: www.1800adapter.com/046

For a complete listing of emulator adapters pricing and delivery information, see:
 Web Link: www.1800adapter.com/093

EMULATOR ADAPTERS - CLIP-ON - PLCC

CAUTION:

In most applications, user must disable (tri-state) the soldered-in PLCC device before connecting the emulator to the device.

EMULATOR TOOLS & ADAPTERS

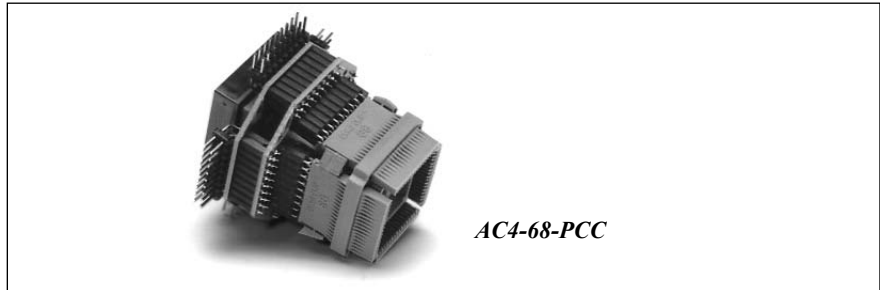
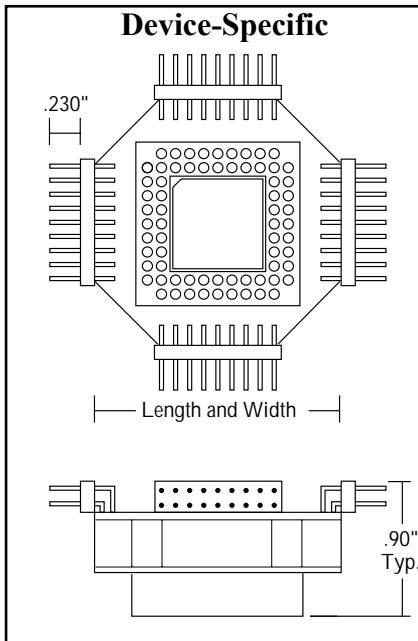
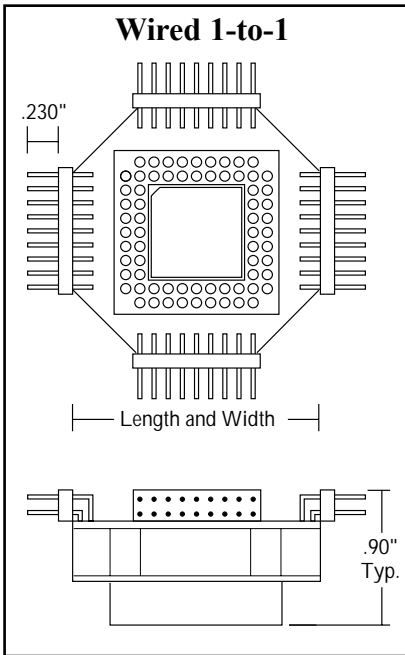

AC4-68-PCC

Wired 1-to-1 Ordering Information Example

Product Code _____ AC 4-84-PGA-(NC) _____ (NC) = No Clip
 PLCC Code _____ Emulator Pod Female Receptacle
 Pin Count _____

Device-Specific Ordering Information Example

Product Code _____ AC-PGA2-PCC-68000/10-(NC) _____ (LP) = Low Profile (NC) = No Clip
 Emulator Pod Female Receptacle _____ IC to be Emulated
 PLCC Pkg. _____

Emulator Pod → Target Socket Icons identify your emulator pod and target socket.

Wired 1-to-1		Device-Specific																																																																		
<p>PGA → PLCC</p> <table border="1"> <thead> <tr> <th>Description #</th> <th>Document #</th> </tr> </thead> <tbody> <tr> <td>AC4-68-PGA</td> <td>F2060</td> </tr> <tr> <td>AC4-84-PGA</td> <td>F2343</td> </tr> </tbody> </table>	Description #	Document #	AC4-68-PGA	F2060	AC4-84-PGA	F2343	<p>PLCC → PLCC</p> <table border="1"> <thead> <tr> <th>Description #</th> <th>Document #</th> </tr> </thead> <tbody> <tr> <td>AC4-32-PCC</td> <td>F1703</td> </tr> <tr> <td>AC4-44-PCC</td> <td>F2149</td> </tr> <tr> <td>AC4-52-PCC</td> <td>F2329</td> </tr> <tr> <td>AC4-68-PCC</td> <td>F1393</td> </tr> <tr> <td>AC4-84-PCC</td> <td>F2341</td> </tr> </tbody> </table>	Description #	Document #	AC4-32-PCC	F1703	AC4-44-PCC	F2149	AC4-52-PCC	F2329	AC4-68-PCC	F1393	AC4-84-PCC	F2341	<p>Intel</p> <table border="1"> <thead> <tr> <th colspan="2">DIP → PLCC</th> </tr> <tr> <th>Description #</th> <th>Document #</th> </tr> </thead> <tbody> <tr> <td>AC-DIP-PCC-8031/51-(NC)</td> <td>F2304</td> </tr> <tr> <td>AC-DIP-PCC-8086/88</td> <td>F1363</td> </tr> </tbody> </table> <table border="1"> <thead> <tr> <th colspan="2">PGA → PLCC</th> </tr> <tr> <th>Description #</th> <th>Document #</th> </tr> </thead> <tbody> <tr> <td>AC4-68-PGA1-8051GB</td> <td>F4331</td> </tr> <tr> <td>AC-PGA-PCC-80186/88</td> <td>F1310</td> </tr> <tr> <td>AC-PGA1-PCC5-80186EB</td> <td>F2293</td> </tr> </tbody> </table> <table border="1"> <thead> <tr> <th colspan="2">PLCC → PLCC</th> </tr> <tr> <th>Description #</th> <th>Document #</th> </tr> </thead> <tbody> <tr> <td>AC-PCC1-PCC1-80186/88-(LP)</td> <td>F4068</td> </tr> </tbody> </table>	DIP → PLCC		Description #	Document #	AC-DIP-PCC-8031/51-(NC)	F2304	AC-DIP-PCC-8086/88	F1363	PGA → PLCC		Description #	Document #	AC4-68-PGA1-8051GB	F4331	AC-PGA-PCC-80186/88	F1310	AC-PGA1-PCC5-80186EB	F2293	PLCC → PLCC		Description #	Document #	AC-PCC1-PCC1-80186/88-(LP)	F4068	<p>Motorola</p> <table border="1"> <thead> <tr> <th colspan="2">PGA → PLCC</th> </tr> <tr> <th>Description #</th> <th>Document #</th> </tr> </thead> <tbody> <tr> <td>AC-PGA2-PCC-68000/10-NC</td> <td>F2318</td> </tr> </tbody> </table> <table border="1"> <thead> <tr> <th colspan="2">DIP → PLCC</th> </tr> <tr> <th>Description #</th> <th>Document #</th> </tr> </thead> <tbody> <tr> <td>AC-DIP-PCC-68000/10</td> <td>F1665</td> </tr> <tr> <td>AC-DIP-PCC-68000/10-NC</td> <td>F2300</td> </tr> </tbody> </table>	PGA → PLCC		Description #	Document #	AC-PGA2-PCC-68000/10-NC	F2318	DIP → PLCC		Description #	Document #	AC-DIP-PCC-68000/10	F1665	AC-DIP-PCC-68000/10-NC	F2300	<p>Hewlett Packard</p> <table border="1"> <thead> <tr> <th colspan="2">PGA → QFP</th> </tr> <tr> <th>Description #</th> <th>Document #</th> </tr> </thead> <tbody> <tr> <td>AC-144P7-QF01-HP</td> <td>F4520</td> </tr> <tr> <td>AC-144P7-QF03-HP</td> <td>F4316</td> </tr> </tbody> </table>	PGA → QFP		Description #	Document #	AC-144P7-QF01-HP	F4520	AC-144P7-QF03-HP	F4316
Description #	Document #																																																																			
AC4-68-PGA	F2060																																																																			
AC4-84-PGA	F2343																																																																			
Description #	Document #																																																																			
AC4-32-PCC	F1703																																																																			
AC4-44-PCC	F2149																																																																			
AC4-52-PCC	F2329																																																																			
AC4-68-PCC	F1393																																																																			
AC4-84-PCC	F2341																																																																			
DIP → PLCC																																																																				
Description #	Document #																																																																			
AC-DIP-PCC-8031/51-(NC)	F2304																																																																			
AC-DIP-PCC-8086/88	F1363																																																																			
PGA → PLCC																																																																				
Description #	Document #																																																																			
AC4-68-PGA1-8051GB	F4331																																																																			
AC-PGA-PCC-80186/88	F1310																																																																			
AC-PGA1-PCC5-80186EB	F2293																																																																			
PLCC → PLCC																																																																				
Description #	Document #																																																																			
AC-PCC1-PCC1-80186/88-(LP)	F4068																																																																			
PGA → PLCC																																																																				
Description #	Document #																																																																			
AC-PGA2-PCC-68000/10-NC	F2318																																																																			
DIP → PLCC																																																																				
Description #	Document #																																																																			
AC-DIP-PCC-68000/10	F1665																																																																			
AC-DIP-PCC-68000/10-NC	F2300																																																																			
PGA → QFP																																																																				
Description #	Document #																																																																			
AC-144P7-QF01-HP	F4520																																																																			
AC-144P7-QF03-HP	F4316																																																																			

For a complete list of
 Clip On Device Specific Adapters, please see:
 Web Link: www.1800adapter.com/093

SOIC & PLCC - PAL/EPROM EMULATOR ADAPTERS

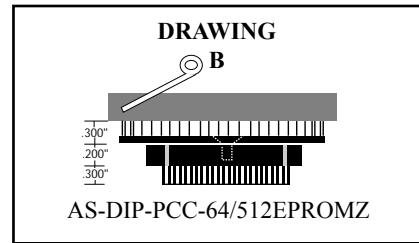
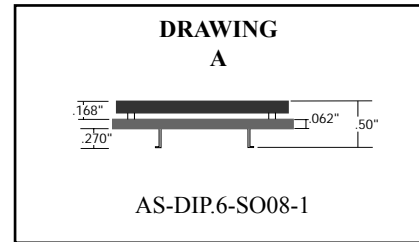
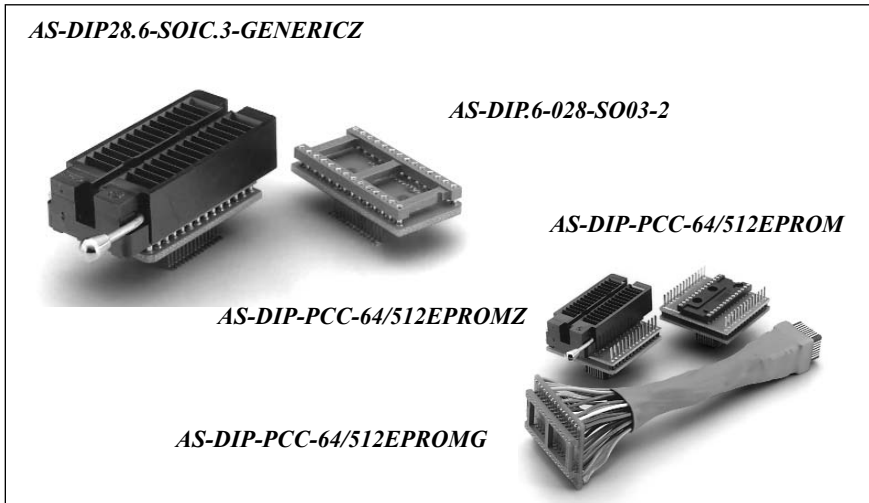

Ordering Information Example

Product Code _____ AS-DIP-SOIC-1MEG/EPROM(G) (Z) _____ EPROM Size
 DIP Device Female Receptacle _____ (Z) = ZIF Socket
 Male Plug _____ (G) = Optional Gang Version
 GENERIC = 1-to-1



Icons identify your emulator pod and target socket.

FEATURES

- Emulate your 28 and 32-pin SOIC or PLCC devices with a standard DIP device
- Test new EPROM code quickly and easily
- Convert SOIC surface mount pads, or a PLCC socket on a printed circuit board, to a zero-insertion force DIP socket
- Used with industry-standard EPROMs: 8Kx8 and 64Kx8 (2764, 27128, 27256, 27512 and 1-4 MB)

EMULATOR TOOLS & ADAPTERS

EPROM - Surface Mountable		EPROM - Socketable	
Memory Size: 64K through 512K			
DIP 28 → SOIC SMT Pads Description # Document # AS-DIP28.6-SOIC.3-GENERICZ 31960 Note: SOIC Package width = 7.62mm (.300")	DIP 28 → PLCC 32 Description # Document # AS-DIP-PCC-64/512EPROM 31152 AS-DIP-PCC-64/512EPROMZ 31178	GANG VERSION AS-DIP-PCC-64/512EPROMG 31207 Note: 5 3/4" Long Typical. AS-DIP-PCC-64/512EPROMGZ 32427 Note: 5 3/4" Long Typical.	
DIP 28 → PLCC SMT Pads AS-DIP-PCCS-512EPROM 32204			
DIP 28 → LCC SMT Pads AS-DIP-LCC-64/512EPROM 31600 AS-DIP-LCC-64/512EPROMZ 31601			
Memory Size: 1MB through 4MB			
DIP 32 → SOIC SMT Pads Description # Document # AS-DIP32.6-SOIC.4-GENERIC 31145 Note: SOIC package width = 10.2mm (.400") AS-DIP32.6-SOIC.4-GENERICZ 31086 Note: SOIC package width = 10.2mm (.400")	DIP 32 → PLCC 32 Description # Document # AS-DIP-PCC-1MEG/EPROM 31855 AS-DIP-PCC-1MEG/EPROMZ 31455 AS-DIP-PCC-1MEG/EPROMG 31666 AS-DIP-PCC-1MEG/EPROMGZ 31667 AS-DIP-PCC-27C4096 31519		
SDIP 28 → SOIC SMT Pads AS-SDP4-028-SO05-2 32086			
PAL - PLCC Wired 1-to-1			
Description #	Document #		
AS-DIP28-PCC6-GENRC	33851	Note: Wired 1-to-1	

For a complete listing of SOIC, PLCC PAL/EPROM emulator adapters and additional information, please see:
 Web Link: www.1800adapter.com/029

EMULATOR ADAPTERS - SMT REPLACEMENT BASES, PQFP/TQFP

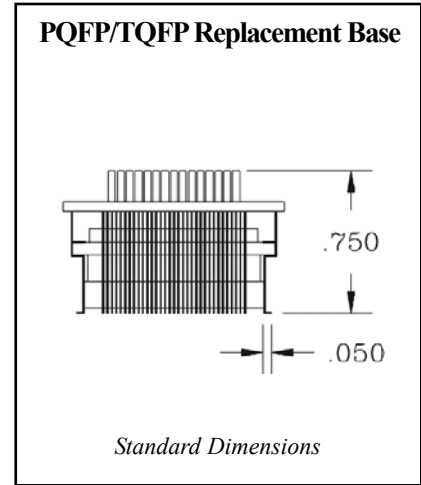
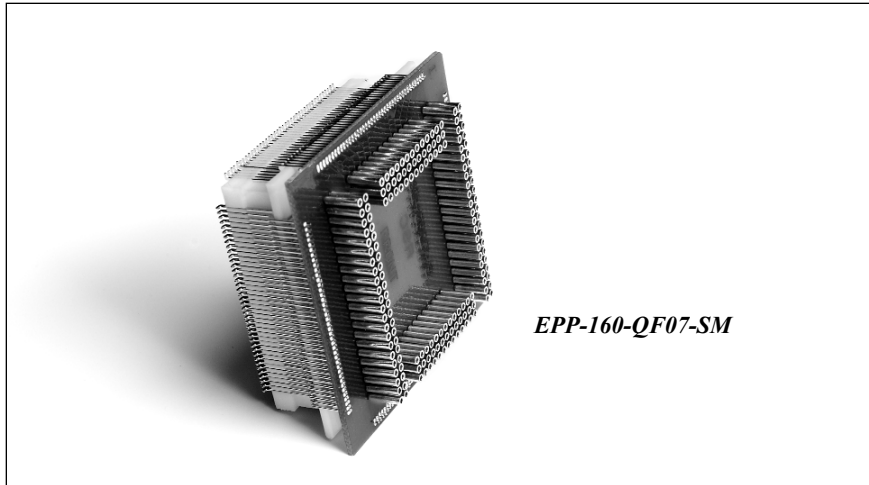

Ordering Information Example

Product Code _____ EP P-160-QF07-SM _____ SM = Small Base
 Target Surface Mount Pads _____ QFP Package Footprint (see Footprint Section)
 Pin Count _____



SMT Replacement Bases			
QFP	→	Surface Mount Pad	
Description		Document #	
EPP-044-QF16-SM		F1067	
EPP-044-QF16D-SM		F4319	
EPP-044-QF24-SM		F3983	
EPP-044-QF52-SM		F1643	
EPP-052-QF37-SM		F1642	
EPP-052-QF39-SM		F1632	
EPP-052-QF39D-SM		F4574	
EPP-064-QF09-SM		F1286	
EPP-064-QF29-SM		F1196	
EPP-064-QF29D-SM		F1328	
EPP-064-QF64-SM		F1153	
EPP-080-QF08-SM		F1368	
EPP-080-QF14A-SM		F1199	
EPP-080-QF14D-SM		F3886	
EPP-080-QF47-SM		F2007	
EPP-094-QF32-SM		F1357	
EPP-100-QF01-SM		F1713	
EPP-100-QF06-SM		F4337	
EPP-100-QF06B-SM		F3856	
EPP-100-QF49-SM		F1634	
EPP-120-QF70C/D-SM		F4335	
QFP	→	Surface Mount Pad	
Description		Document #	
EPP-128-QF13-SM		F1204	
EPP-128-QF51A-SM		F5411	
EPP-128-QF13-LG		F4225	
EPP-128-QF51-SM		F2216	
EPP-128-QF53-SM		F5616	
EPP-132-QF03-SM		F1640	
EPP-144-QF10-SM		F1360	
EPP-144-QF63-SM		F1631	
EPP-160-QF07-SM		F1556	
EPP-164-QF04-SM		F3639	
EPP-172-QF12-SM		F1362	
EPP-176-QF67-SM		F1109	
EPP-184-QF31-SM		F5658	
EPP-196-QF15-SM		F4313	
EPP-208-QF21-SM		F1225	
EPP-208-QF21D-SM		F4580	
EPP-240-QF62-SM		F1793	
EPP-256-QF17-SM		F5567	
EPP-256-QF38-SM		F4582	
EPP-256-QF42-SM		F4413	
EPP-304-QF61-SM		F2189	
SSOP	→	Surface Mount Pad	
EPP-056-SS06-SM		F5464	
EPP-056-SS09-SM		F4735	
EPP-056-SS15-SM		F4736	

HIGH QUALITY (SMT) REPLACEMENT BASES

- These replacement bases are the highest quality in the industry.
- The base material used is TEFLON®. These units will withstand ALL soldering methods without deforming or melting--including hand soldering.
- Precision machining ensures accurate pitch, size, and other physical characteristics. Tolerances: +/- 0.001"
- Vertical clearance = 0.5"

HOW TO ORDER

- 1) Determine the footprint of your device (see Footprint Section), such as QF16, and find the ET part with the same footprint.

For a complete listing of emulator adapters pricing and delivery information, see:
 Web Link: www.1800adapter.com/023

PQFP/TQFP - SURFACE MOUNTABLE - EMULATOR PODS

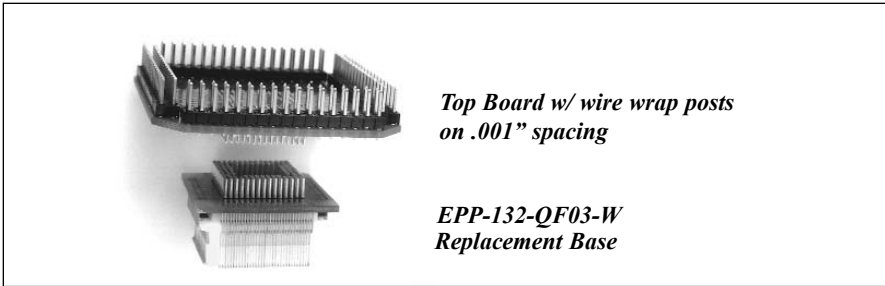

Ordering Information Example

Pin Count _____
 Product Code _____ EP P-100-QF06-*
 Male Plug _____ Male Plug Footprint (see Footprint Section)
 P = Surface Mountable Plug

[NW = No Wire Wrap Posts
 W = Wire Wrap Posts
 12/18 = Cable Length (inches)]

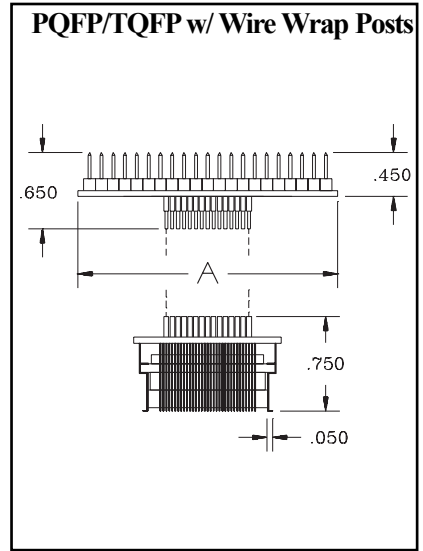

PQFP/TQFP			PQFP/TQFP		
Description	Document #	Surface Mount Footprint Available on Top Board	Description	Document #	Surface Mount Footprint Available on Top Board
EPP-044-QF16D-W	F5564	NO	EPP-100-QF06-18	F1928	NO
EPP-044-QF16-W	F2022	NO	EPP-100-QF49-W	F1880	YES
EPP-044-QF16-18	F1306	NO	EPP-112-QF36-W	F4474	YES
EPP-052-QF37-W	F4170	NO	EPP-128-QF13-W	F3963	NO
EPP-064-QF09-W	F1920	NO	EPP-128-QF53-W	F5566	NO
EPP-064-QF64-W	F1735	NO	EPP-132-QF03-W	F1228	NO
EPP-064-QF29-18	F2558	YES	EPP-144-QF10-W	F1429	NO
EPP-064-QF29-W	F4108	YES	EPP-144-QF63-W	F1736	NO
EPP-080-QF08-NW	F2563	NO	EPP-160-QF07-NW	F2566	NO
EPP-080-QF08-W	F1198	NO	EPP-160-QF07-18	F4579	NO
EPP-080-QF08-18	F2562	NO	EPP-160-QF07-W	F1575	YES
EPP-080-QF47-W	F1932	YES	EPP-208-QF21-W	F1995	YES
EPP-100-QF01-W	F1275	NO	EPP-240-QF62-W	F2035	YES
EPP-100-QF06-W	F1285	NO	EPP-240-QF62-18	F4581	YES
EPP-100-QF06B-W	F4577	NO			
EPP-100-QF06-NW	F3978	YES			

HOW TO ORDER

- 1) Locate the part number with the correct number of pins for the emulator pod.
- 2) Select wire-wrap posts and cable length.
- 3) Verify top and bottom footprints (see Footprint Section).

EPP-132-QF03-SMLP

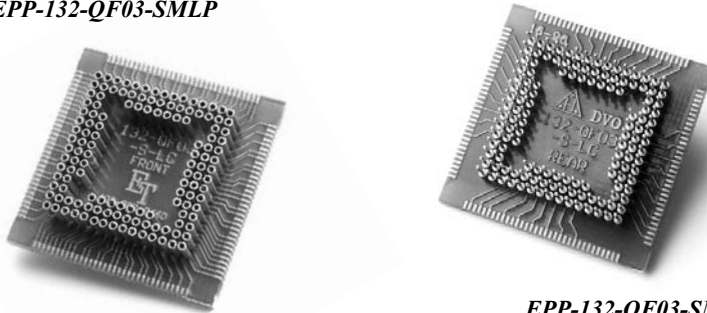

Ordering Information Example

Product Code _____ EP P-132-QF03-SMLP-M _____ SMLP=Small Base LowProfile
 Male Plug _____ Male Plug Footprint (see Footprint Section) _____ M = Male pins on top
 P = Surface Mountable Plug _____ Pin Count

PQFP

Female Pins on Top	Document #	Male Pins on Top	Document #
EPP-064-QF29B-SMLP	F5408	EPP-132-QF03-SMLP-M	F4100
EPP-080-QF14-SMLP	F4049	EPP-160-QF07-SMLP-M	F4101
EPP-100-QF06-SMLP	F4047		
EPP-128-QF13-SMLP	F4099		
EPP-132-QF03-SMLP	F3959		
EPP-160-QF07-SMLP	F4045		
EPP-208-QF21-SMLP	F4042		
EPP-240-QF62-SMLP	F4041		
EPP-352-QF71-SMLP	F5421		

LOW PROFILE, HAND SOLDERABLE, REFLOW PROCESS PQFP

- Low profile, vertical clearance 0.2", not reusable
- PCB material is FR4
- Manufacturing tolerances +/- 0.002
- Requires high precision soldering techniques (precision solder mask)
- Hand solderable

HOW TO ORDER

- 1) Determine the footprint of your device (see Footprint Section), such as QF14, and find the EPP part with the same footprint.

For a complete listing of emulator adapters pricing and delivery information, see:
 Web Link: www.1800adapter.com/023

EMULATOR PODS - SURFACE MOUNTABLE - PQFP/TQFP

EMULATION INTERCONNECT SYSTEM

Emulation Technology, Inc. now offers a time-saving Interconnect System for your fine pitch PQFP/TQFP packages. This interconnect system is specifically designed for use in the emulation/debug/development environment.

Just surface mount the PQFP/TQFP base adapter to your target board. Once the base is in place, you are free to plug in your emulator pod adapter or target chip adapter.

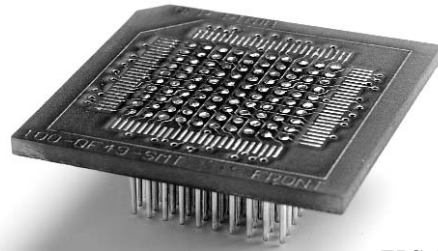

EPS-100-QF49-SM
(Target Chip Adapter)

① Target Chip Adapter

Description	Document #
EPS-080-QF14-SM	F5517
EPS-080-QF47-SM	F4584
EPS-100-QF01-SM	F4585
EPS-100-QF06-SM	F4183
EPS-100-QF49-SM	F3901
EPS-132-QF03-SM	F4307
EPS-144-QF10-SM	F4276
EPS-144-QF63-SM	F5005
EPS-176-QF67-SM	F5568

② QFP Base Adapter

Description	Document #
EPP-080-QF14A-SM	F1199
EPP-080-QF47-SM	F2007
EPP-100-QF01-SM	F1713
EPP-100-QF06-SM	F4337
EPP-100-QF49-SM	F1634
EPP-132-QF03-SM	F1640
EPP-144-QF10-SM	F1360
EPP-144-QF63-SM	F1631
EPP-176-QF67-SM	F1109

③ Emulator Pod Adapter

AX5-080-QF47/14-18
AX5-100-QF06-18
AX5-100-QF49-18

Target QFP (Quad Flat Pack) Chip

100 Pin .50mm Lead Pitch
Footprint Code: 100-QF49

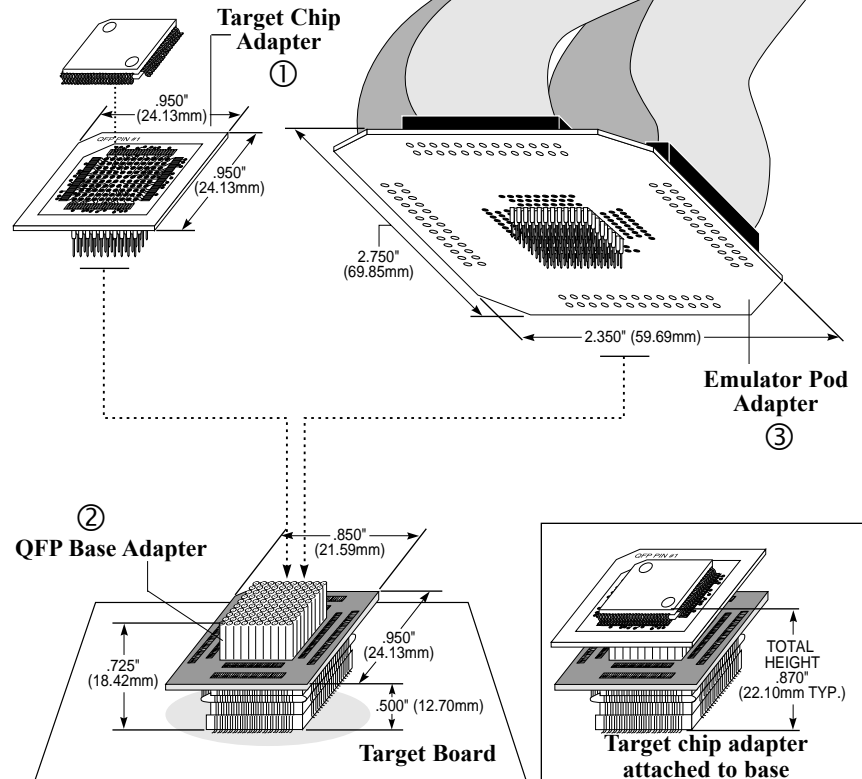

HOW TO ORDER

- 1) Determine the pin count and footprint of your device (see Footprint Section).
- 2) If you do not find an ET compatible part number for your device, call the factory or your local distributor for assistance.

For a complete listing of emulator adapters pricing and delivery information, see:

Web Link: www.1800adapter.com/093

YAMAICHI - SURFACE MOUNTABLE - EMULATOR PODS

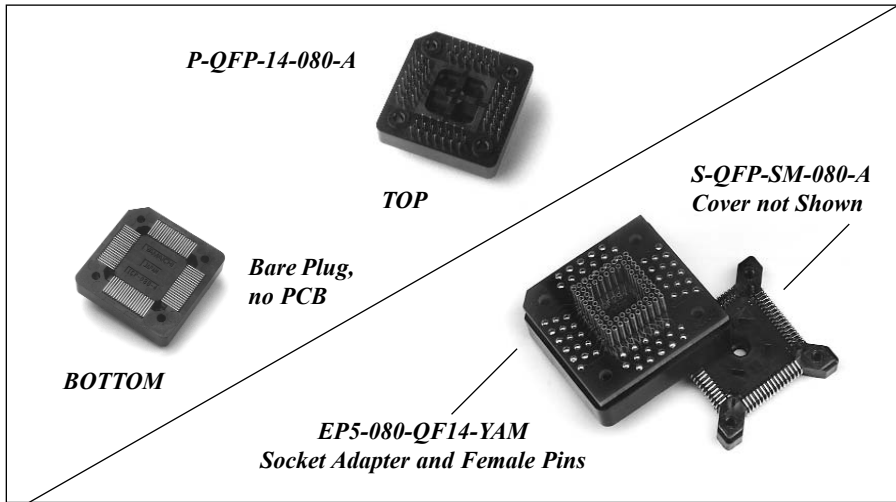

EMULATOR PLUGS FOR SURFACE MOUNT PQFP PRODUCTION SOCKETS

- Allows emulation using Yamaichi production sockets
- Small and compact
- Adapters allow you to plug in the following:

Emulator adapters

- Logic analyzer/scope adapters
- Your own custom pod or cable

Ordering Information Example

Product Code EP (5)-080-QF14-A YAM YAM = Yamaichi Socket Mount
 Male Plug: 5 = Socket Plug A = A Socket Version
 Pin Count PQFP Package Footprint (Footprint Section)

HOW TO ORDER

- 1) Determine the pin count and footprint of your device (see Footprint Section).
- 2) Select the corresponding Footprint Code in the Yamaichi PQFP Plug column of the table.
- 3) Select the corresponding socket, plug base, or plug only that you need.

Footprints (see Footprint Section)	Surface Mount Production Sockets		Socket Adapter and Female Pins		Yamaichi PQFP Plugs	
Footprint Code	Part #	Drawing #	Part #	Drawing #	Part #	Drawing #
100-QF01	S-QFP-SM-100-C	SKT429	EP5-100-QF01-YAM	F3783	P-QFP-01-100-A	SKT548
100-QF06	S-QFP-SM-100-D	SKT503	EP5-100-QF06-YAM	F2165	P-QFP-06-100-A	SKT152
160-QF07	S-QFP-SM-160-A	SKT432	EP5-160-QF07-YAM	F2129	P-QFP-07-160-A	SKT153
80-QF08-A	S-QFP-SM-080-A	SKT424	EP5-080-QF08-YAM-A	F2232	P-QFP-08-080-A	SKT154
80-QF08-B	S-QFP-SM-080-C	SKT426	EP5-080-QF08-YAM-B	F2233	P-QFP-08-080-B	SKT155
80-QF14	S-QFP-SM-080-B	SKT425	EP5-080-QF14-YAM	F2177	P-QFP-14-080-A	SKT156
64-QF29	S-QFP-SM-064-B	SKT501	EP5-064-QF29-YAM	F1791	P-QFP-29-064-A	SKT157
112-QF36	S-QFP-SM-112-A	SKT341	EP5-112-QF36-YAM	F1341	P-QFP-36-112-C	SKT158
100-QF49	S-QFP-SM-100-B	SKT428	EP5-100-QF49-YAM	F2541	P-QFP-49-100-A	SKT159
144-QF10	S-QFP-SM-144-B	SKT536	EP5-144-QF10-YAM	F5015	P-QFP-07-160-A	SKT153
144-QF63	S-QFP-SM-144-A	SKT535	EP5-144-QF63-YAM	F5397	P-QFP-63-144-A	SKT912

For a complete listing of emulator adapters pricing and delivery information, see:

Web Link: www.1800adapter.com/025

EMULATOR PODS - PGA, LCC & PLCC

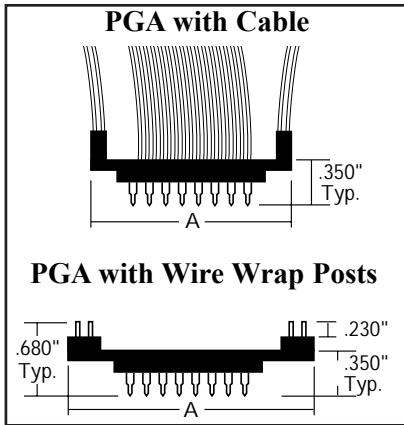

PGA

10 X 10	Document #	Dim. Δ
EP2-068-PGA2-18	F1090	1.70" SQ.
11 X 11		
EP2-068-PGA1-12	F2489	1.80" SQ.
14 X 14		
EP2-196-PGA8-18	F2509	2.40" SQ.

- Emulator pods can be wired directly to test equipment or emulators where access to a PGA or PQFP socket is required
- Available with male 0.025" square wirewrap posts or 12" or 18" cables
- Now available for soldering to PQFP SMT pads on a PC board, allows you to lay out your PC board with PQFP pads and still access your PC board with test equipment

For a complete listing of PGA emulator adapters, and additional information see:

Web Link: www.1800adapter.com/027

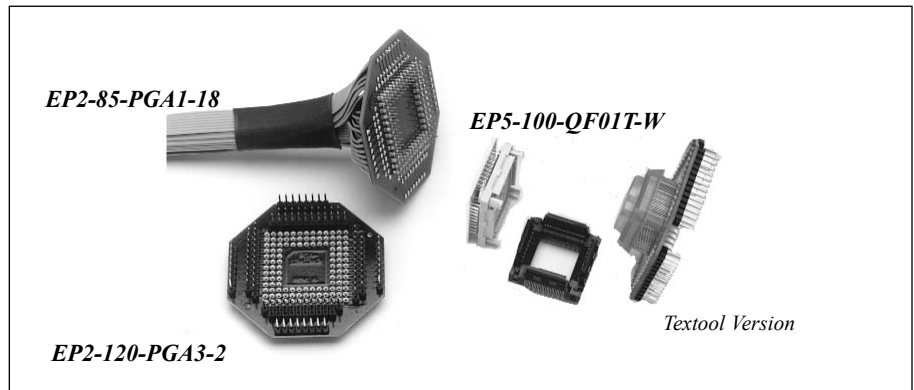
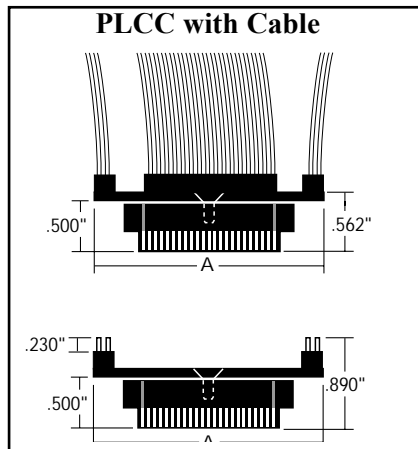

PGA Ordering Information Example

Pin Count _____
 Product Code _____ EP 5-100-PGA2-*
 Male Plug: 5 = Socket Plug _____
 Male Plug Footprint (see Footprint Section) _____

[NW] = No Wire Wrap Posts
 [W] = Wire Wrap Posts
 [12/18/36] = Cable Length (inches)
 [SM] = Small Base
 Socket Type: A = AMP, T = TEXTTOOL



Ordering Information Example

Pin Count _____
 Product Code _____ EP 4-44-PCC3-*
 Male Plug _____

[NW] = No Wire Wrap Post
 [W] = Wire Wrap Post
 [12/18] = Cable Length (inches)

Male Plug Footprint (see Footprint Section)

LCC PLCC

Description	Document #	DIM. Δ	Description	Document #	DIM. Δ
EP3-32-LCC7-12 (18)	F1818	1.20" SQ.	EP4-68-PCC1-NW	F1065	1.75" SQ.
EP3-44-LCC3-12 (18)	F1819	.65" SQ.	EP4-68-PCC1-W	F1132	1.75" SQ.
EP3-68-LCC2-12	F1825	.95" SQ.	EP4-68-PCC1-12	F2532	1.75" SQ.
EP3-68-LCC2-18	F1826	.95" SQ.	EP4-68-PCC1-18	F1617	1.75" SQ.
			EP4-84-PCC5-NW	F1119	1.95" SQ.

PLCC

Description	Document #	DIM. Δ
EP4-20-PCC2-W	F1114	.95" SQ.
EP4-20-PCC2-18	F1613	.95" SQ.
EP4-28-PCC6-W	F1115	1.35" SQ.
EP4-28-PCC6-18	F1614	1.35" SQ.
EP4-32-PCC7-W	F1555	1.2" SQ.
EP4-32-PCC7-12	F2524	1.2" SQ.
EP4-32-PCC7-18	F1113	1.2" SQ.
EP4-44-PCC3-NW	F2527	1.45" SQ.
EP4-44-PCC3-W	F1193	1.45" SQ.
EP4-44-PCC3-12	F2526	1.45" SQ.
EP4-44-PCC3-18	F1615	1.45" SQ.
EP4-52-PCC4-W	F1448	1.55" SQ.
EP4-52-PCC4-12	F2528	1.55" SQ.
EP4-52-PCC4-18	F1616	1.55" SQ.

For a complete listing of LCC & PLCC emulator adapters, please see:
 Web Link: www.1800adapter.com/025

COMPACT SIZE - PLCC - EMULATOR PODS

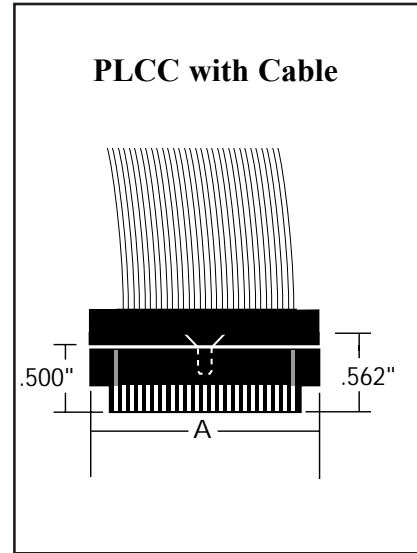
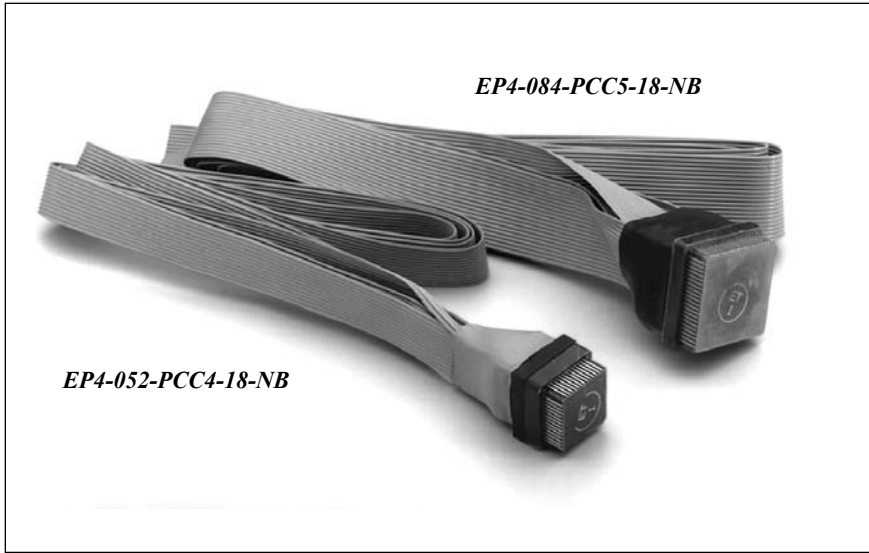

PLCC Ordering Information Example

Product Code _____ EP 4-052-PCC4-18-NB _____ ET Internal Use
 Male Plug _____ Cable Length (inches)
 Pin Count _____ Package Footprint
 (see Footprint Section)

PLCC			PLCC		
Description	Document #	DIM. A	Description	Document #	DIM. A
EP4-020-PCC2-18-NB	F2515	.50"	EP4-068-PCC1-32-NB	F1924	1.10"
EP4-028-PCC6-18-NB	F1335	.60"	EP4-084-PCC5-12-NB	F2519	1.30"
EP4-032-PCC7-12-NB	F1481	.60" X .70"	EP4-084-PCC5-18-NB	F2168	1.30"
EP4-032-PCC7-18-NB	F2126	.60" X .70"			
EP4-044-PCC3-12-NB	F2516	.80"			
EP4-044-PCC3-18-NB	F2127	.80"			
EP4-068-PCC1-12-NB	F2518	1.10"			
EP4-068-PCC1-18-NB	F1037	1.10"			

PLCC with Cable

FEATURES

- Emulator pods can be wired directly to test equipment or emulators where access to a PLCC socket is required in a confined space
- Available with 12", 18", and 32" cables
- Adapter can be used to connect a daughter board

HOW TO ORDER

- 1) Determine the footprint of your device (see Footprint Section).
- 2) Select cable length 12" or 18"
- 3) Select the corresponding ET part # from the table.

Customs available upon request.

For a complete listing of PLCC emulator adapters, and additional information see:

Web Link: www.1800adapter.com/028

PLCC Vacuum Insertion Tool

- Use this tool to easily insert PLCC packages into their sockets.
- Inserter works on PLCC packages with pin counts 28 to 84
- Conductive plastic material is an active grounding device against static charging



- Use this to extract PLCC packages from their production sockets
- Prevents bending or breaking of adjacent leads
- Puller works on PLCC packages with 20, 28, 32, 44, 52, 68, 84, and 100 pin counts

PLCC Extraction Tool



Try our PLCC Tools. Learn more about these tools and others by visiting:

Web Link: www.1800adapter.com/053



EMULATOR ADAPTERS - MLF/QFN

EMULATOR TOOLS & ADAPTERS

Easily connects to an in-circuit emulator via standard pin counts.

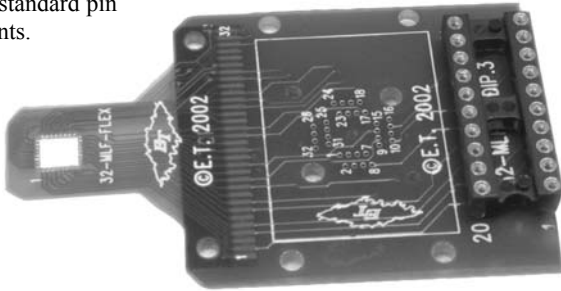

This emulator can quickly be transformed for programming and logic analysis.

EMULATE. ANALYZE. PROGRAM.

Ordering Information Example

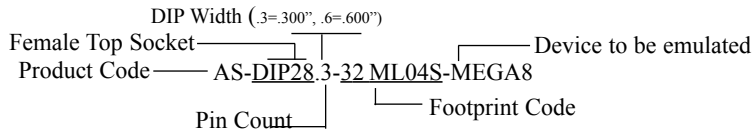

For a complete list of adapter specifications, pricing and delivery information, please see: Web Link: www.1800adapter.com/060

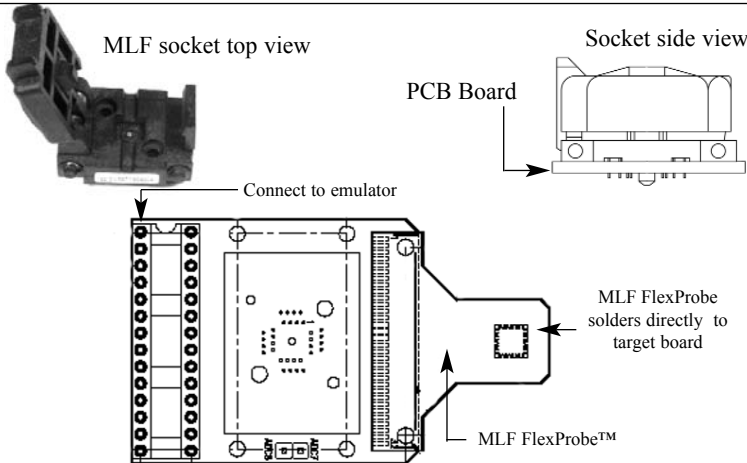

MLF/QFN 3-in-1 Adapter System™

The QFN/MLF 3-in-1 Adapter System™ ensures quick and easy configuring and interfacing to an in-circuit emulator, device programmer, logic analyzer or oscilloscope. The first of its kind, this 3-in-1 system provides the solution for test and design engineers needing QFN (Quad Flat Non-leaded) or MLF (Micro Lead Frame) signal access. This system supports the ATMEL® ATtiny26, ATtiny28, ATmega8, ATmega16 and ATmega32 8-bit AVR® Microcontrollers.

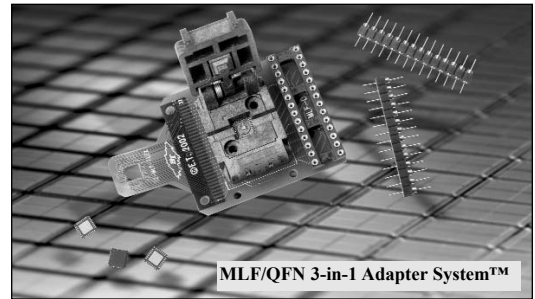

FEATURES & BENEFITS

- Reduces cost of ownership by 50-66% by eliminating the need for three separate adapters
- Change chip packages rapidly
- Flexible target interconnect minimizes physical strain on target pads
- Excellent for in-circuit or out of circuit programming
- Monitor signals - Logic Analysis
- Quick interface In-Circuit Emulator
- Compact design ensures signal integrity

MLF/QFN LOGIC ANALYZER ADAPTER (ONLY) PART NUMBERS

Logic Analyzer Adapter Only

Top DIP	Top DIP Width (Inches)	Bottom SMT SMT Pin Count	Bottom SMT Lead Pitch (mm)	Body Size	Footprint Code	ET Part #	Drawing #
28	0.300	32	0.50	5X5	32-ML04	AS-DIP28.3-32ML04S-MEGA8	F6658
20	0.300	32	0.50	5X5	32-ML04	AS-DIP20.3-32ML04S-TINY26	F6659
40	0.600	44	0.50	7X7	44-ML05	AS-DIP40.6-44ML05S-MEGA16/32	F6660
40	0.600	44	0.50	7X7	44-ML05	AS-DIP40.6-44ML05S-MEGA162	F6661

MLF/QFN 3-IN-1 ADAPTER SYSTEM PART NUMBERS

Complete 3-in-1 Adapter System

Pin Count	Pin Map	SMT Lead Pitch (mm)	Body Size	Footprint Code	ET Part #	Drawing #
32	ATMEL MEGA 8	0.50	5X5	32-ML04	BCP-032-ML04Z-MEGA8-3IN1	F6730
32	ATMEL TINY 26	0.50	5X5	32-ML04	BCP-032-ML04Z-TINY26-3IN1	F6727
44	MEGA16/32, 8535	0.50	7X7	44-ML05	BCP-044-ML05Z-MEGA16/32-3IN1	F6728
44	MEGA 162, 8515	0.50	7X7	44-ML05	BCP-044-ML05Z-MEGA162-3IN1	F6729

- Logic Analyzer Adapter
- Program Adapter
- Emulator Adapter