

SUGGESTED PCB HOLE SIZE DIMENSIONS FOR AdvancedTCA POWER CONNECTORS WITH PRESS FIT TERMINATIONS			
ACCORDING IEC 60352-5			
THROUGH HOLE PLATING		Signal Contact	Power Contact
	NOMINAL DIAMETER	1,0 mm	1,6mm
TIN-LEAD	DRILLED HOLE	1,15 ±0,025 mm	1,75 ±0,025 mm
	COPPER	min. 25µm	min. 25µm
	TIN-LEAD	min. 15µm	min. 15µm
	FINISHED HOLE	1,0 +0,09 –0,06mm	1,6 +0,09 –0,06mm
Galv./HAL TIN	DRILLED HOLE	1,15 ±0,025 mm	1,75 ±0,025 mm
	COPPER	min. 25µm	min. 25µm
	TIN	5-15µm	5-15µm
	FINISHED HOLE	1,0 +0,09 –0,06mm	1,6 +0,09 –0,06mm
CHEM. TIN	DRILLED HOLE	1,15 ±0,025 mm	1,75 ±0,025 mm
	COPPER	min. 25µm	min. 25µm
	CHEM. TIN	max. 1,5µm	max. 1,5µm
	FINISHED HOLE	1,0 +0,09 –0,06mm	1,6 +0,09 –0,06mm

Connector Technical Data

Material and Finishes

Insulator glass filled plastic, UL 94V-0 Contacts Materials high precision machined copper alloy Plating gold flash over nickel / 30 micro inch, gold over nickel (pressfit termination tin over nickel)

Electrical Characteristics

Contact Current Ratings, per UL 1977,

(see temperature rise curve for details) Size 16 power contacts 30 A continuous all contacts under load Size 22 signal contacts 2 A nominal rating **Initial contact resistance (termination to termination)** Size 16 power contacts 0.0022 Ω maximum Size 22 signal contacts 0.0085 Ω maximum Insulation resistance 5 G Ω per IEC 512-2 Test 3a **Voltage proof** Contacts 1-16 1000 V r.m.s. Contacts 17-34 2000 V r.m.s. **Creepage and clearance distance (minimum)** Contact positions 1-16 to any other contact within this group 0.7 mm Contact positions 17-24 to any other contact within this group 2.5 mm Contact positions 25-34 to any other contact within this group 1.4 mm Contact positions 13-16 to 17-20 3.0 mm Contact positions 21-24 to 25, 26 4.0 mm Contact positions 25, 26 to 27-29 2.0 mm Working voltage 100 V r.m.s.

Mechanical Characteristics

Blind mating system male and female connector bodies provide "lead-in" for 2.0 mm diametral misalignment Polarization provided by connector body design Fixed contacts printed board terminations,

both straight and right angle **Fixed contact retention in connector body** Size 16 contacts 31 N Size 22 contacts 25 N
Resistance to solder heat 260°C for 10 seconds duration per IEC 512-6, Test 12e
25-watt soldering iron
for other application contact factory Sequential contact mating system first mate contacts 25, 26, 28, 29, 30 and 31
second mate contact 33
third mate contact 34
contacts 1-24 mate before 27 and 32
last mate contacts 27 and 32 Mechanical operations 250 cycles Temperature range -55°C to +125°C



AdvancedTCA Male Connector

22-position
Position 1 - 4 and 17 - 24 no contacts
Press-Fit angled
Front board connector

Directive 2002/95/EC
„RoHS“
Compliant

CONNECTOR DIMENSIONS

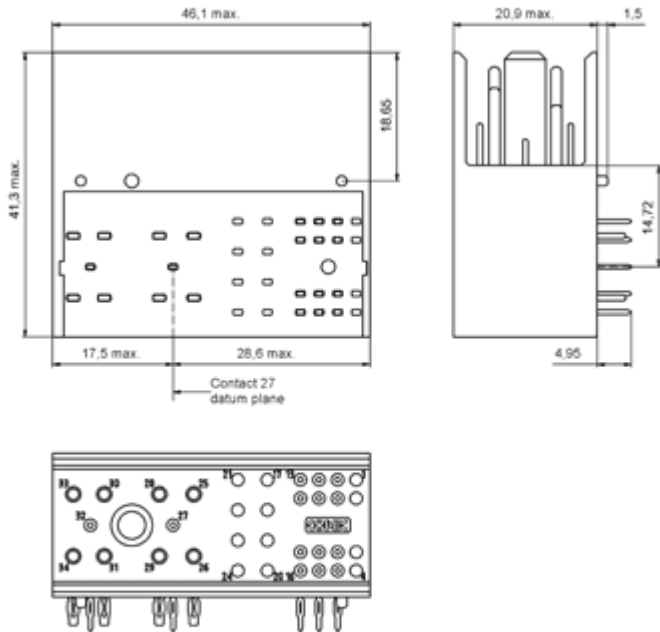

PCB-HOLE PATTERN

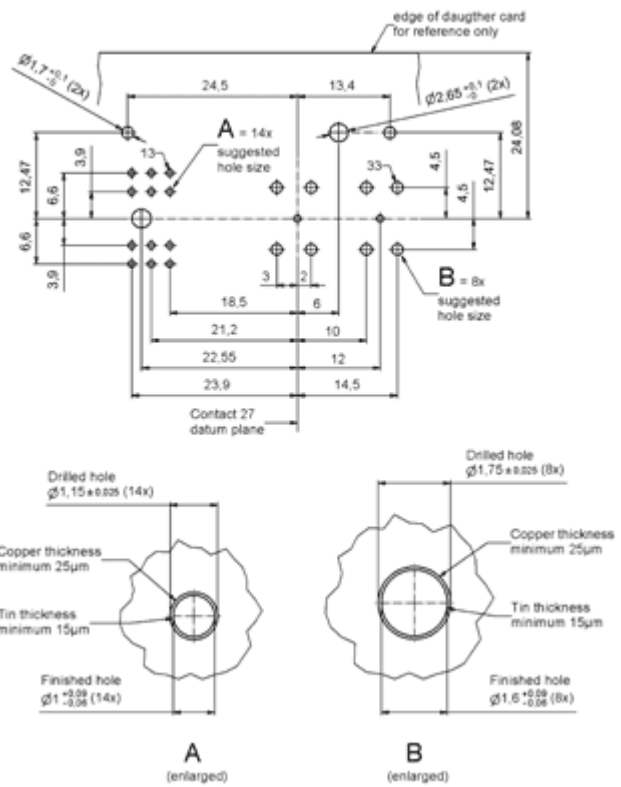

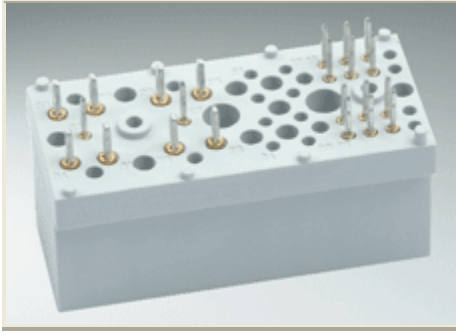

AdvancedTCA Female Connector

22-position
Position 1 - 4 and 17 - 24 no contacts
Press-Fit straight
Back plane connector

Directive 2002/95/EC
"RoHS"
Compliant

CONNECTOR DIMENSIONS

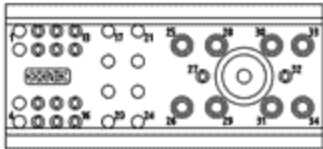
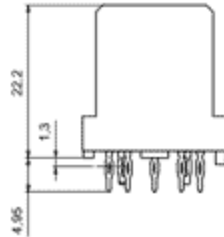
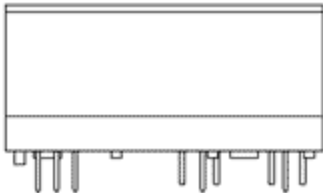
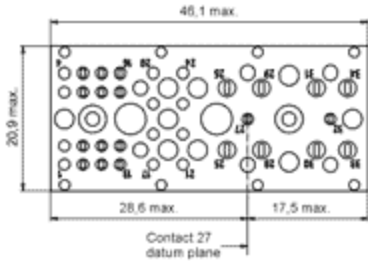

PCB-HOLE PATTERN

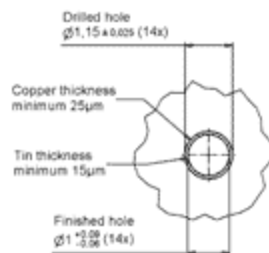
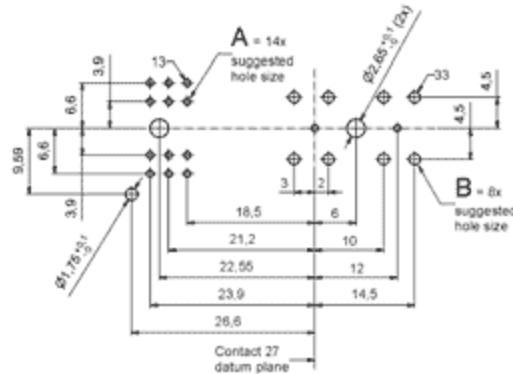

A
(enlarged)

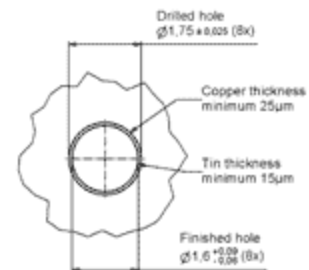

B
(enlarged)



AdvancedTCA Male Connector

30-position
Position 1 - 4 no contacts
Press-Fit angled
Front board connector

Directive 2002/95/EC
"RoHS"
Compliant

CONNECTOR DIMENSIONS

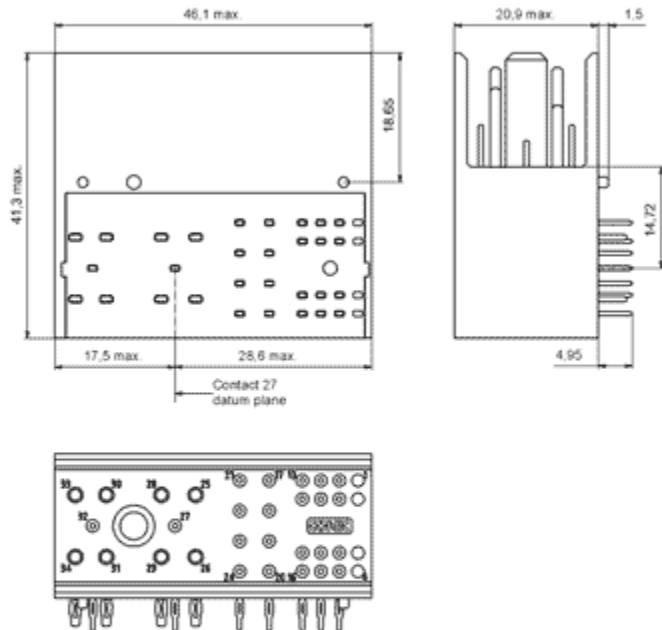

PCB-HOLE PATTERN

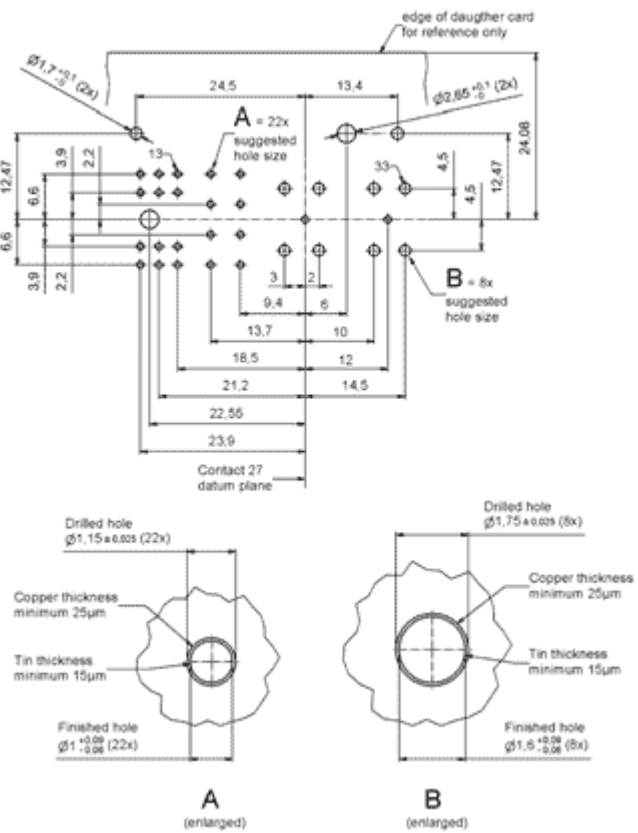

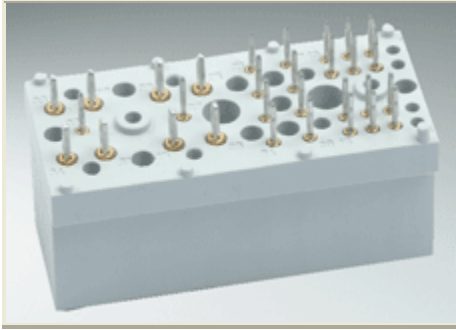

AdvancedTCA Female Connector

30-position
Position 1 - 4 no contacts
Press-Fit straight
Back plane connector

Directive 2002/95/EC
"RoHS"
Compliant

CONNECTOR DIMENSIONS

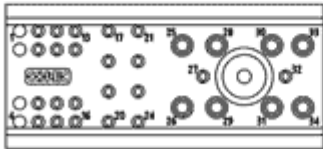
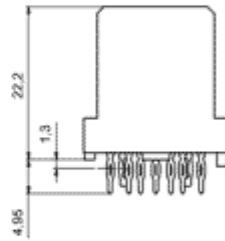
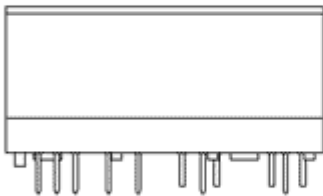
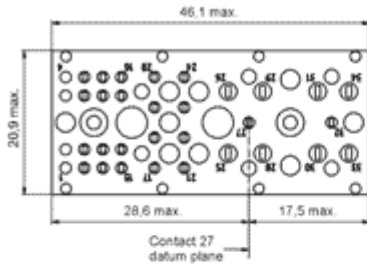

PCB-HOLE PATTERN

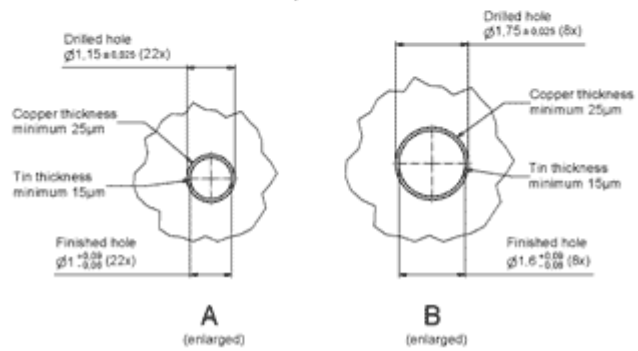
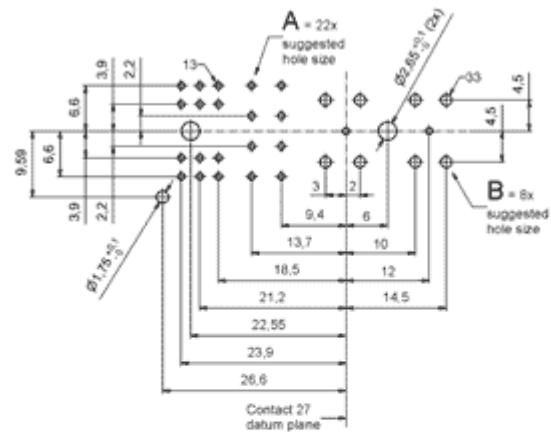



AdvancedTCA Male Connector

34-position
Press-Fit angled
Front board connector

Directive 2002/95/EC
"RoHS"
Compliant

CONNECTOR DIMENSIONS

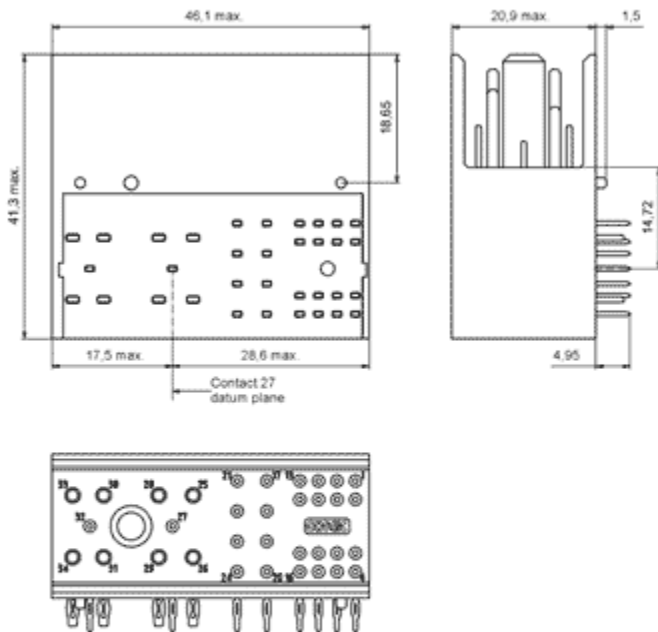

PCB-HOLE PATTERN

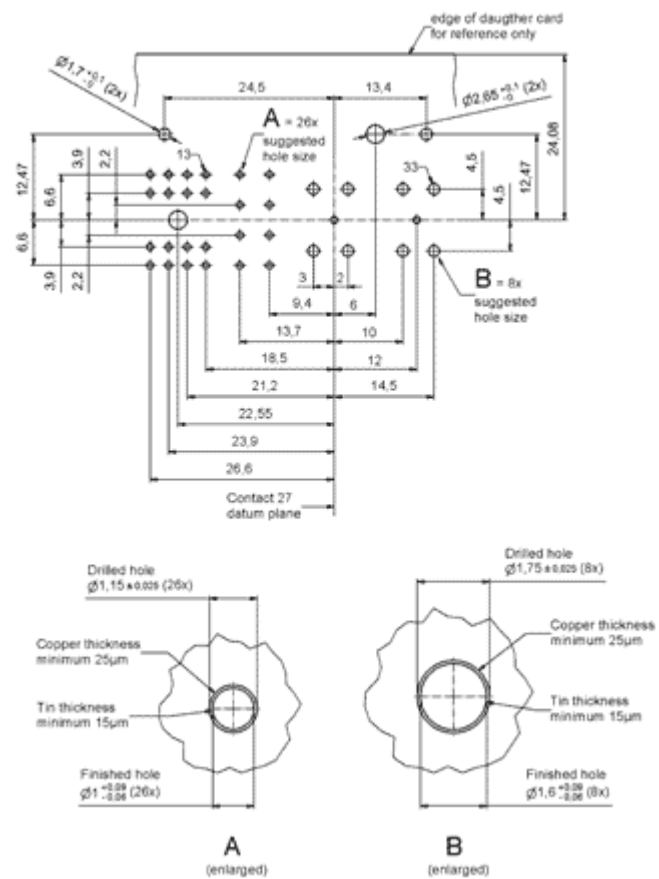

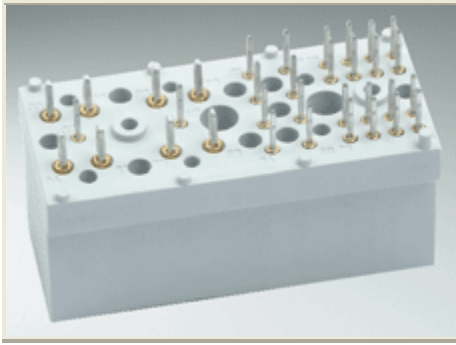

AdvancedTCA Female Connector

34-position
Press-Fit straight
Back plane connector

Directive 2002/95/EC
„RoHS“
Compliant

CONNECTOR DIMENSIONS

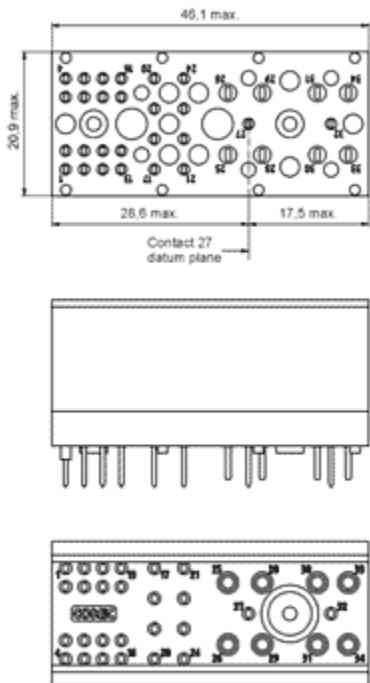

PCB-HOLE PATTERN

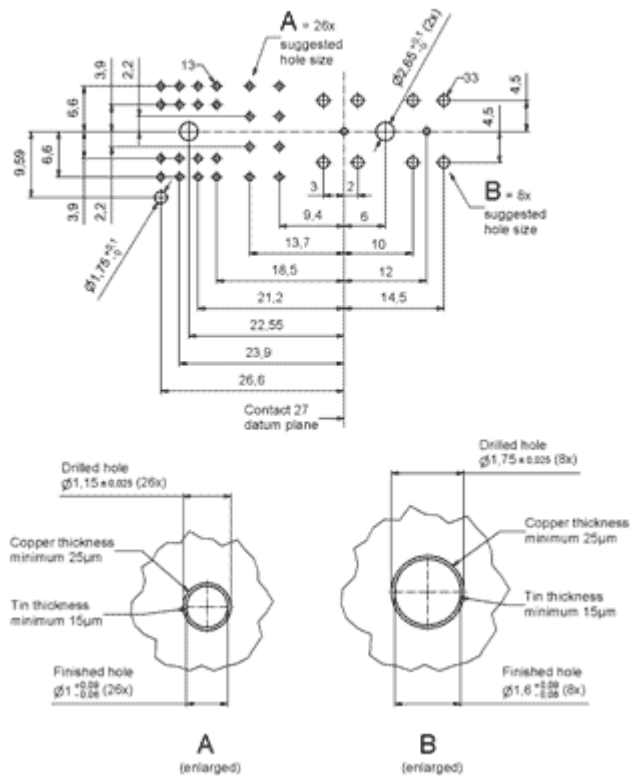



AdvancedTCA Male Connector

22-position
Position 1 - 4 and 17 - 24 no contacts
Solder pin angled
Front board connector

Directive 2002/95/EC
„RoHS“
Compliant

CONNECTOR DIMENSIONS

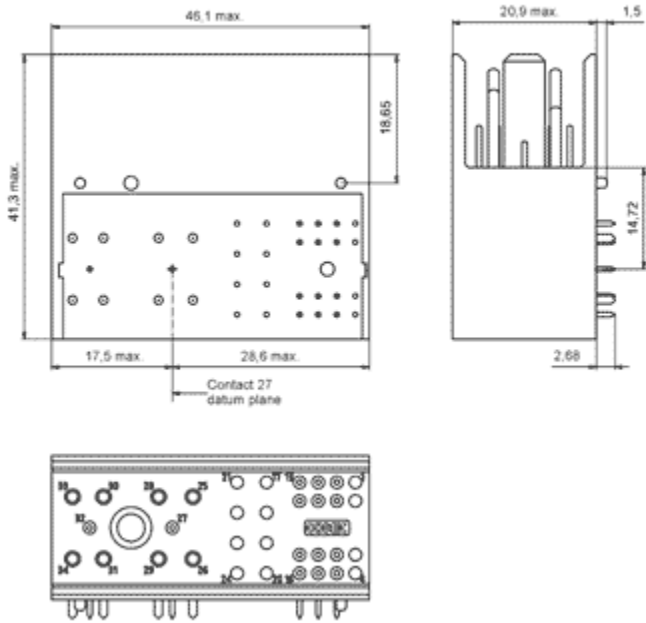

PCB-HOLE PATTERN

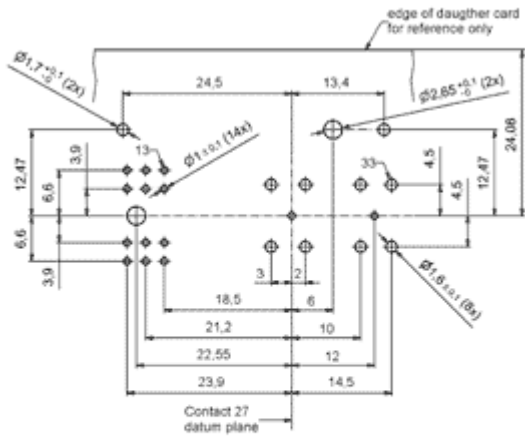



AdvancedTCA Male Connector

30-position
Position 1 - 4 no contacts
Solder pin angled
Front board connector

Directive 2002/95/EC
„RoHS“
Compliant

CONNECTOR DIMENSIONS

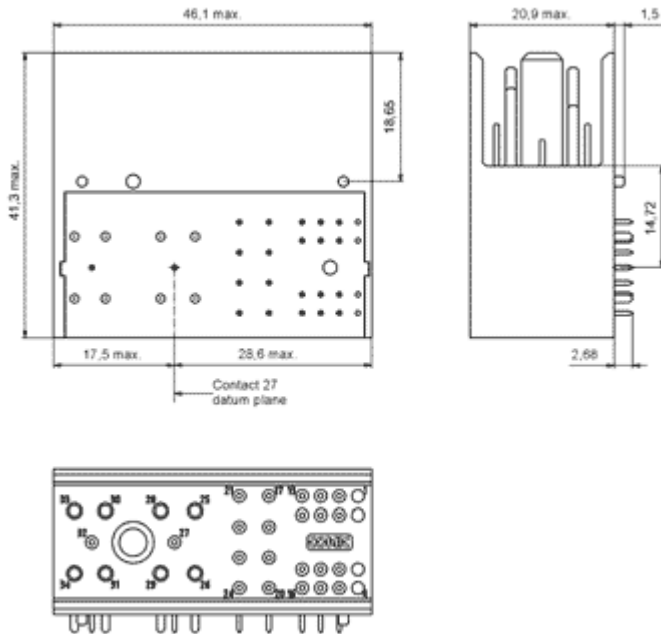

PCB-HOLE PATTERN

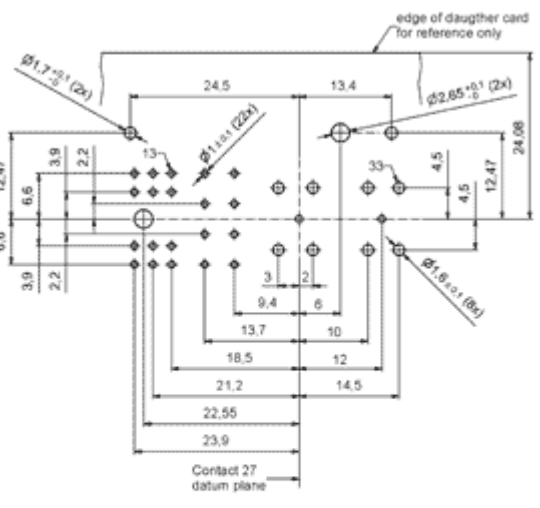

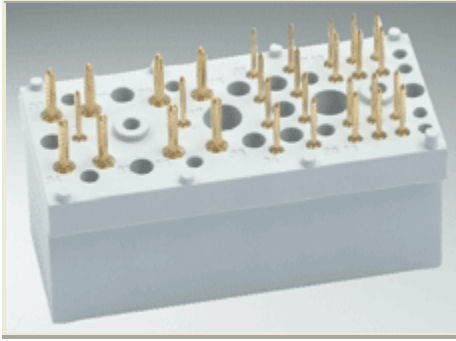

AdvancedTCA Female Connector

30-position
Position 1 - 4 no contacts
Solder pin straight
Back plane connector

Directive 2002/95/EC
"RoHS"
Compliant

CONNECTOR DIMENSIONS

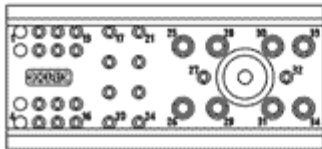
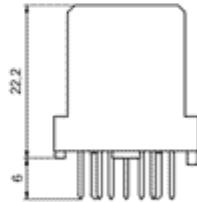
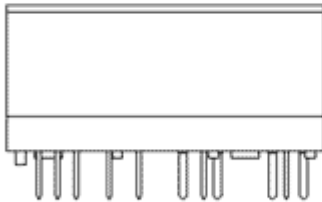
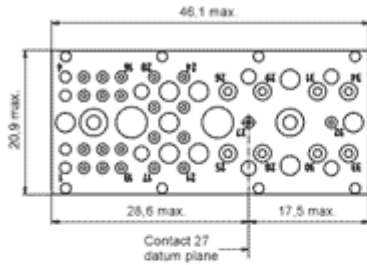

PCB-HOLE PATTERN

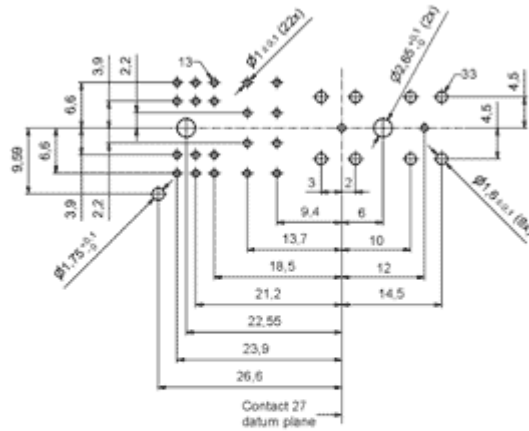

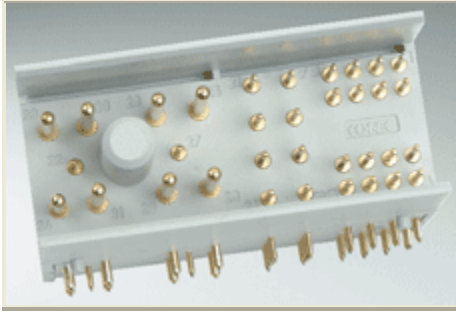

AdvancedTCA Male Connector

34-position
Solder pin angled
Front board connector

Directive 2002/95/EC
„RoHS“
Compliant

CONNECTOR DIMENSIONS

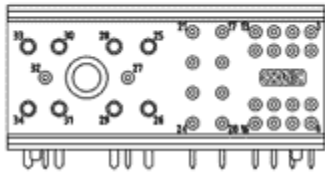
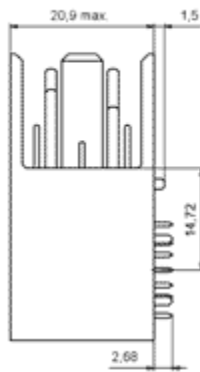
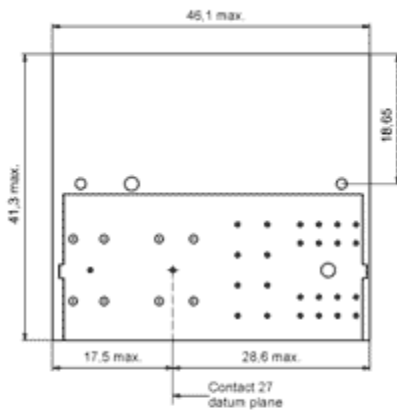

PCB-HOLE PATTERN

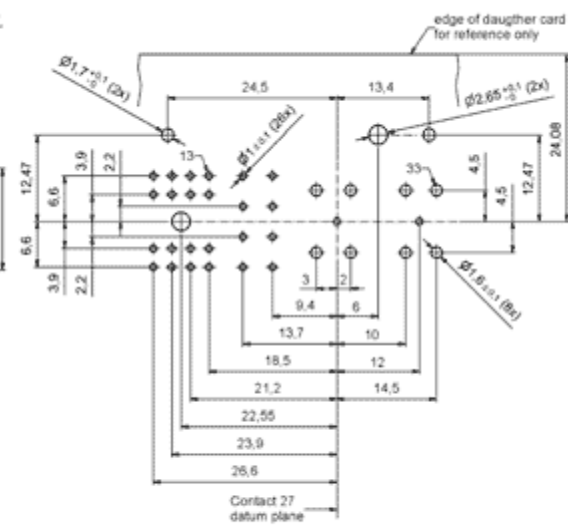

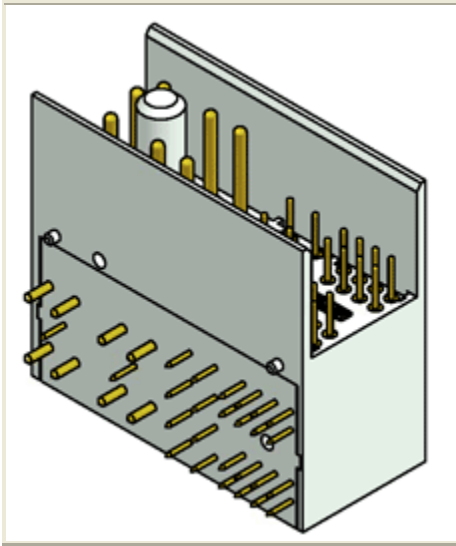

AdvancedTCA Male Connector

34-position
Solder pin angled

Directive 2002/95/EC
„RoHS“
Compliant

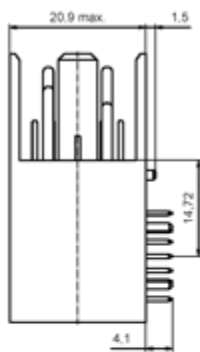
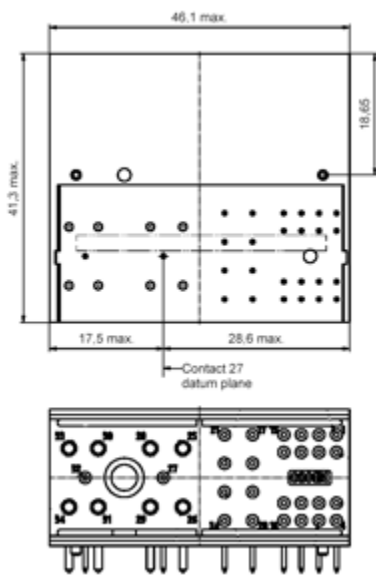

PCB hole pattern

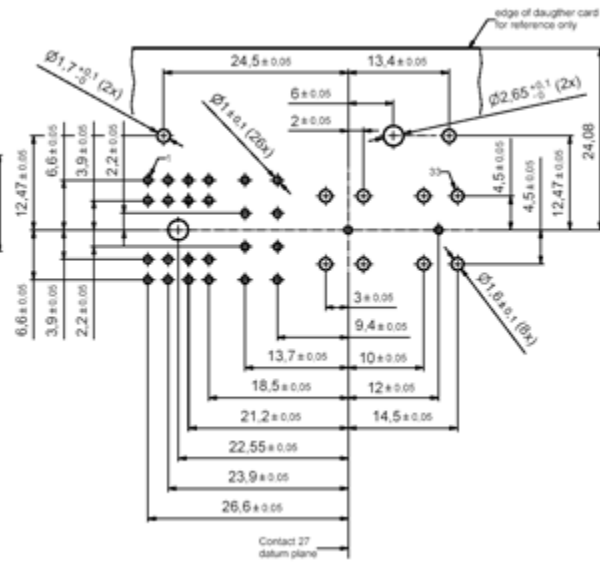

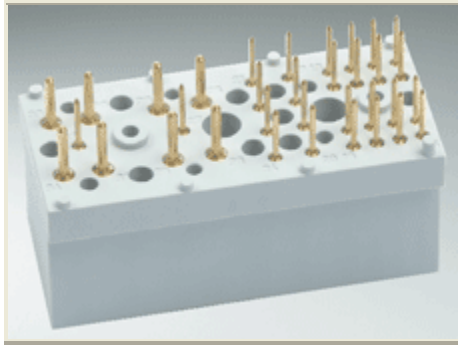

AdvancedTCA Female Connector

34-position
Solder pin straight
Back plane connector

Directive 2002/95/EC
„RoHS“
Compliant

CONNECTOR DIMENSIONS

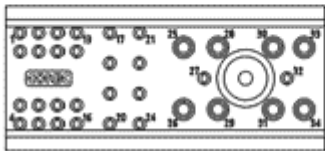
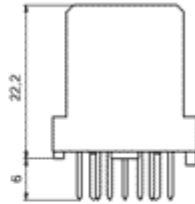
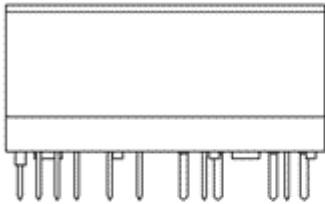
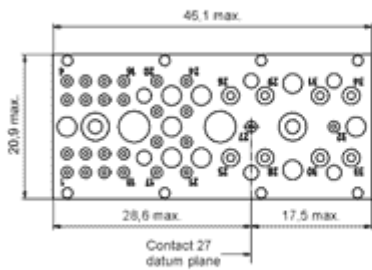

PCB-HOLE PATTERN

