

**ebm-papst St. Georgen GmbH & Co. KG**

Hermann-Papst-Str. 1

D-78112 St. Georgen

Phone +49 (0) 7724 81-0

Fax +49 (0) 7724 81-1309

info2@de.ebmpapst.com

www.ebmpapst.com

**Nominal data**

Type	514 F	
Nominal voltage	VDC	24
Nominal voltage range	VDC	21.6 .. 26.4
Speed	min <sup>-1</sup>	5000
Power input	W	0.9
Min. ambient temperature	°C	-20
Max. ambient temperature	°C	70
Air flow	m <sup>3</sup> /h	20
Sound power level	B	4.5
Sound pressure level	dB(A)	30

ml = Max. load · me = Max. efficiency · fa = Running at free air · cs = Customer specs · cu = Customer unit  
Subject to alterations



**Technical features**

<b>Mass</b>	0.027 kg
<b>Dimensions</b>	50 x 50 x 15 mm
<b>Material of impeller</b>	Fiberglass-reinforced PA plastic
<b>Housing material</b>	Fiberglass-reinforced PBT plastic
<b>Direction of air flow</b>	Air exhaust over bars
<b>Direction of rotation</b>	Left, looking at rotor
<b>Bearing</b>	Sintec sleeve bearing
<b>Lifetime L10 at 20 °C</b>	50000 h
<b>Lifetime L10 at 60 °C</b>	20000 h
<b>Connection line</b>	Single strands AWG 28, TR 64, bared and tin-plated.
<b>Motor protection</b>	Protected against reverse polarity and locking.
<b>Locked-rotor protection</b>	Impedance protection
<b>Approval</b>	VDE, CSA, UL, CE



## Product drawing

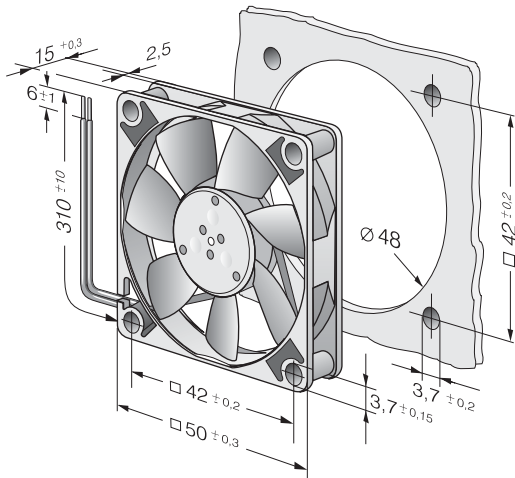

## Charts: Air flow

