

SRA Series

Robust Applications

STANDARD SERIES

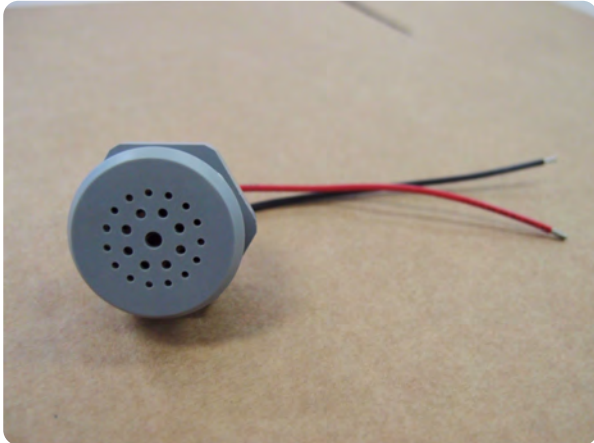

The **Sonitron Robust Application** standard series are an important extension of the Standard series.

A superior Life Time has been obtained with a very large DC voltage range from 5Vdc up to 80Vdc. Equipped with 16 AWG wires this buzzer can be used in any harsh industrial environment.

Sonitron expanded with this series a wide application field and strong reliability, especially recommended in critical applications and life support systems.

ADVANTAGES & APPLICATIONS

ADVANTAGES :

- Up to 80Vdc
- Solid state shock proof buzzer
- Life time > 2000 hours
- Very low power consumption (typical 15mA@12Vdc)
- Wrong polarity protected
- Panel mounting, O-ring included
- 16 AWG wire connections (14cm)
- High reliability

- IP67, Dust and waterproof
- Temperature range -40°C to +85°C

APPLICATIONS :

- Industrial
- Automotive Vehicles
- Process & Alarm equipment
- Security & Burglar alarms

SPECIFICATIONS

**All measurements are made @ 1 meter @ 12Vdc in free air @ 21°C*

Model	Function	MIN Vdc	MAX Vdc	Frequency +/- 15% (Hz)	Pulse Rate (Hz)	SPL dB(A) +/-4dB @1m@12Vdc*
SRA 80C A	Contin.	5V	80V	2500	-	93
SRA 80I A1	Intermit.	5V	80V	2500	1	92
SRA 80I A5	Intermit.	5V	80V	2500	5	92
SRA 80C B	Contin.	5V	80V	3500	-	95
SRA 80I B1	Intermit.	5V	80V	3500	1	94
SRA 80I B5	Intermit.	5V	80V	3500	5	94

Operating temperature	-40°C to +85°C
Storage temperature	-40°C to +85°C
Life Time (@21°C)	@12Vdc continuous use min.2000 hours (expected life time curve see catalogue p112)
Case Material	ABS (UL rating: 94HB)
Standard colour of case	Grey
Weight	34g
Max current consumption	15mA
Wire	16 AWG, 14cm

ELECTRICAL PARAMETERS

The buzzer starts sounding from 5Vdc. The sound output increases with raising voltage up to 15Vdc. From 15Vdc to maximum voltage of 80Vdc the sound output remains the same.

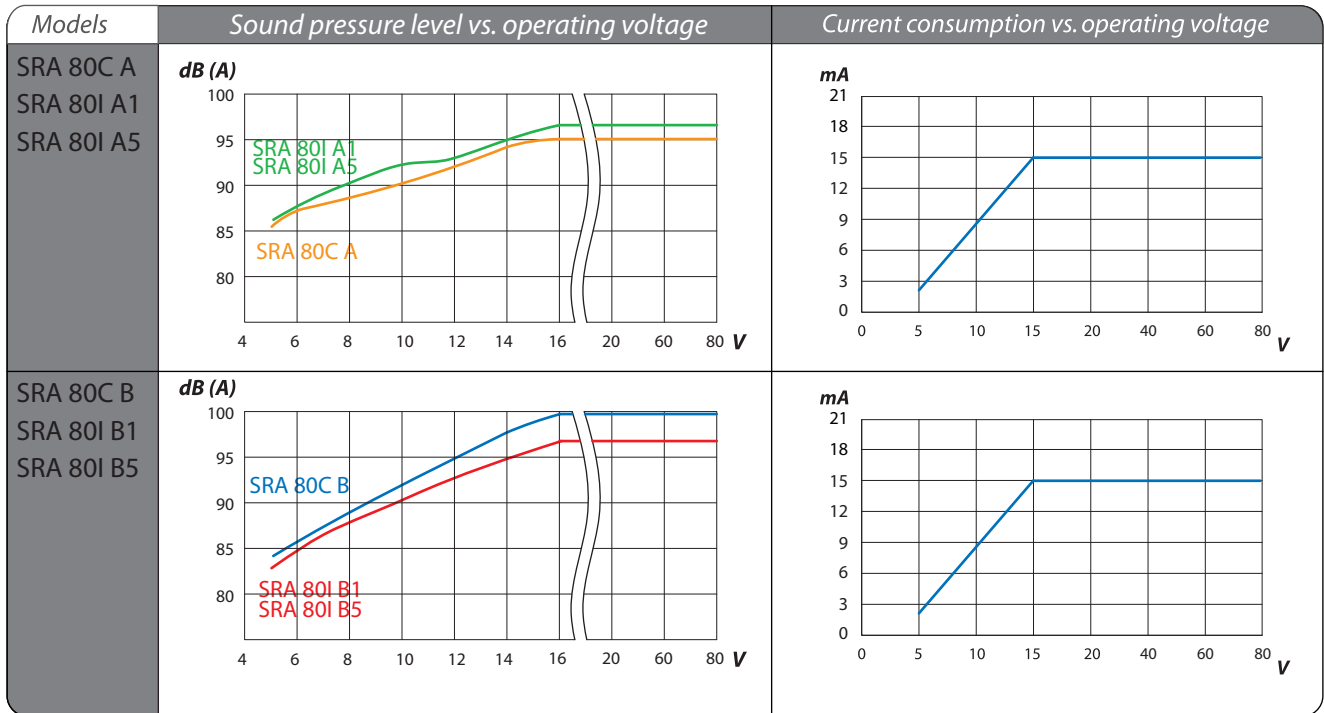

All measurements are made @ 12Vdc @ 1 meter in free air @ 21°C.

DIMENSIONS (All dimensions are in mm)

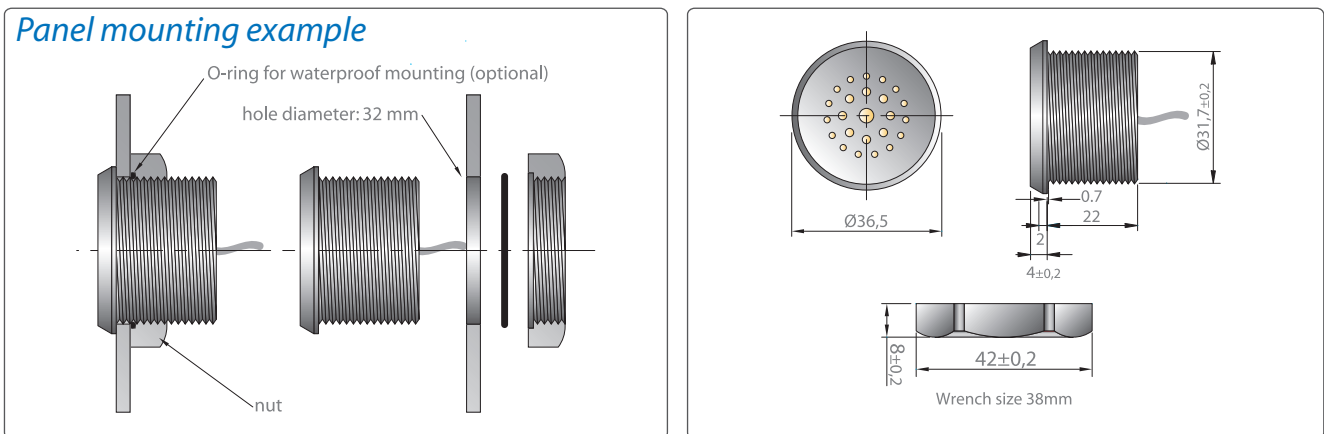
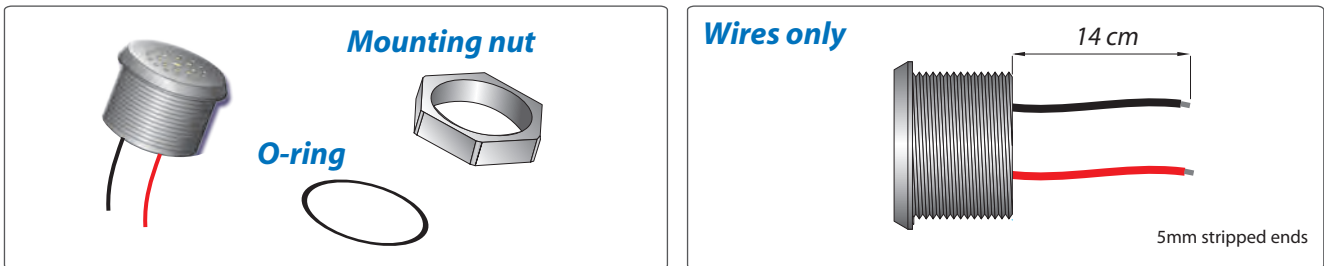

LIST OF AVAILABLE PRODUCT TYPES

SRA 80C A	SRA 80I A1	SRA 80I A5
SRA 80C B	SRA 80I B1	SRA 80I B5