

Leiterplatten-Layout Vorschlag für SMT  
PCB-Layout Proposal for SMT

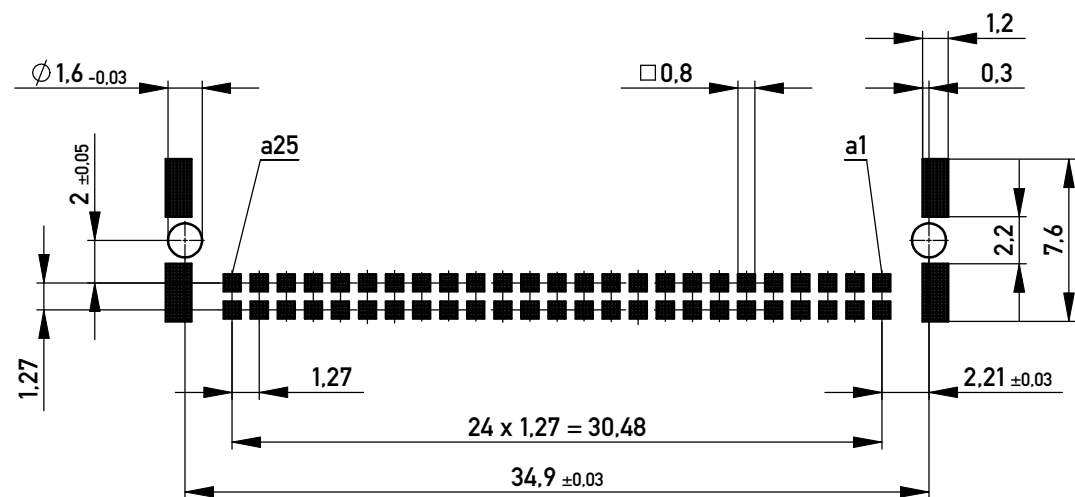

Anforderungsstufe 1  
Performance Level 1

Kontaktbereich vergoldet  
Mating Area gold plating

Anschlussbereich verzinkt 4-6  $\mu\text{m}$   
Terminal Area 4-6  $\mu\text{m}$  tin plating

Koplanarität der Anschlüsse  $\leq 0.1$  mm  
Coplanarity Area of Termination  $\leq 0.1$  mm

Verpackt in Gurtverpackung - Tape on Reel Packaging  
Verpackungseinheit: 560 Stück - Packaging unit: 560 pcs

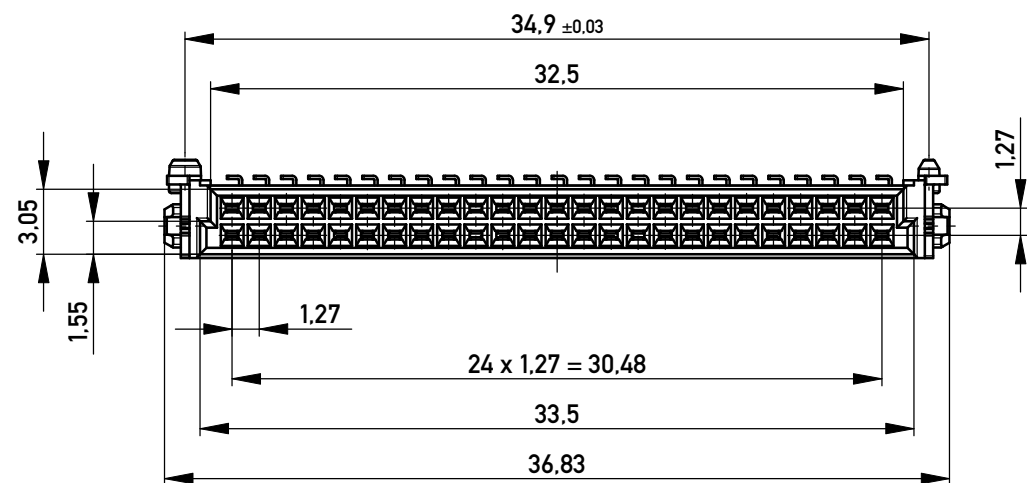
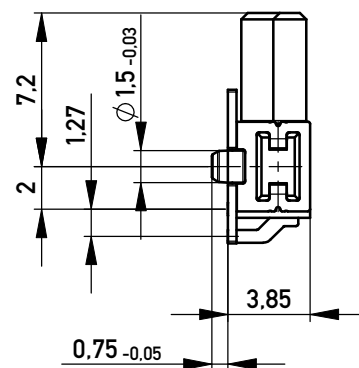
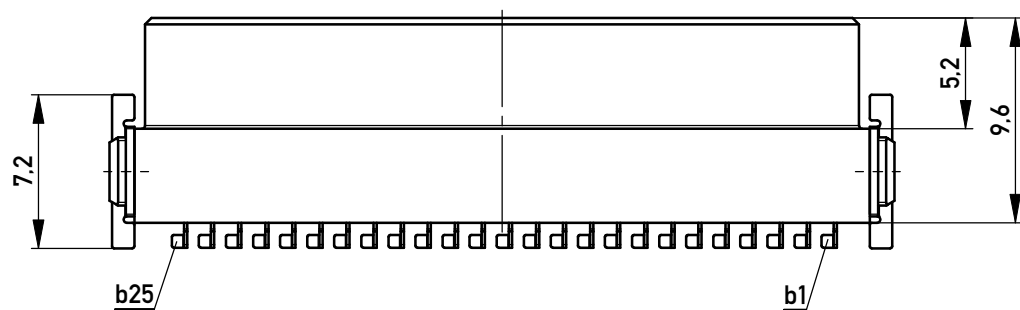
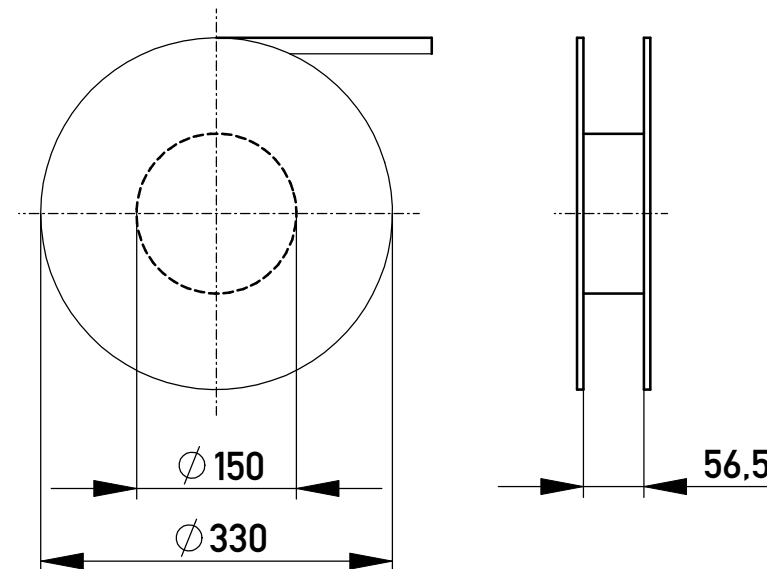

Abspulrichtung - Reel off Direction

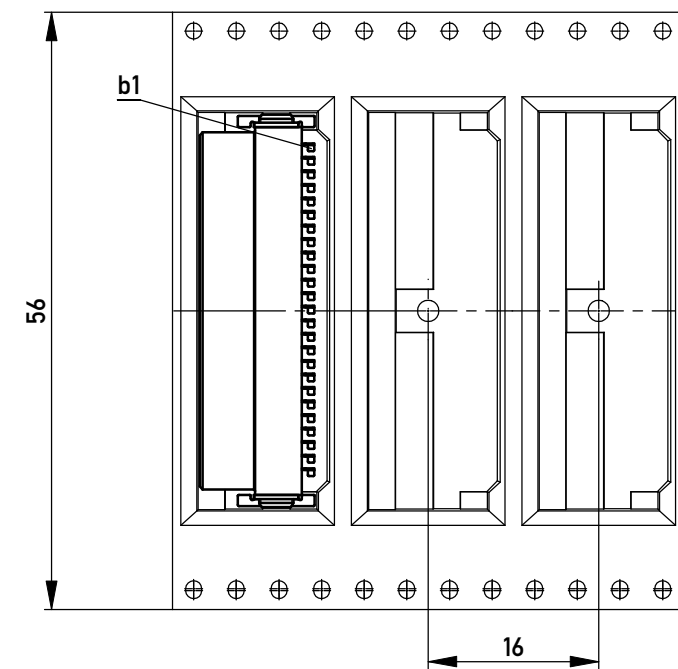

BA7-03 - Standard Bauhöhe  
type7-03 - Standard Assembly Height

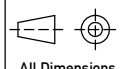
Information:  All rights reserved. Only for Information. To ensure that this is the latest version of this drawing, please contact one of the ERNI companies before using.	Tolerances  All Dimensions in mm	Scale 3:1
	Designation <b>Federl. SMC-Q 50-SMD-BA7-03</b> <b>Female SMC-Q 50-SMD-type7-03</b>	
www.ERNI.com	154742	
f Index	07.10.2010 Date	Class SMCQ

Copyright by ERNI GmbH  
Proprietary notice pursuant to ISO 16016 to be observed.

1  
A3