



ODU MINI-SNAP PC: The Connector with Push-Pull-Locking in Plastic

Cylindrical Connectors are generally available with several locking mechanisms:

The most frequently used are:

- Threaded-Locking Sleeve
- Bayonet-Locking
- Push-Pull-Locking

Push-Pull-Connectors have a very simple locking mechanism:

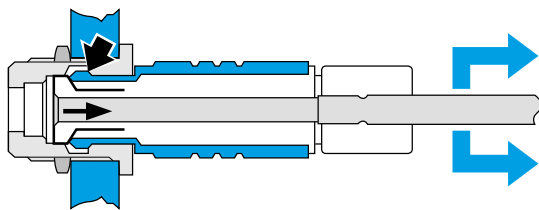

Pulling on the cable or on the back nut causes the locking fingers to grip tighter into the groove inside receptacle. A separation is virtually impossible.

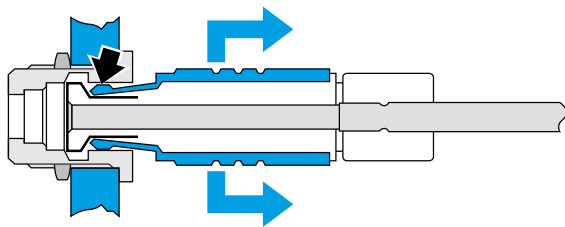

Pulling on the outer plug housing disengages the locking fingers from the receptacle groove and the connector separates easily.

The Advantages of Push-Pull-Connectors:

- Quick and easy mating and demating
- Easy blind mating in difficult to-reach places
- Less panel space required
- Definite and secure locking condition
- Less mating required

Applications



Medical

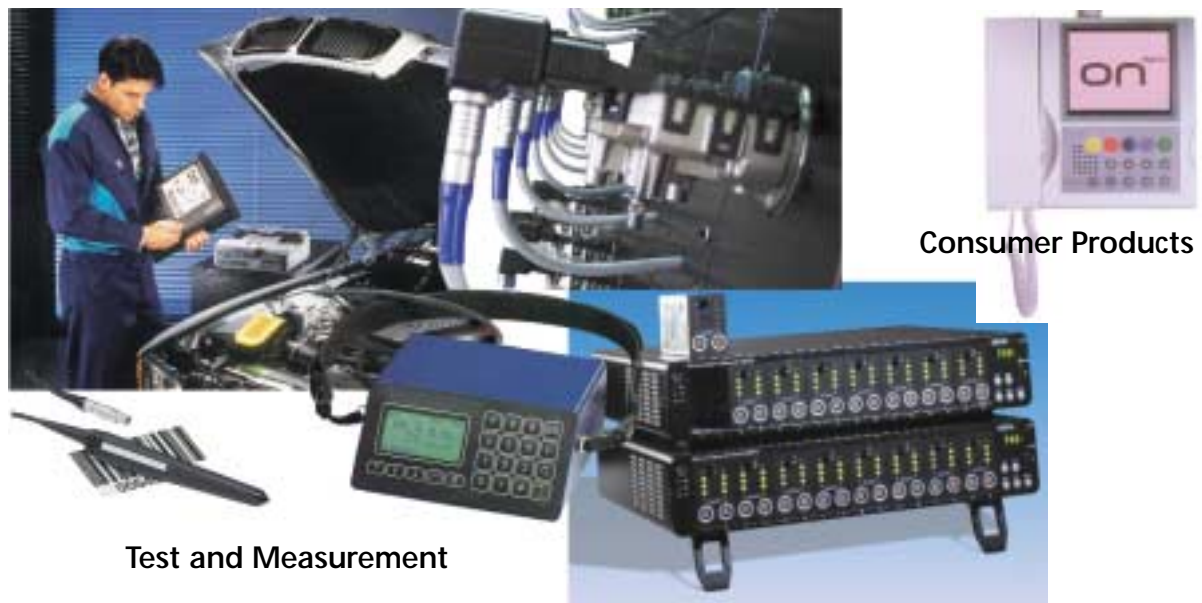

Consumer Products

Test and Measurement



Commercial Electronic

Industrial Electronic



Important Issues At A Glance:

- The series is certificated for  and VDE.
- **Connector with plastic housing available in 3 sizes**
Outside diameter between 12,5 mm and 19 mm
Number of contact positions: 2 to 27 position
- **With solder-, crimp and print termination available**
- **Operation temperature: - 40 °C - + 120 °C**
- **Compatible to ODU MINI-SNAP Series F & Fischer Connectors Holding S.A.**
(Must be checked)
- **5000 Mating Cycles with all contact types**
- **High Economy:**
 - Automatic crimping
 - Easy mounting of the contacts
 - Easy mounting from the connector
 - Economic solutions
- **Further Advantages:**
 - 100 % touch protection
 - Low weight
 - Low mating forces
 - Non magnetic
 - Autoclavable, chemical resistant
- **Special designs**
 - Watertight version, IP 68
 - Shielded version
 - Disposable = One-Way-Version
 - Autoclavable version

Plug, Style 1, IP 50

Inner parts (sleeve and cable collet in plastic)

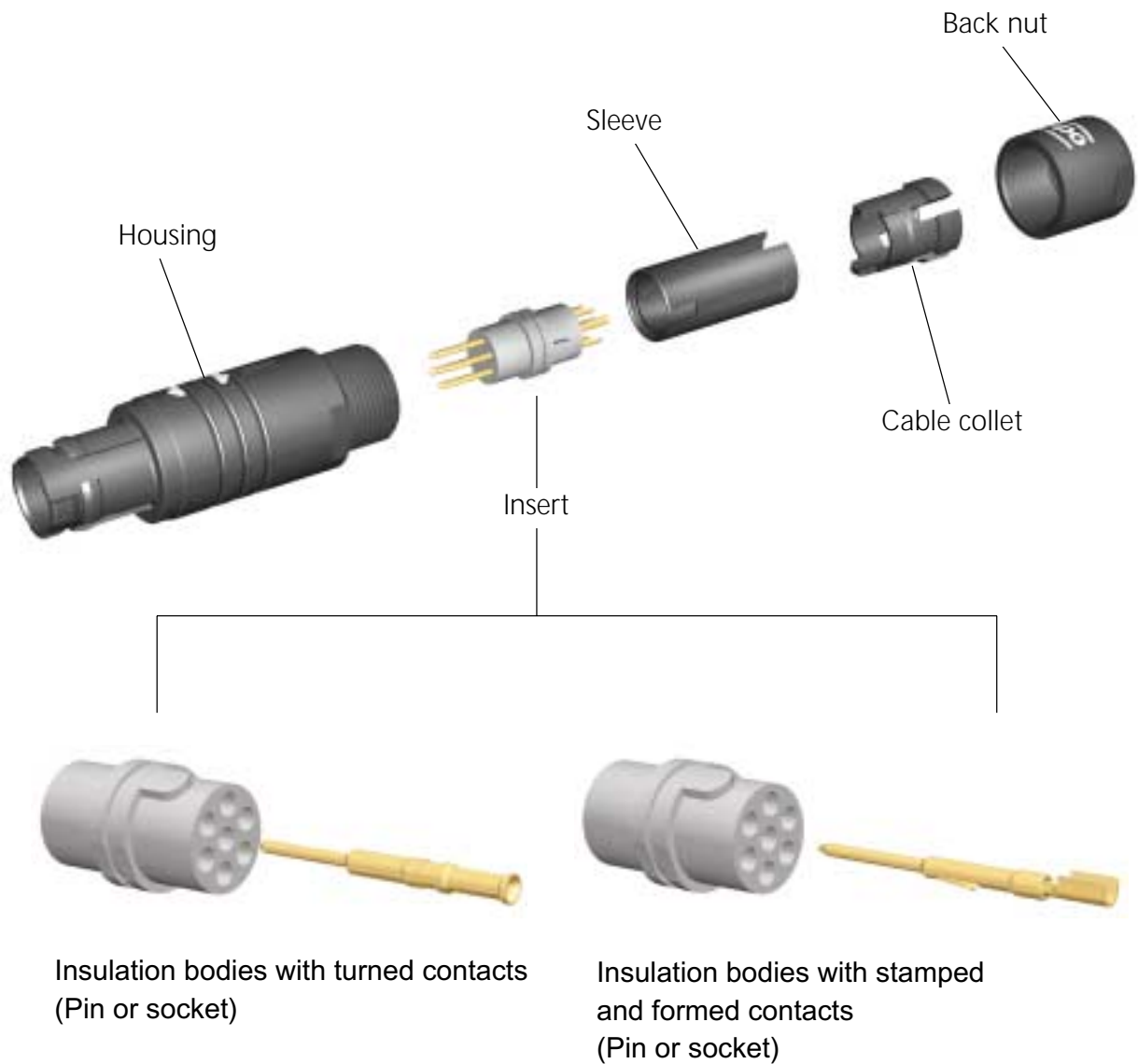

- Easy and fast assembling
- The long housing guiding groove makes blind assembling possible



Receptacle, Style 1, IP 50

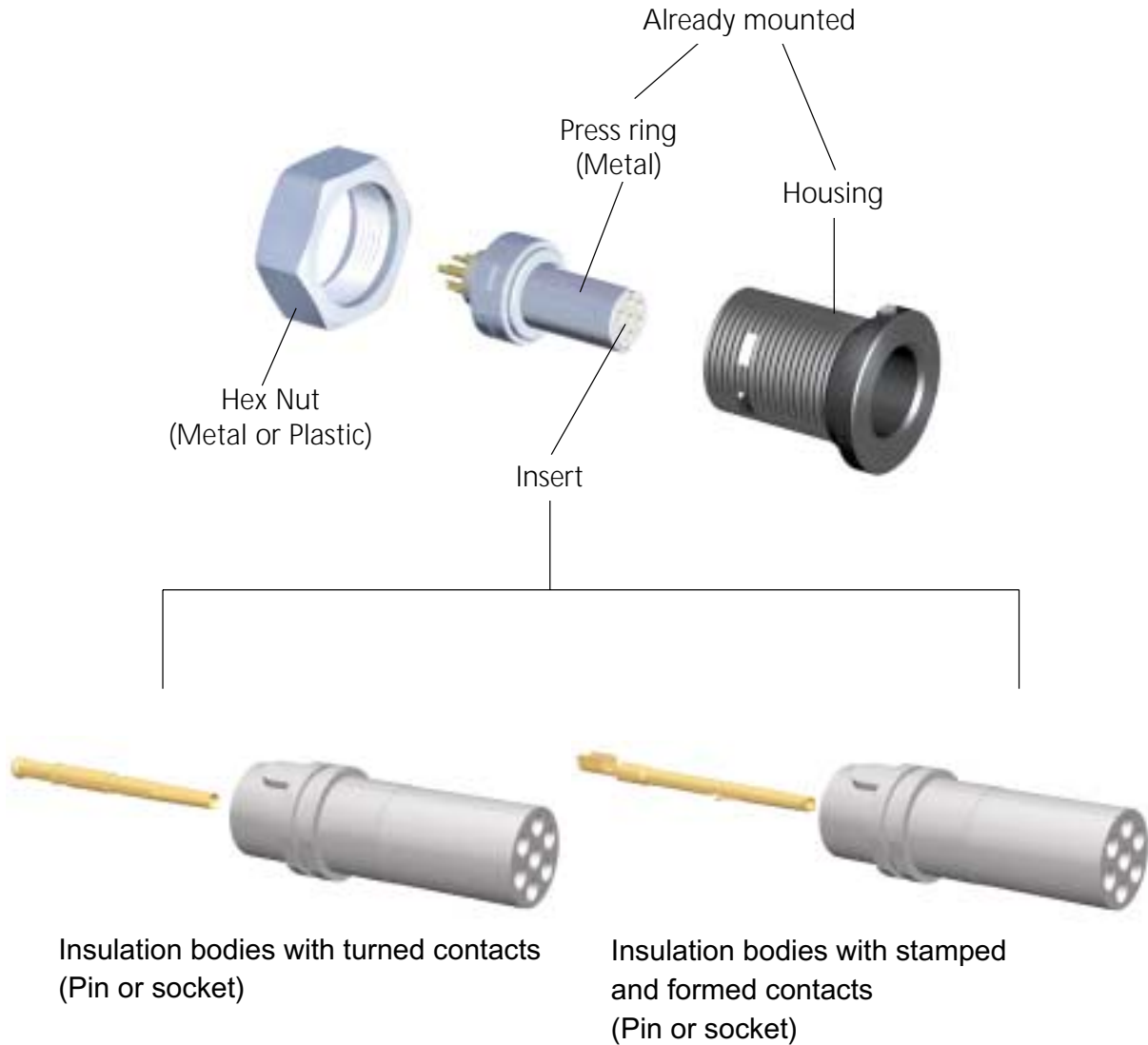

● Other styles see page 29

In-Line Receptacle, Style 1, IP 50

Inner part (cable collet) in plastic

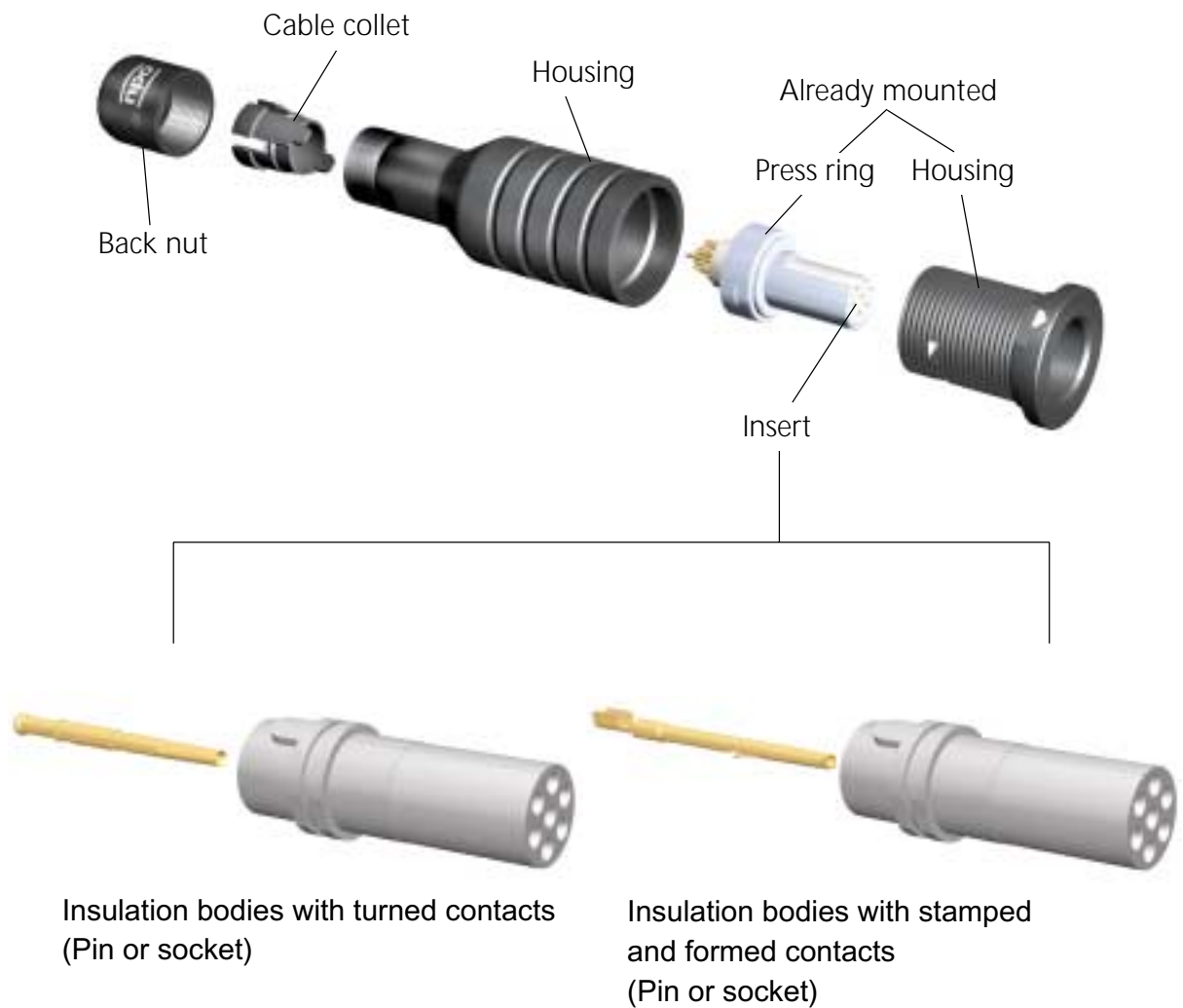

- Easy and fast assembling

Turned contact

Turned contacts are available from the metal version **ODU MINI-SNAP** in the diameters of 0.5 to 2.0 mm.

The contacts are available with following terminations:

- Solder
- Crimp
- PCB

Standard Pin

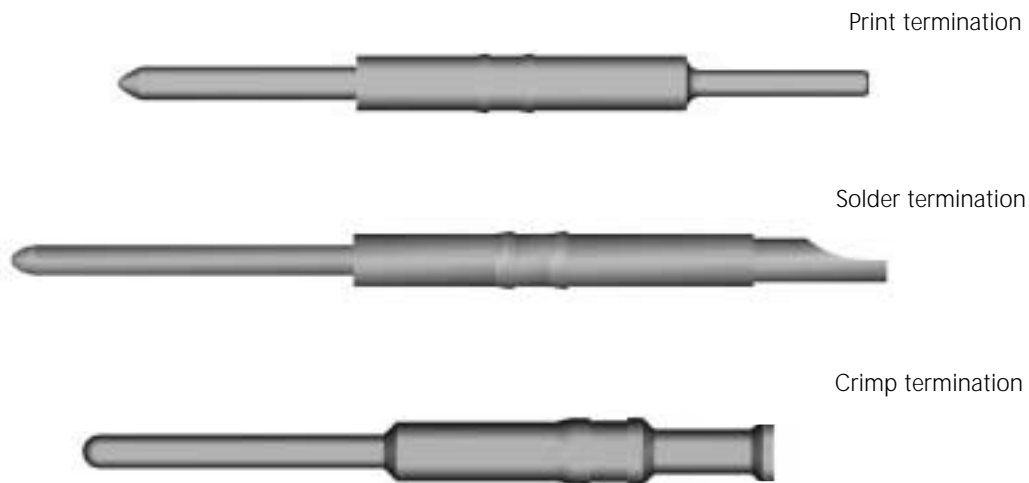

Mating cycles:	> 5000
Material:	Brass
Plating:	At least 1,25 μm Ni; at least 0,75 μm Au

**Informations for diameter, termination styles and current load
please find by the inserts (Page 36)**



Compatibility

ODU MINI-SNAP PC is intermatable with the metal version Series F. A part from this, when choosing the right inserts, the connector is intermatable with products of Fischer Connectors Holding S.A (must be checked).

Inserts

ODU MINI-SNAP PC has been developed on the basis of the metal version [ODU MINI-SNAP](#). **Accordingly a lot of inserts of the series F and series B from the metal version in sizes 1, 2, and 3 can be inserted into the MINI-SNAP PC.** Approx. 100 different contact configurations are available right now.

Watertight version (IP 68)

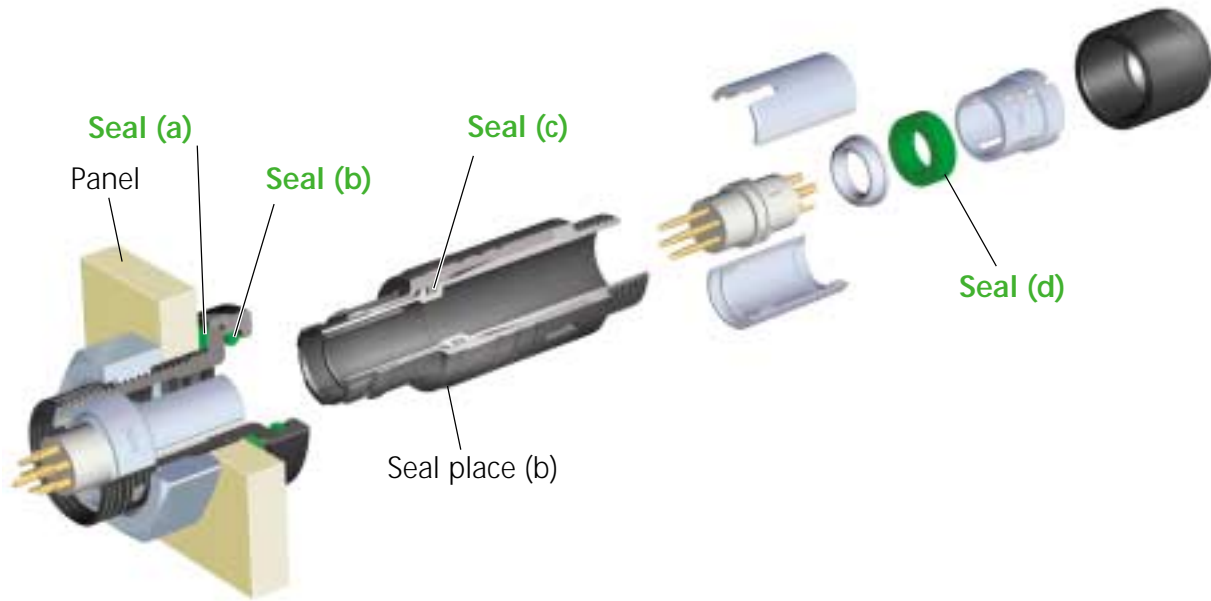

Seal (a): Sealing between the receptacle and the panel

Seal (b): Sealing between the plug and the receptacle

Seal (c): Sealing between the both plug housings

Seal (d): Sealing between the cable and the plug

Receptacle IP 68 (Style E)

- IP 68 in mated condition or with protective cover (see page 63)
- Receptacle is not potted
- For all Types (see page 33)

Plug IP 68 (Style 3 & 4)

- IP 68 in mated condition
- with metall inner parts (Type A/C see page 32)

The watertight version is also shielded available.

Shielded Version with plastic inner parts

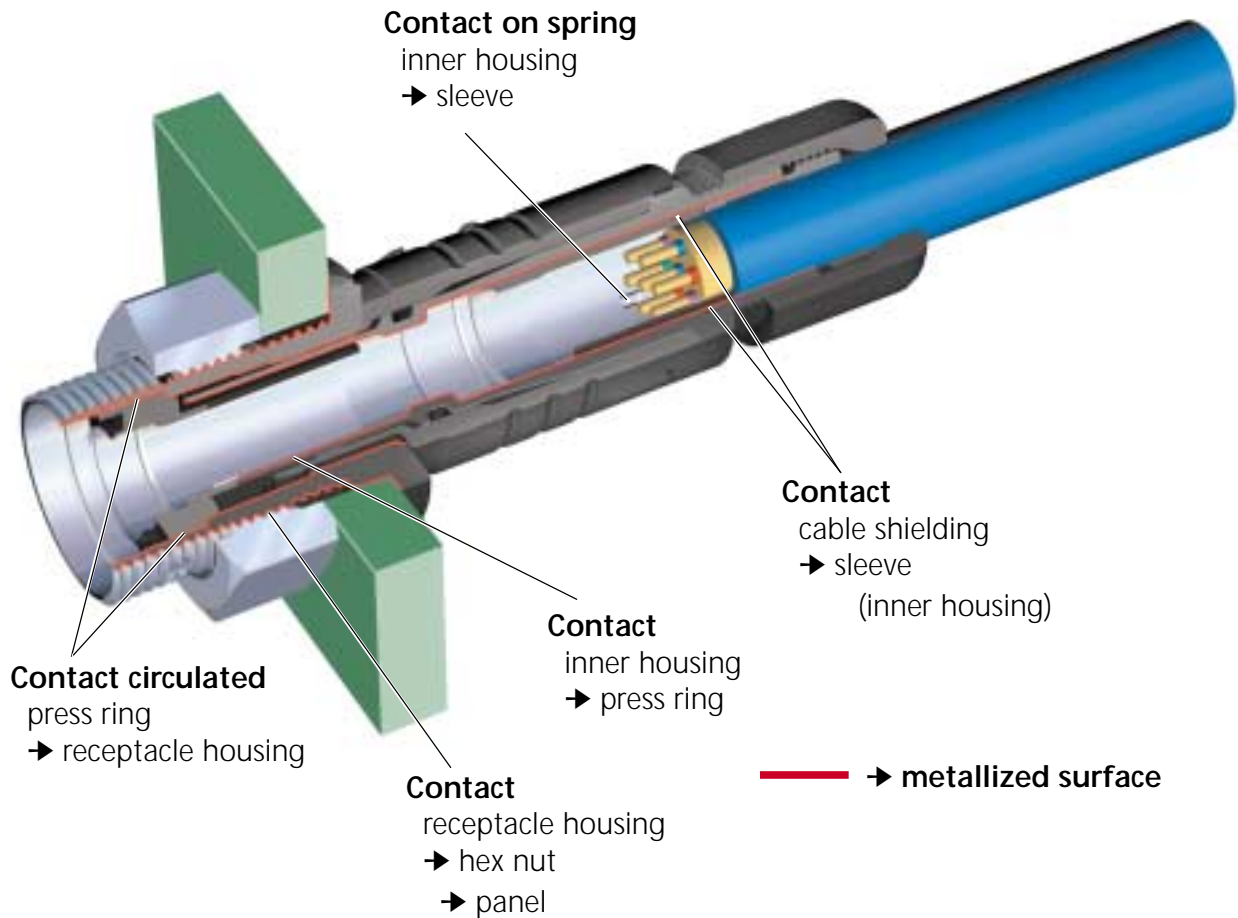

The shielded version is realized by metallizing several components. In spite of the metallizing the connector in mated condition remains 100 % touch proof.

Plating:	5 μm Cu + 2 μm Ni
Mating cycles:	At least 100 Cycles
Contact resistance:	< 20 m Ω
Attenuation:	> 60 dB
Autoclaving cycles:	At least 100 Cycles (DIN EN 13060)

Disposable / One-Way-Version

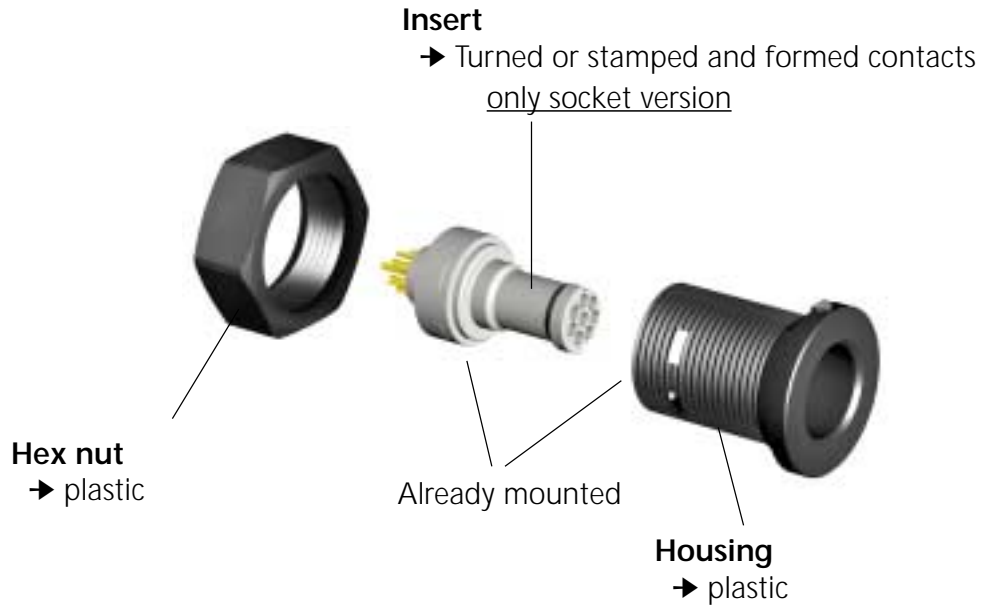

- Custom specific connector (on request)
- Not in shielded version available
- Only with socket insert available

Autoclaving of the insulation bodies

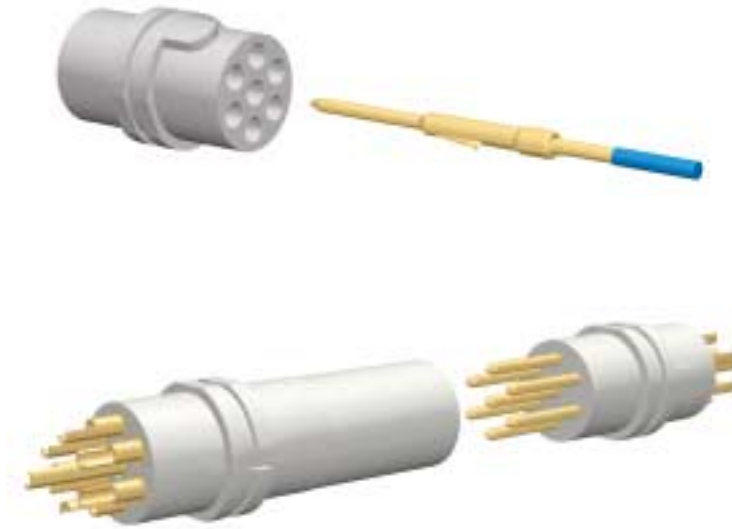

The insulation body materials are **PBT** (Standard) or **PEEK**

- For Autoclaving - connectors we always use PEEK.
(Disposable on request)

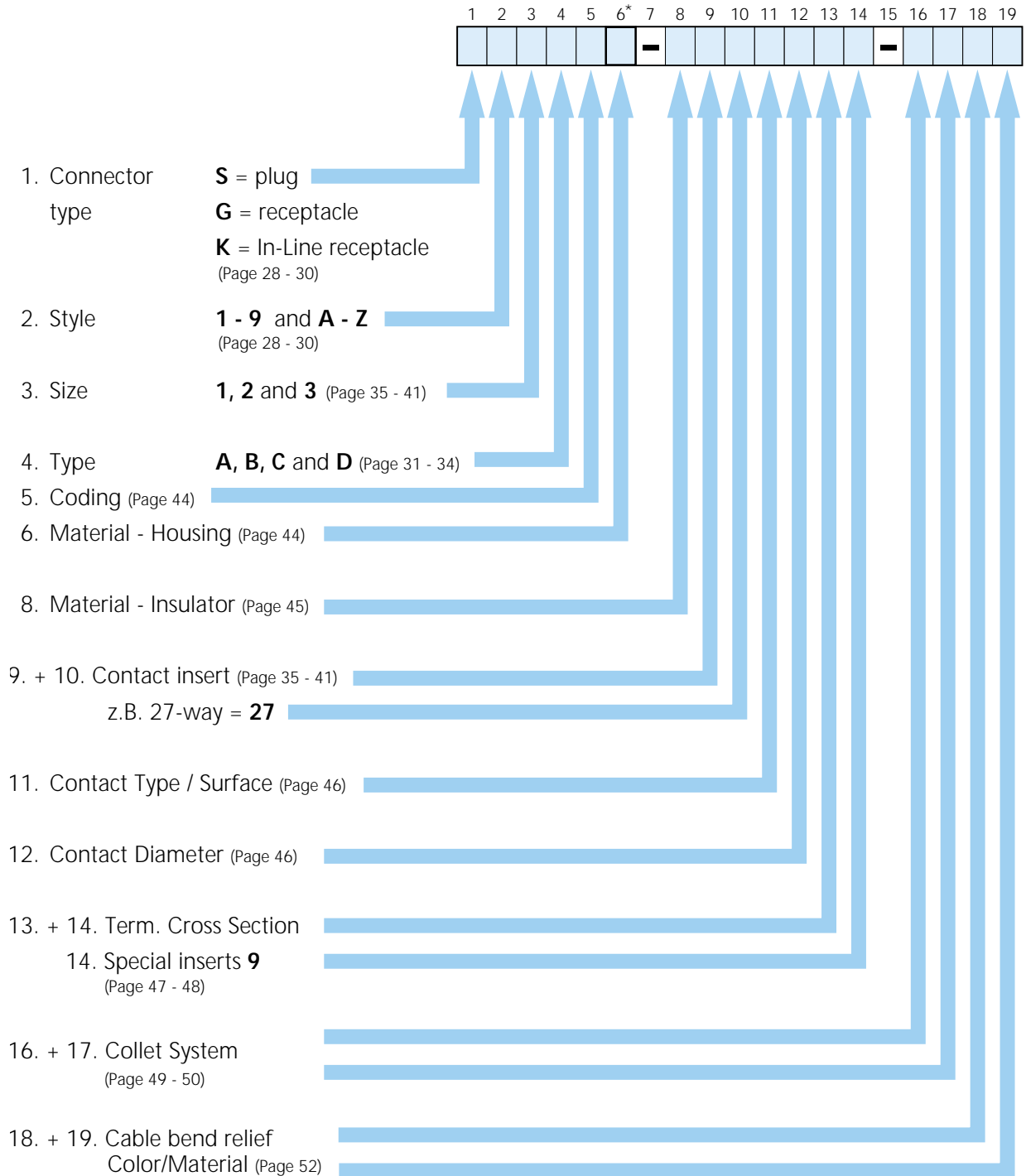

Example:

1	2	3	4	5	6	7	8	9	10	11	12	13	14	15	16	17	18	19
S	4	1	A	1	8	-	T	0	7	4	F	Z	0	-	4	5	G	P

Plug – IP 68 – Size 1 – Type A – Coding 1 – Black plastic housing – PBT insulator – 7-way stamped and formed Crimp-Pin – AWG 28-26 – Cable diam. 4,1-4,5 mm – Black Cable Bend Relief - Material PUR

* If in field number 6 there is a 3 or 8, and in field number 4 there is a A, B, C, or D, it can be seen right away that this product is a Push-Pull Connector of the plastic PC version.

Part Number Key

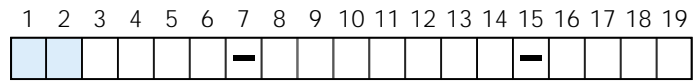

Straight Plug

(Suitable for all following receptacles and In-Line-Receptacles)

- S 1** - IP 50 – With Standard Back Nut
- S 2** - IP 50 – With Back Nut for Cable Bend Relief
- S 3** - IP 68 – Watertight with Standard Back Nut
- S 4** - IP 68 – Watertight with Back Nut for Cable Bend Relief

Contact configuration from page 36



Size	Dimensions in mm				
	L1	L2	D	SW-A	SW-B
1	~ 46	~ 35	12,5	11	11
2	~ 52	~ 39	15	13	13
3	~ 59	~ 45	19	16	17

Part Number Key

1	2	3	4	5	6	7	8	9	10	11	12	13	14	15	16	17	18	19
						-								-				

Receptacle

G 1 Style 1 – ODU MINI-SNAP PC receptacle IP50, installation from front of panel

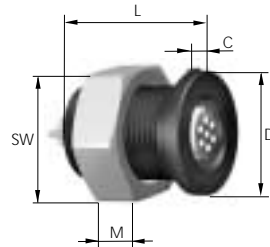

Technical Data

- IP 50
- anti-rotation feature
- contact configuration from page 36
- min. wall-thickness 1 mm

Size	Dimensions in mm					 Panel Cut-Out
	L	D	C	M	SW	
1	18,5	16,5	2,0	5,5	16,0	SW 12,6 / Ø 13,6
2	20,5	21,0	2,0	5,5	19,0	SW 15,6 / Ø 16,6
3	25,0	24,5	2,0	5,5	24,0	SW 19,1 / Ø 21,1

G 5 Style 5 – ODU MINI-SNAP PC receptacle IP50, continuous thread, installation from rear or front of panel. Front extension adjustable.

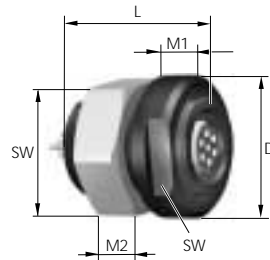

Technical Data

- IP 50
- anti-rotation feature
- contact configuration from page 36

Size	Dimensions in mm					 Panel Cut-Out
	L	D	M1	M2	SW	
1	18,5	19,0	5,0	5,5	16,0	SW 12,6 / Ø 13,6
2	20,5	21,5	5,0	5,5	19,0	SW 15,6 / Ø 16,6
3	25,0	28,0	5,0	5,5	24,0	SW 19,1 / Ø 21,1

G E Style E – ODU MINI-SNAP PC receptacle IP 68, installation from front of panel.

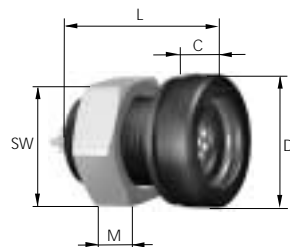

Technical Data

- IP 68
- contact configuration from page 36

Size	Dimensions in mm					 Panel Cut-Out
	L	D	C	M	SW	
1	22,0	18,5	-6,0	5,5	16,0	SW 12,6 / Ø 13,6
2	24,0	22,5	-6,0	5,5	19,0	SW 15,6 / Ø 16,6
3	28,5	26,5	-6,0	5,5	24,0	SW 19,1 / Ø 21,1

Part Number Key

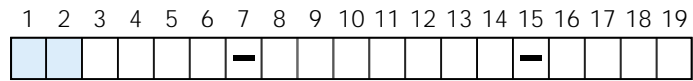

In-Line Receptacle

- K 1** - IP 50 – With Standard Back Nut
- K 2** - IP 50 – With Back Nut for Cable Bend Relief

Contact configuration from page 36

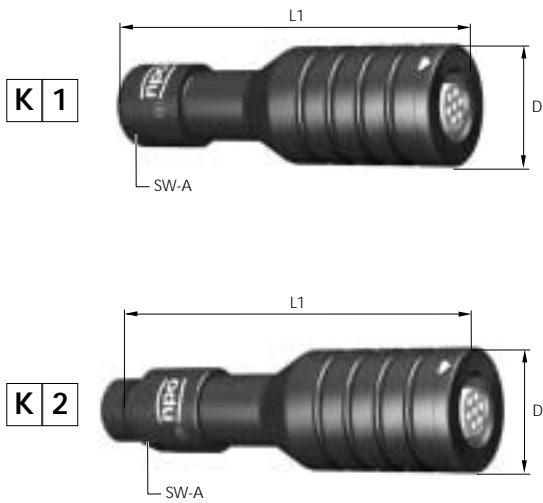

Size	Dimensions in mm		
	L1	D	SW-A
1	52,0	16,5	11,0
2	57,0	21,0	13,0
3	64,0	25,0	16,0

ODU MINI-SNAP PC In-Line Receptacle connect to plug for cable-to-cable connection.

For assembly use adhesive Scotch Weld DP 190 (ODU Number: 890 204 000 030 025) for thread locking of the housings.

Size 1, turned contacts

Part Number Key

1	2	3	4	5	6	7	8	9	10	11	12	13	14	15	16	17	18	19
		1				-							*	-				

	Size	Positions		Contact Ø mm (Termination cross section see page 47)	Rated current (A) (Derating factor see page 54)	Test voltage acc. VDE 0627:1986-06 (kVrms)	Test voltage acc. SAE AS13441:1998 method 3001.1 (kVrms)	Rated voltage acc. SAE AS13441:1998 method 3001.1 (kVrms) ¹⁾	Terminations (Surface see page 81)			View on to termination area	
									Solder	Crimp (Tools for assembly see page 66)	PCB (PCB layout and pin length on request)	Pin Part	Socket part
Standard Contact Configuration <small>compatible with other manufacturers</small>	1	0	2	1,3	14	1,250	1,650	0,550	●	●	●		
	1	0	3	1,3	14	1,000	1,500	0,500	●	●	●		
	1	0	4	0,9	10	1,000	1,500	0,500	●	●	●		
	1	0	5	0,9	10	0,875	1,350	0,450	●	●	●		
	1	0	6	0,7	7	0,875	1,300	0,433	●	●	●		
	1	0	7	0,7	7	0,875	1,300	0,433	●	●	●		
	1	1	2	0,5	5	0,875	1,200	0,400	●	●			
Special Contact Configuration <small>not compatible with other manufacturers</small>	1	0	8	0,7	7	0,875	1,000	0,333	●	●	●		
	1	1	0	0,5	5	0,875	1,000	0,333	●	●			
	1	1	4	0,5	5	1,000	0,900	0,300	●	●			







* If you use a standard contact configuration, so please insert a "0".
If you use a special contact configuration, so please insert a "9".

1) Rated voltage acc. SAE AS 13441:1998 method 3001.1 corresponded MIL-STD 1344, method 3001, test acc. IEC 60512 test 4a. calculation method, caution and suggestion see page 80

Size 1, stamped and formed contacts

Part Number Key

1	2	3	4	5	6	7	8	9	10	11	12	13	14	15	16	17	18	19
		1				-							*	-				

	Size	Positions		Contact Ø mm (Termination cross section see page 48)	Rated current (A) (Derating factor see page 54)	Test voltage acc. VDE 0627:1986-06 (kVrms)	Test voltage acc. SAE AS13441:1998 method 3001.1 (kVrms)	Rated voltage acc. SAE AS13441:1998 method 3001.1 (kVrms) ¹⁾	Terminations (Surface see page 81)			View on to termination area	
									Solder	Crimp (tools for assembly see page 66)	PCB only socket (PCB layout and pin length on request)	Pin Part	Socket part
Standard ^{1*}	1	0	6	0,7	4	0,750	1,300	0,433	●	●	●		
	1	0	7	0,7	4	0,750	1,300	0,433	●	●	●		
Special ^{2*}	1	0	8	0,7	4	0,750	1,000	0,333	●	●	●		

^{1*} = Standard Contact Configuration
compatible with other manufacturers

^{2*} = Special Contact Configuration
not compatible with other manufacturers

* If you use a standard contact configuration, so please insert a "0".
If you use a special contact configuration, so please insert a "9".

1) Rated voltage acc. SAE AS 13441:1998 method 3001.1 corresponded MIL-STD 1344, method 3001, test acc. IEC 60512 test 4a. calculation method, caution and suggestion see page 80

2) The stamped crimp contacts are only with PEEK insulator available

Size 2, turned contacts

Part Number Key

1	2	3	4	5	6	7	8	9	10	11	12	13	14	15	16	17	18	19
	2					-							*	-				

* If you use a standard contact configuration, so please insert a "0".
 If you use a special contact configuration, so please insert a "9".







	Size	Positions		Contact Ø mm (Termination cross section see page 47)	Rated current (A) (Derating factor see page 54)	Test voltage acc. VDE 0627:1986-06 (kVrms)	Test voltage acc. SAE AS13441:1998 method 3001.1 (kVrms)	Rated voltage acc. SAE AS13441:1998 method 3001.1 (kVrms) ¹⁾	Terminations (Surface see page 81)			View on to termination area	
									Solder	Crimp (Tools for assembly see page 66)	PCB (PCB layout and pin length on request)	Pin Part	Socket part
Standard Contact Configuration <small>compatible with other manufacturers</small>	2	0	6	0,9	10	1,250	2,100	0,700	●	●	●		
	2	1	1	0,9	10	1,000	1,500	0,500	●	●	●		
	2	1	6	0,7	7	1,000	1,500	0,500	●	●	●		
	2	1	9	0,7	7	0,875	1,200	0,400	●	●	●		
Special Contact Configuration <small>not compatible with other manufacturers</small>	2	0	3	1,6	17	1,500	2,400	0,800	●	●	●		
	2	0	6	1,3	14	1,250	1,500	0,500	●	●	●		
	2	0	8	0,9	10	1,250	1,500	0,500	●	●	●		
	2	1	0	0,9	10	1,250	1,500	0,500	●	●	●		
	2	1	2	0,7	7	1,000	1,350	0,450	●	●	●		

1) Rated voltage acc. SAE AS 13441:1998 method 3001.1 corresponded MIL-STD 1344, method 3001, test acc. IEC 60512 test 4a. calculation method, caution and suggestion see page 80

Size 2, stamped and formed contacts

Part Number Key

1	2	3	4	5	6	7	8	9	10	11	12	13	14	15	16	17	18	19
	2					-							*	-				

	Size	Positions		Contact Ø mm (termination cross section see page 47)	Rated current (A) (Derating factor see page 48)	Test voltage acc. VDE 0627:1986-06 (kVrms)	Test voltage acc. SAE AS13441:1998 method 3001.1 (kVrms)	Rated voltage acc. SAE AS13441:1998 method 3001.1 (kVrms) ¹⁾	Terminations (Surface see page 82)			View on to termination area	
									Solder	Crimp (tools for assembly see page 66)	PCB (ONLY SOCKETS) ²⁾ (PCB layout and pin length on request)	Pin Part	Socket part
Standard ¹⁾	2	1	6	0,7	4	0,750	1,500	0,500	●	●	●		
Special ²⁾	2	1	2	0,7	4	0,750	1,350	0,450	●	●	●		
	2	1	4	0,7	4	0,750	1,200	0,400	●	●	●		

¹⁾ = Standard Contact Configuration
compatible with other manufacturers

²⁾ = Special Contact Configuration
not compatible with other manufacturers

* If you use a standard contact configuration, so please insert a "0".
If you use a special contact configuration, so please insert a "9".

1) Rated voltage acc. SAE AS 13441:1998 method 3001.1 corresponded MIL-STD 1344, method 3001, test acc. IEC 60512 test 4a. calculation method, caution and suggestion see page 80

2) The stamped crimp contacts are only with PEEK insulator available

Size 3, turned contacts

Part Number Key

1	2	3	4	5	6	7	8	9	10	11	12	13	14	15	16	17	18	19
		3				-							*	-				

* If you use a standard contact configuration, so please insert a "0".
 If you use a special contact configuration, so please insert a "9".





	Size	Positions		Contact Ø mm (Termination cross section see page 47)	Rated current (A) (Derating factor see page 54)	Test voltage acc. VDE 0627:1986-06 (kVrms)	Test voltage acc. SAE AS13441:1998 method 3001.1 (kVrms)	Rated voltage acc. SAE AS13441:1998 method 3001.1 (kVrms) ¹⁾	Terminations (Surface see page 81)			View on to termination area	
									Solder	Crimp (Tools for assembly see page 66)	PCB (PCB layout and pin length on request)	Pin Part	Socket part
Standard Contact Configuration <small>compatible with other manufacturers</small>	3	1	5	0,9	10	1,000	1,650	0,550	●	●	●		
	3	2	4	0,7	7	1,000	1,200	0,400	●	●	●		
	3	2	7	0,7	7	1,000	1,200	0,400	●	●	●		
Special Contact Configuration <small>not compatible with other manufacturers</small>	3	0	4	2,0	22	1,500	1,500	0,500	●	●	●		
	3	0	7	1,6	17	1,250	1,800	0,600	●	●	●		
	3	0	8	1,3	14	1,250	1,650	0,550	●	●	●		
	3	1	4	0,9	10	1,250	1,350	0,450	●	●	●		
	3	1	8	0,9	10	1,000	1,350	0,450	●	●	●		
	3	2	0	0,7	7	1,000	1,100	0,366	●	●	●		
	3	2	2	0,7	7	0,875	1,100	0,366	●	●	●		
	3	2	6	0,7	7	0,875	1,000	0,333	●	●	●		

1) Rated voltage acc. SAE AS 13441:1998 method 3001.1 corresponded MIL-STD 1344, method 3001, test acc. IEC 60512 test 4a. calculation method, caution and suggestion see page 80

Size 3, stamped and formed contacts

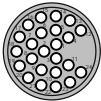
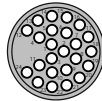
Part Number Key

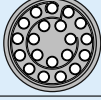
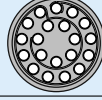
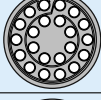
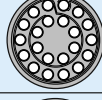
1	2	3	4	5	6	7	8	9	10	11	12	13	14	15	16	17	18	19
		3				-							*	-				

	Size	Positions		Contact Ø mm (Termination cross section: see page 48)	Rated current (A) (Derating factor: see page 54)	Test voltage acc. VDE 0627:1986-06 (kVrms)	Test voltage acc. SAE AS13441:1998 method 3001.1 (kVrms)	Rated voltage acc. SAE AS13441:1998 method 3001.1 (kVrms) ¹⁾	Terminations (Surface: see page 82)			View on to termination area	
									Solder	Crimp (tools for assembly: see page 66)	PCB (only sockets) ²⁾ (PCB layout and pin length on request)	Pin Part	Socket part
Standard ¹⁾	3	2	4	0,7	4	0,750	1,200	0,400	●	●	●		
	3	2	7	0,7	4	0,750	1,200	0,400	●	●	●		
	3	2	0	0,7	4	0,750	1,100	0,366	●	●	●		
Special ²⁾	3	2	2	0,7	4	0,750	1,100	0,366	●	●	●		
	3	2	6	0,7	4	0,750	1,000	0,333	●				

¹⁾ = Standard Contact Configuration
compatible with other manufacturers

²⁾ = Special Contact Configuration
not compatible with other manufacturers

* If you use a standard contact configuration, so please insert a "0".
If you use a special contact configuration, so please insert a "9".

1) Rated voltage acc. SAE AS 13441:1998 method 3001.1 corresponded MIL-STD 1344, method 3001, test acc. IEC 60512 test 4a. calculation method, caution and suggestion see page 80

2) The stamped crimp contacts are only with PEEK insulator available

Coding

Part Number Key

1	2	3	4	5	6	7	8	9	10	11	12	13	14	15	16	17	18	19
						-								-				

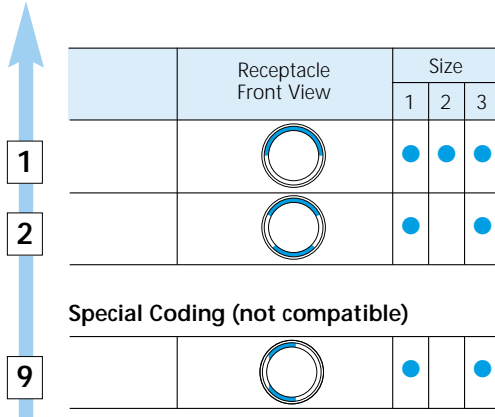

Housing

Part Number Key

1	2	3	4	5	6	7	8	9	10	11	12	13	14	15	16	17	18	19
						-								-				

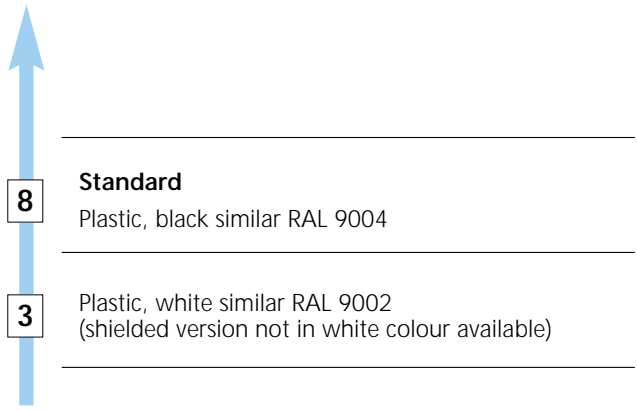

Insulation Body Material

Part Number Key

1	2	3	4	5	6	7	8	9	10	11	12	13	14	15	16	17	18	19
						-								-				



T

PBT

P

PEEK ¹

Turned Contacts

	PBT	PEEK
Solder	✓	✓
Crimp	✓	-
Print	✓	✓

Stamped and Formed Contacts

	PBT	PEEK
Solder	✓	✓
Crimp	-	✓
Print	-	✓

¹) PEEK for receptacle disposable only on request.

Contact Type / Contact Surface - Contact Diameter

Part Number Key

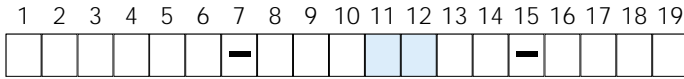

	Type	Surface		Contact Ø	
Turned Contacts	Socket	L - 0,75 µm Au (min.)	L	0,50	Has to mach with selected contact inserts (Page 35)
	Pin	L - 0,75 µm Au (min.)	M	0,70	
	Socket	C - 0,75 µm Au (min.)	N	0,90	
	Pin	C - 0,75 µm Au (min.)	P	mixed	
	Socket	P - 0,75 µm Au (min.)	Q	1,30	
	Pin	P - 0,75 µm Au (min.)	R	1,50	
* Stamped Contacts	Socket	L - 0,75 µm Au (min.)	1	1,60	
	Pin	L - 0,75 µm Au (min.)	2	2,00	
	Socket	C - 0,75 µm Au (min.)	3	3,00	
	Pin	C - 0,75 µm Au (min.)	4	4,00	
	Socket	P - 0,75 µm Au (min.)	5		
					C
					F
					J
					M
					P
					Q
					S
					T
					V
					W

L = Solder termination

C = Crimp termination

P = PCB termination

* = Only with Ø 0,7 mm available

Termination Cross Section for **Turned** Contacts

Part Number Key

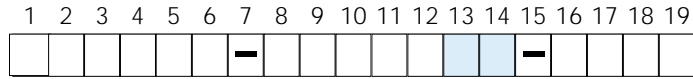

Crimp Contact

Contact Ø	Size	AWG	mm ²
0,7	1	24/26	0,25/0,15
0,7	1	22	0,38
0,9	1	24/26	0,25/0,15
0,9	1	20/22	0,50/0,38
1,3	1	18	1,0
0,7	2	24/26	0,25/0,15
0,7	2	22	0,38
0,9	2	24/26	0,25/0,15
0,9	2	22	0,38
0,9	2	20/22	0,50/0,38
1,3	2	18	1,0
0,7	3	24/26	0,25/0,15
0,7	3	22	0,38
0,7	3	28/30	0,08/0,05
0,9	3	24/26	0,25/0,15
0,9	3	20/22	0,50/0,38
1,3	3	18	1,0
1,6	3	16	-



D	O
G	O
D	O
H	O
L	O
D	O
G	O
D	O
G	O
H	O
L	O
D	O
G	O
C	O
D	O
H	O
L	O
N	O

Tools for crimping and their adjustments see Page 66

Solder Contact

Contact Ø	Term. Ø	Term. Cross	
		AWG	mm ²
0,5	0,4	28	0,08
0,7	0,6	26	0,15
0,9	0,85	22	0,38
1,3	1,1	20	0,50
1,6	1,5	18	1,00
2,0	1,85	14	1,5
2,0	2,4		2,5

C	O
D	O
G	O
H	O
N	O
Q	O
S	O

PCB Contact

Contact Ø	Term. Ø
0,5	0,5
0,7	0,5
0,9	0,7
1,3	0,7
1,6	0,7
2,0	0,7

O	O
O	O
O	O
O	O
O	O
O	O

For mixed inserts

O	O
---	---

(Please provide details of termination cross section!)

Termination Cross Section for Stamped and Formed Contacts

Part Number Key

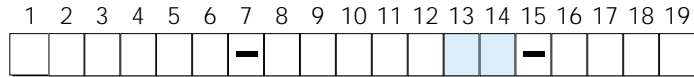

Crimp Contact

Contact Ø	Size	AWG	mm ²
0,7	1	24/22	0,22/0,38
0,7	1	28/26	0,09/0,14
0,7	2	24/22	0,22/0,38
0,7	2	28/26	0,09/0,14
0,7	3	24/22	0,22/0,38
0,7	3	28/26	0,09/0,14

Y	0
Z	0
Y	0
Z	0
Y	0
Z	0

Solder Contact

Contact Ø	Term. Ø	Term. Cross	
		AWG	mm ²
0,7	1,0	22	0,38

G	0
---	---

PCB Contact*

Contact Ø	Term. Ø
0,7	0,7

0	0
---	---

* Only socket insert available

Plastic cable collet for the Types B & D (Page 32 and 34)

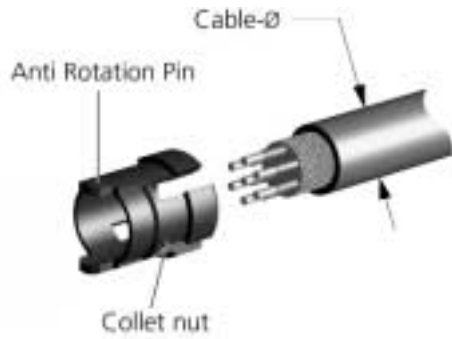

Part Number Key

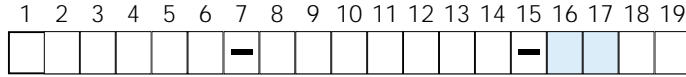

Insert: for all Plugs and In-Line Receptacles of the Types B & D

Application: **Collet Nut** for strain relief.

Cable diameter in mm	Size		
	1	2	3
> 1,5 - 3,0	●		
> 3,1 - 4,5	●	●	
> 4,6 - 6,0	●	●	●
> 6,1 - 7,5		●	●
> 7,6 - 9,0		●	●
> 9,1 - 10,5			●
without collet nut			
with all collet nuts			



Collet System for the Types A & C (Page 32)

Part Number Key

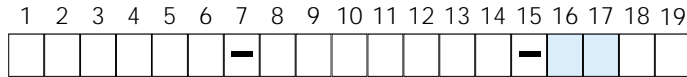
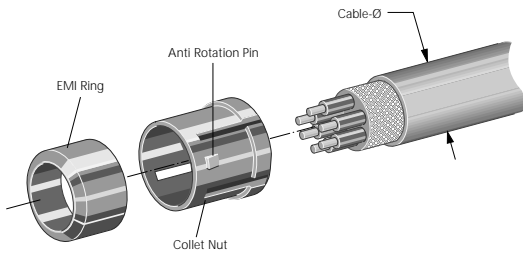

Insert: for all Plugs and In-Line Receptacles of the Types A & C.

Application: **Collet nut** for strain relief, **EMI ring** for conductive path between shield and housing.

Cable diameter in mm	Size		
	1	2	3
> 2,5 - 3,0	●	●	
> 3,0 - 3,5	●	●	●
> 3,5 - 4,0	●	●	●
> 4,0 - 4,5	●	●	●
> 4,5 - 5,0	●	●	●
> 5,0 - 5,5	●	●	●
> 5,5 - 6,0	●	●	●
> 6,0 - 6,5	●	●	●
> 6,5 - 7,0	●	●	●
> 7,0 - 7,5		●	●
> 7,5 - 8,0		●	●
> 8,0 - 8,5		●	●
> 8,5 - 9,0		●	●
> 9,0 - 9,5			●
> 9,5 - 10,0			●
> 10,0 - 10,5			●
> 10,5 - 11,0			●
without collet system			



Right-angled PCB-contacts for the Receptacle

Part Number Key

1	2	3	4	5	6	7	8	9	10	11	12	13	14	15	16	17	18	19
G	5					-								-				

Right-angled PCB-contacts



Only in **style 5** available.
Style 1 and E on request.

For the Panel cut-out and
the PCB-layout please
ask for a data sheet.

Cable Bend Relief

(see page 62)

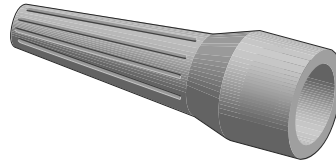

Part Number Key

1	2	3	4	5	6	7	8	9	10	11	12	13	14	15	16	17	18	19
						-								-				

Color of the Cable Bend Relief

Color / RAL-Number <small>(similar)</small>	
red	RAL 3020
white	RAL 9010
yellow	RAL 1016
green	RAL 6029
blue	RAL 5002
grey	RAL 7005
black	RAL 9005
orange	RAL 2004
purple	RAL 4005
brown	RAL 8016
light green	RAL 6018
light blue	RAL 5012
Material	
PUR	
without cable bend relief	



Temperature range
 PUR -40 °C up to +80 °C
 Short-term up to +120 °C

Current Load - Turned Contacts

Nominal Single Contact Current Load for pin / slotted socket

(Nominal Diameter 0.5 mm - 1.6 mm)

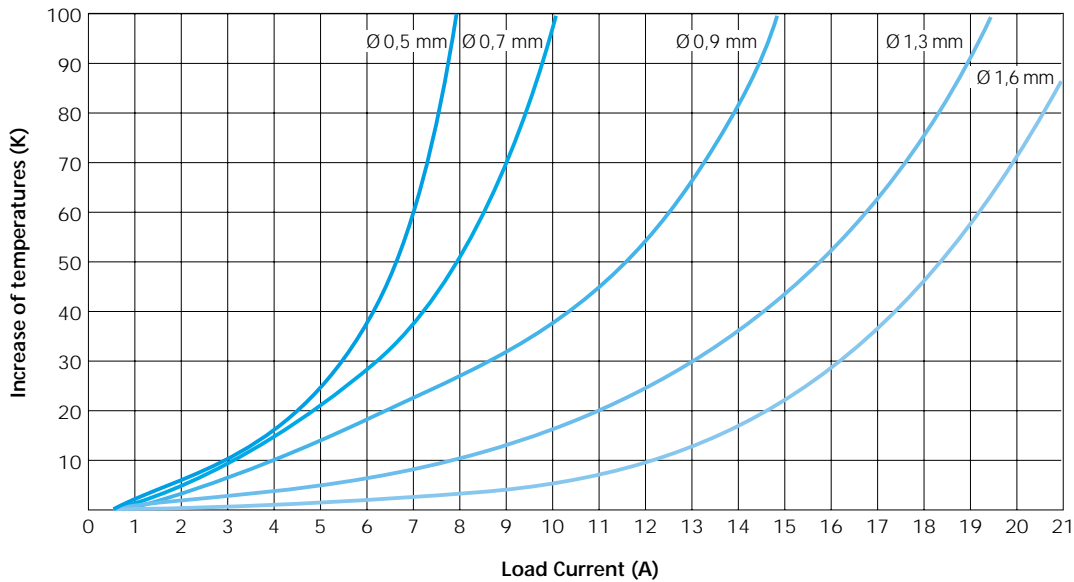

→ **Upper Maximum Temperature for Standard Contacts:** + 120 °C

Test contact was terminated to largest possible conductor.

Connectors or cables with more than one contact or conductor generate a higher temperature than a single contact. Therefore, a **Derating Factor** must be applied. For connectors the Derating Factor is applied according to DIN 57 298 part 2 / VDE 0298 part 2. The Derating Factor is used starting with 5 loaded wires. (DIN 41 640 T 3)

Derating Factor:

Number of loaded wires	Derating Factor
5	0,75
7	0,65
10	0,55
14	0,50
19	0,45
24	0,40

Current Load - Stamped and Formed Contacts

Nominal Single Contact Current Load for pin / slotted socket

(Nominal diameter 0,7 mm)

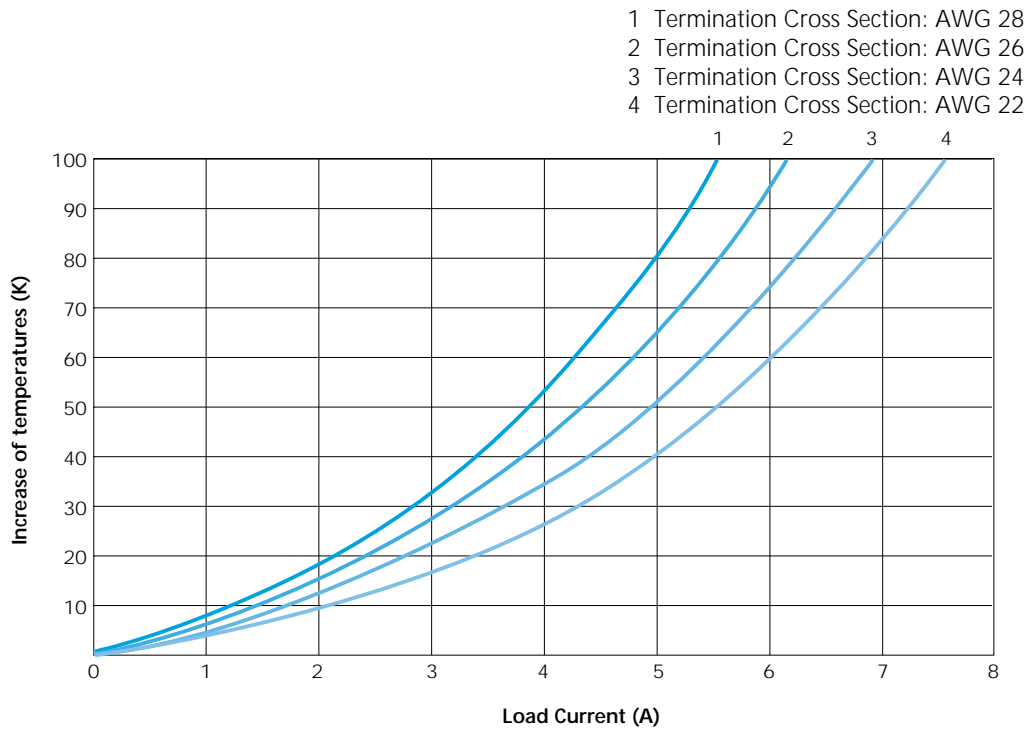

Mating Force: ... ~ 0,35... N

Demating Force: ... ~ 0,33... N

Conclusion: The diagram shows that the connector under a current load of 4 A will reach a temperature of approx. 54 K with connection AWG 28 will reach a temperature of approx. 44 K with connection AWG 26 will reach a temperature of approx. 34 K with connection AWG 24 will reach a temperature of approx. 27 K with connection AWG 22



Housing materials / Surfaces

Component Parts	Material Designation	Surface Thickness of the film
Housing (standard) Back Nut Sleeve	→ PEI (GF) Polyetherimid	-
Housing (shielded)	→ PEI (GF) Polyetherimid	Partial: + 5 µm Cu + 2 µm Ni
Collet (Type B & D)	→ PES Polyethersulfon	-
Collet (Type A & C) EMI-Ring Half-Shells Nut	→ Cu-alloy	→ Ni matt 6-8 µm
Turned Contacts	→ Cu-alloy	→ + 1,25 µm Ni + 0,75 µm Au
Stamped and formed contacts	→ Cu-alloy	→ + 1,25 µm Ni + 0,75 µm Au on the mating area + 3,00 µm Sn on the termination area

Insulation Body Material (UL 94 V-0 rated)

	Norm		Unit	PBT	PEEK
Dialectric Strenght	DIN 53481	ASTM D-149	KV / mm	30	19
Operating Temperature	--	--	°C	- 40 / + 140	-50 / +250
Flammability rating	UL-94	--	--	V-0	V-0
Creeping distance acc. to CTI	IEC 60112		(V)	275	175

Mating Force, Demating Force and Pull-Off-Force

(All details are for the standard housing without insert)

	Size 1	Size 2	Size 3
Mating Force	max. 2,5 N	max. 2,8 N	max. 3 N
Demating Force	max. 2,6 N	max. 2,8 N	max. 3 N
Pull-Off-Force*	min. 80 N	min. 80 N	min.. 85 N

* After an inadvertent pull-out the plug can be used again.

Electromagnetic Compatibility (EMC)

When discussing electromagnetic compatibility (EMC) we need take into account not only the device, circuit etc. but moreover the entire network and communication links and interconnections. This involves all connecting elements such as conductors and connectors. Electromagnetic interference from the outside into the connector can lead to system malfunctioning. The best way to prevent this is by providing a high-quality shield between the cable and the connector. In order to provide reliable EMC data to our customers we engaged the services of a certified test laboratory to investigate the EMC characteristics of the ODU MINI-SNAP PC. They tested for us Size 00, 0, 1, 2 and 3 MINI-SNAP connectors.

Measurements were conducted using the inductive wire or parallel wire method in accordance with test procedure VG 55214-6-2. In this set-up, the mated connector is connected on one end to a network analyzer and terminated on the other end with a suitable impedance. The inductive wire is then mounted in close proximity along the mated connector pair. The induction wire is a ribbon cable which permits to vary the level of induction by using more or less of the ribbon conductors.

Next, a signal with a frequency range of 100 kHz to 2,5 GHz is connected to the ribbon cable. The network analyzer is used to measure the amount of signal induced into the connector circuit. The result is shown as the shielding attenuation A_T in dB. It is essential that all leads to the connector are shielded so that no signal can be induced into the circuit at any other place except the connector. The various attenuation values are plotted on a logarithmic scale as attenuation in dB vs. frequency.

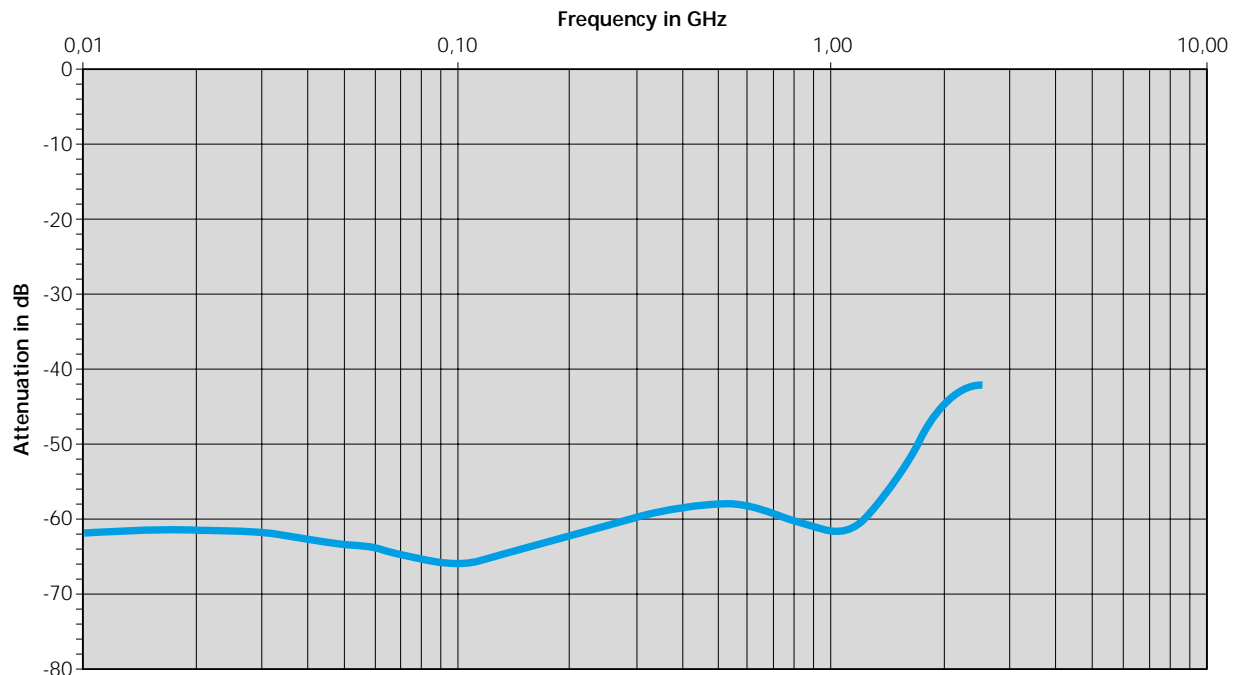
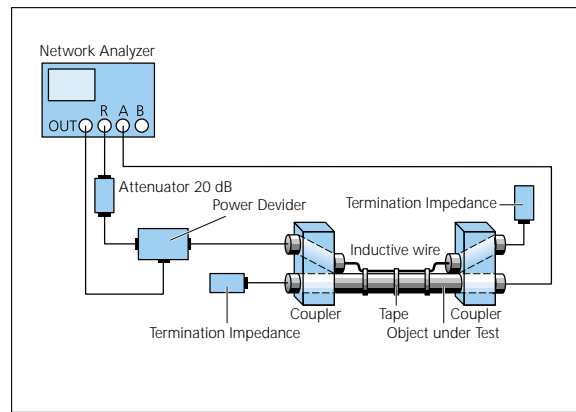

Autoclaving of ODU MINI-SNAP Connectors

If required ODU can deliver MINI-SNAP connectors for the following sterilization process:
 Steam-sterilization with pre-vacuum or gravitation-process. Connectors were tested with autoclave equipment with reference to DIN EN 13 060 at 134° C and 200 cycles.

Sterilization Curve:

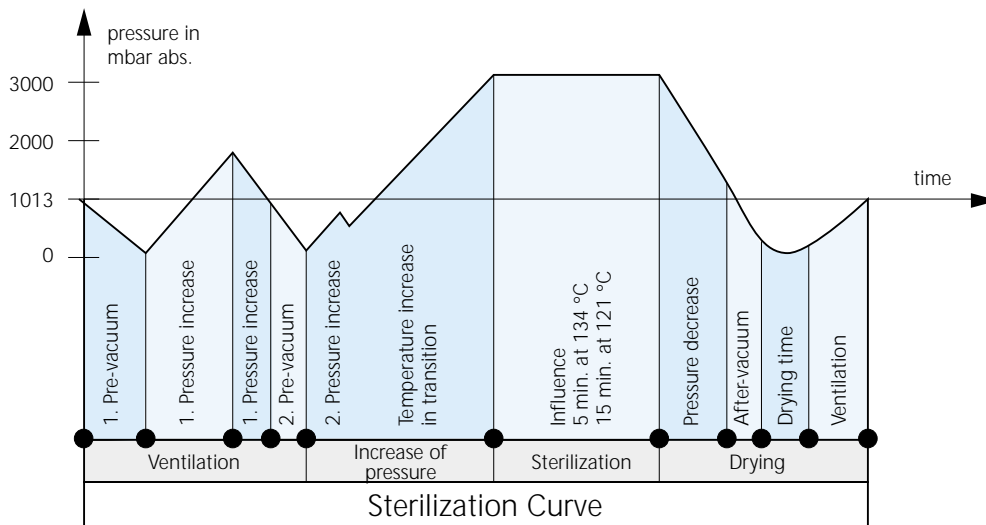

For other sterilization-processes please contact our technical support team.

Back Nut for Cable Bend Relief

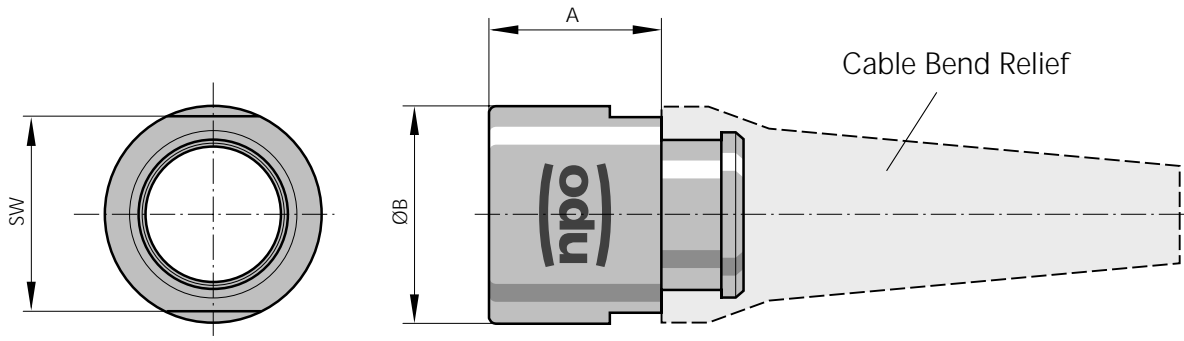

Color	Size	Part Number	Dimensions in mm		
			A	ØB	SW
Black	1	K01 020 113 937 028	10,0	11,0	10,0
	2	K02 020 113 937 028	11,5	14,0	13,0
	3	K03 020 113 937 028	11,5	17,0	15,0
White	1	K01 020 113 937 023	10,0	11,0	10,0
	2	K02 020 113 937 023	11,5	14,0	13,0
	3	K03 020 113 937 023	11,5	17,0	15,0

Cable Bend Relief

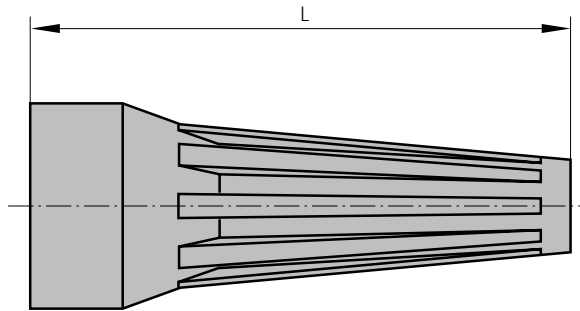

* = In ... please indicate color code

Size	Part Number*	Dim. L	Cable O.D.	
			min.	max.
1	701 022 ... 960 025	30	> 2,5	3,0
1	701 022 ... 960 030	30	> 3,0	3,5
1	701 022 ... 960 035	30	> 3,5	4,0
1	701 022 ... 960 040	30	> 4,0	5,0
1	701 022 ... 960 050	30	> 5,0	6,0
1	701 022 ... 960 060	30	> 6,0	6,5
1	701 022 ... 960 070	30	> 6,5	7,5
2	702 022 ... 960 030	36	> 3,0	3,5
2	702 022 ... 960 035	36	> 3,5	4,0
2	702 022 ... 960 040	36	> 4,0	5,0
2	702 022 ... 960 050	36	> 5,0	6,0
2	702 022 ... 960 060	36	> 6,0	7,0
2	702 022 ... 960 070	36	> 7,0	8,0
2	702 022 ... 960 080	36	> 8,0	9,0
3	703 022 ... 960 040	42	> 4,0	5,0
3	703 022 ... 960 050	42	> 5,0	6,0
3	703 022 ... 960 060	42	> 6,0	7,0
3	703 022 ... 960 070	42	> 7,0	8,0
3	703 022 ... 960 080	42	> 8,0	9,0
3	703 022 ... 960 090	42	> 9,0	10,0

Color code	Color	RAL-No. (similar)
202	red	3020
203	white	9010
204	yellow	1016
205	green	6029
206	blue	5002
207	grey	7005
208	black	9005
209	orange	2004
210	violet	4005
212	brown	8016
215	light green	6018
216	light blue	5012

Temperature range
 PUR -40°C up to +80°C
 Short-term up to +120°C

Protective Cover for IP50 and IP68 (for all receptacle styles)

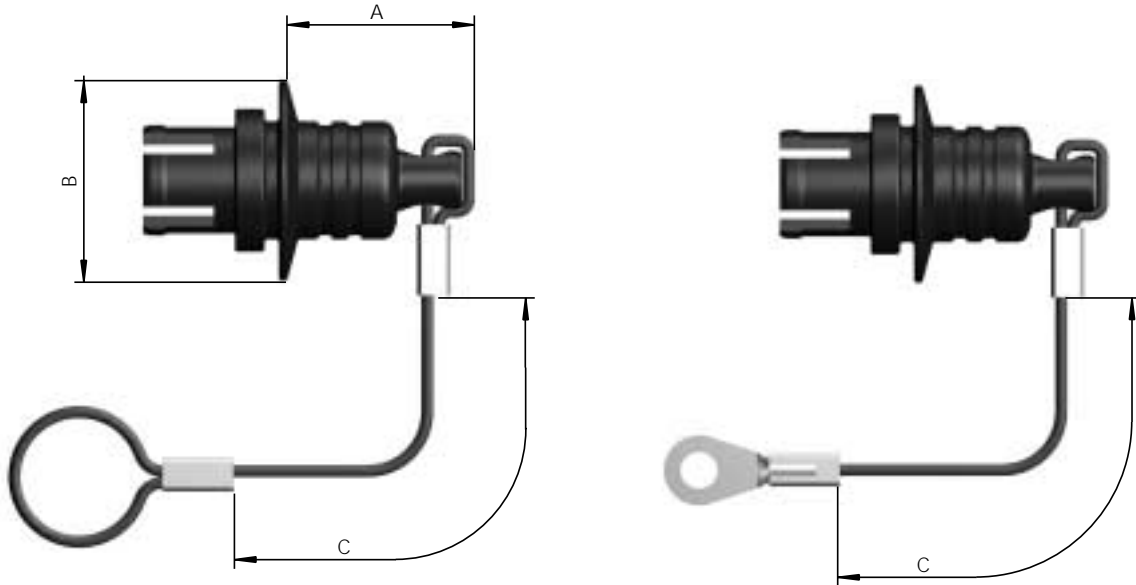

Size	Part Number	Dimensions in mm		
		A	B	C
1	K01 097 006 933 .0.	15,1	17	~75
2	K02 097 006 933 .0.	11,5	14,0	~85
3	K03 097 006 933 .0.	11,5	17,0	~100

With . please, register desired lanyard material
 0 = Polyamid lanyard with loop
 1 = Stainless steel lanyard with loop
 2 = Polyamid lanyard with solder lug
 3 = Stainless steel lanyard with solder lug

With . please, register desired colour of the cap*
 3 = White cap
 8 = Black cap

* = If you use a polyamid lanyard, the colour is corresponding with the colour of the cap.

Spanner Wrench

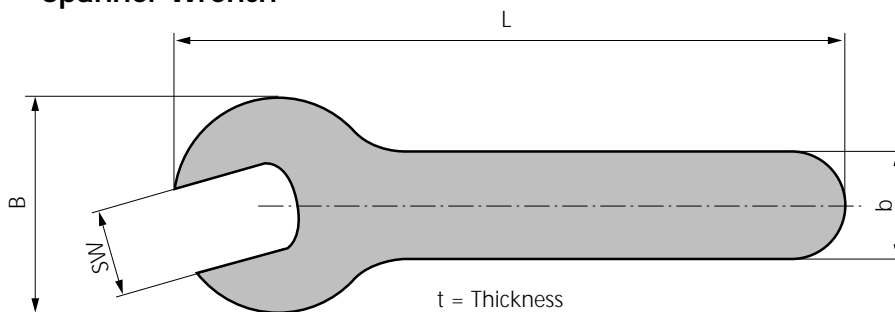

Part number	No.	SW	t	B	L	b
598.700.001.012.000	11	11	2	24,5	115	10
598.700.001.004.000	13	13	2,5	30,5	98	16,5
598.700.001.007.000	16	16	3	35,5	145	15
598.700.001.008.000	17	17	3	35,5	145	15
598.700.001.013.000	19	19	3	40,0	100	18
598.700.001.014.000	24	24	3	54,0	215	22

Assembly Instructions

For plugs with plastic inner parts (IP 50) Type B and D

Screw locking with glue.
Recommended glue:
Scotch Weld DP 190

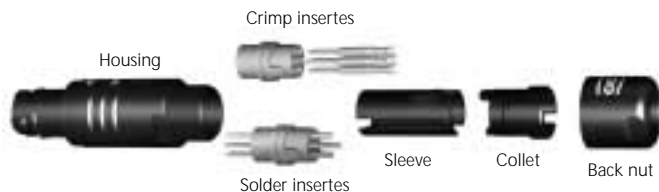

1. Slide back nut, collet and sleeve over the cable.

Crimp termination



2. Strip cable and wire
3. Fit wire into the contact barrel and crimp



4. insert contacts into insulator, use the insertion tool to push them in



Solder termination



2. Strip cable and wire
3. Pre-tinning of strands recommended



4. Solder each wire to the corresponding contact

5. Bend cable shield outwards.



6. Slide the collet against the sleeve and clamp the shield between it.

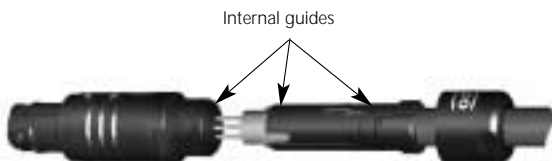

7. Now you can put the assembled cable into the plug-housing.



8. Screw back nut on the plug and fasten cable in the housing. *
Now the plug is assembled.

* ODU Spanner-Wrench: see page 63

Assembly Instructions

For plugs with metal inner parts (IP 68) Type A and C

Screw locking with glue.
Recommended glue:
Scotch Weld DP 190

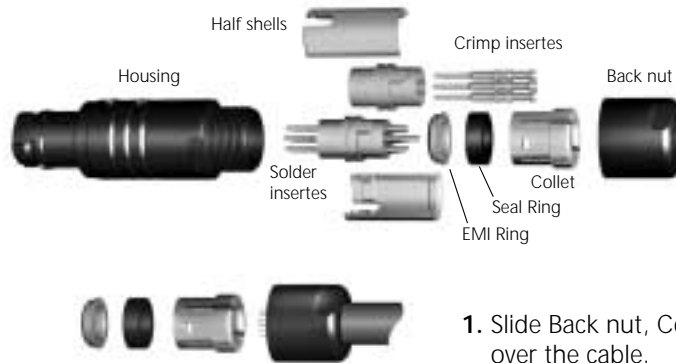

1. Slide Back nut, Collet, Seal Ring and EMI-Ring over the cable.

Crimp termination



2. Strip cable and wire
3. Fit wire into the contact barrel and crimp



4. insert contacts into insulator, use the insertion tool to push them in

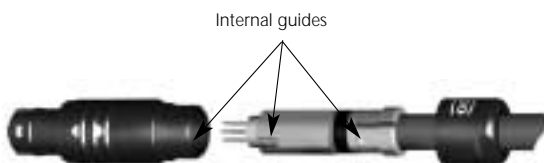

Solder termination



2. Strip cable and wire
3. Pre-tinning of strands recommended



4. Solder each wire to the corresponding contact

5. Bend cable shield outwards.

6. Slide the EMI-Ring against the sleeve and clamp the shield between it.

7. Now you can put the assembled cable into the plug-housing.

8. Screw back nut on the plug and fasten cable in the housing. *
Now the plug is assembled.

* ODU Spanner-Wrench: see page 63

Part Number Key

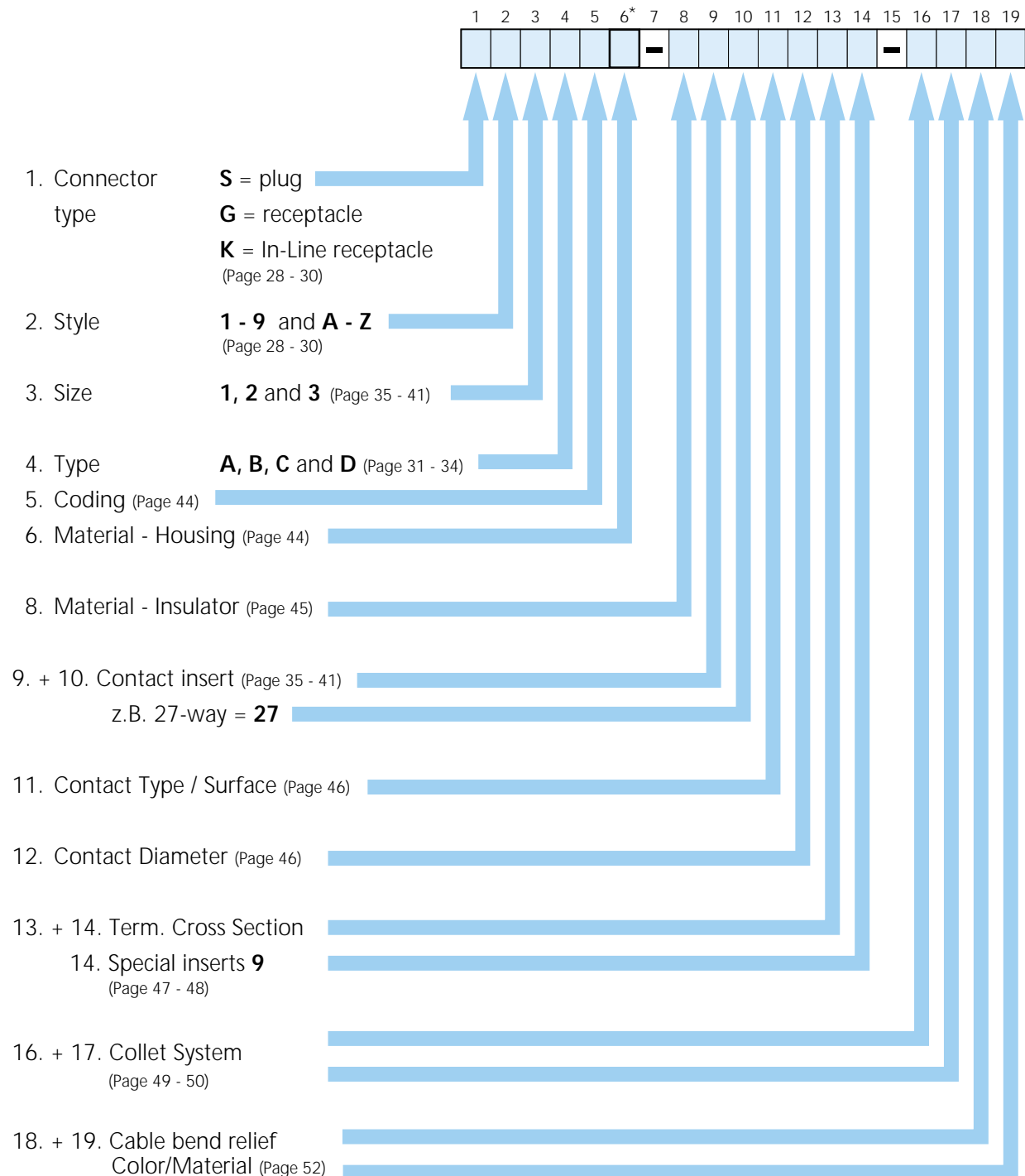

Example:

1	2	3	4	5	6	7	8	9	10	11	12	13	14	15	16	17	18	19
S	4	1	A	1	8	-	T	0	7	4	F	Z	0	-	4	5	G	P

Plug – IP 68 – Size 1 – Type A – Coding 1 – Black plastic housing – PBT insulator – 7-way stamped and formed Crimp-Pin – AWG 28-26 – Cable diam. 4,1-4,5 mm – Black Cable Bend Relief - Material PUR

* If in field number 6 there is a 3 or 8, and in field number 4 there is a A, B, C, or D, it can be seen right away that this product is a Push-Pull Connector of the plastic PC version.