

# LAB & REWORK ACCESSORIES - INSERTION/EXTRACTION TOOLS - PLCC

## PLCC HIGH PERFORMANCE EXTRACTION TOOLS

- For use with PLCC sockets with diagonal extracting slits and pin counts from 20 to 84\*
  - Smooth extracting procedure. The lifting apparatus allows for controlled chip extraction since the jaws retract squarely from the center
  - Counter pressure from the device prevents the chip from tilting during extraction
  - Slim construction allows for use on high density boards
- \* **Note:** With small PLCC's the adjusting screw has to be removed since no counter pressure is necessary

### APPLICATION:

The two steel grip arms fit into the socket's 1.4mm slits, and catch the chip from underneath at the free corners. The tool supports itself on the edges of the socket. When the side arms are squeezed, the lifting apparatus slowly pulls up the arms, releasing the chip.



P/N: TW2200-PLCC

For PLCC tool specifications, pricing and delivery information, please see:  
Web Link: [www.1800adapter.com/051](http://www.1800adapter.com/051)

## PLCC EXTRACTION TOOL

- Use this to extract PLCC packages from their production sockets
- Utilizes the two corners of a production socket available for extracting a PLCC
- Prevents bending or breaking of adjacent leads
- Puller works on PLCC packages with 20, 28, 32, 44, 52, 68, and 84

\*Note: Fits AMP PLCC sockets  
\*\*Note: Fits NEC PLCC sockets.

**Part #**  
P/N-290N  
P/N-290N-SUN\*  
P/N-290N-NEC\*\*

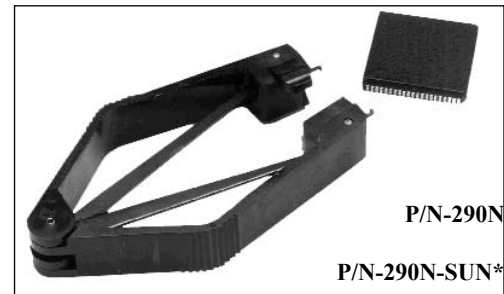
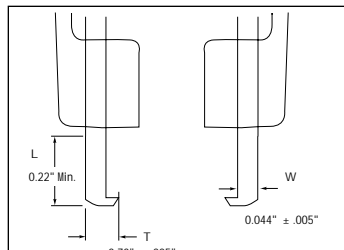

P/N-290N

P/N-290N-SUN\*

For PLCC tool specifications, pricing and delivery information, please see:  
Web Link: [www.1800adapter.com/051](http://www.1800adapter.com/051)

## PLCC VACUUM INSERTION TOOL

- Use this tool to easily insert PLCC packages into their sockets
- Inserter works on PLCC packages with pin counts from 28 to 84
- Conductive plastic material is an active grounding device against static charging

**Part #**  
TW2250-28/44  
TW2250-68/84

P/N: TW2250-68/84



P/N: TW2250-28/44

For PLCC tool specifications, pricing and delivery information, please see:  
Web Link: [www.1800adapter.com/051](http://www.1800adapter.com/051)

## MAGNETIC HANDLING TOOLS

Pocket Telescopic Magnetic Retrieval Tool

- Powerful enough to pick up ferrous metal objects weighing 1 1/2 lbs.
- Extends to 25 9/16 "
- Closes to 5 7/8 "
- Ideal for working with pogo pins and printed circuit board pins!
- Chrome plated

P/N: ET-15X

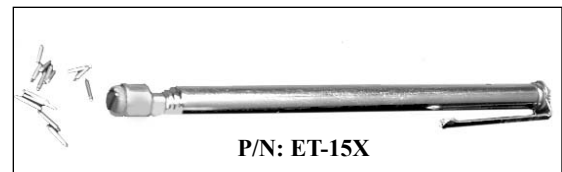

P/N: ET-15X

For information on additional insertion and extraction tools, pricing and delivery information, please see:  
Web Link: [www.1800adapter.com/051](http://www.1800adapter.com/051)

# LAB & REWORK ACCESSORIES - INSERTION/EXTRACTION TOOLS - HGA/PGA

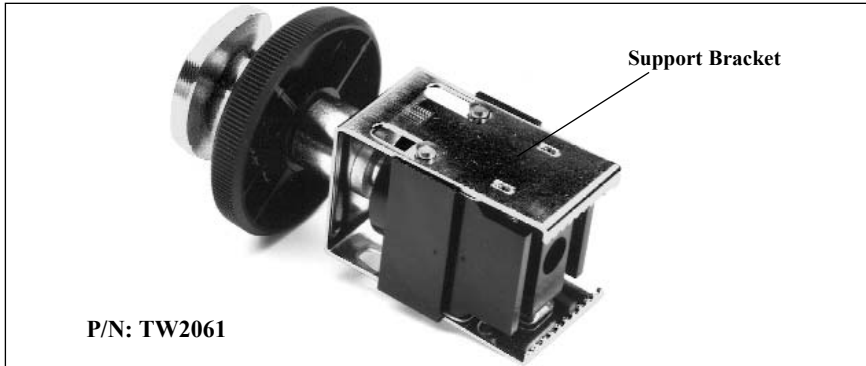

P/N: TW2061

### APPLICATION:

1. The spindle disk is used to adjust the pressure block until it makes contact.
2. The tool is spread open until the gripper plates can hook under the PGA socket.
3. The knurled disk is turned counter-clockwise until the pressure block has pressed the chip down absolutely flat and parallel into the socket, the tool is spread, and removed.

### PGA SINGLE-GRID SIZE INSERTION TOOLS

- For inserting multi-pole HGA/PGA devices into sockets with precision contacts
- Ensures even pressure is applied to the top of the PGA device, preventing tilting and pin damage

### SERIES TW2060 INSERTION TOOLS

Part #	PGA Grid	PGA Package Length
TW2060	10 X 10	26.67mm/1.050"
TW2061	11 X 11	29.21mm/1.150"
TW2062	12 X 12	31.75mm/1.250"
TW2063	13 X 13	34.29mm/1.350"
TW2065	15 X 15	39.37mm/1.550"
TW2066	16 X 16	41.91mm/1.650"
TW2067	17 X 17	44.45mm/1.750"
TW2068	18 X 18	46.99mm/1.850"

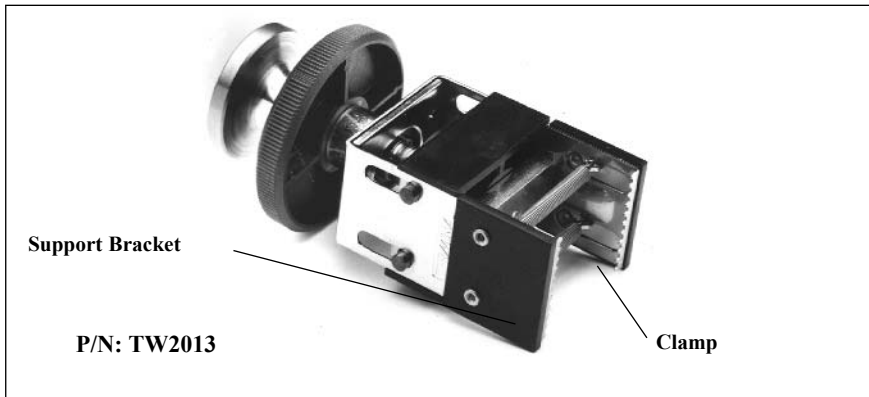

P/N: TW2013

### HGA/PGA SINGLE-GRID SIZE EXTRACTION TOOLS

- For use with PGA devices
- Smooth extracting procedure. The lifting apparatus allows for controlled chip extraction since the jaws retract squarely from the center
- Counter pressure from the device prevents the chip from tilting during extraction
- Plastic sides prevent scratching or damage to wiring even with intense downward pressure

### SERIES TW2010 EXTRACTION TOOLS

Part #	PGA Grid Size	HGA/PGA Package Length	Dimension A		Dimension B	
			Released	Spread	Released	Spread
TW2010	10 X 10	26.67mm/1.050"	.842"	1.039"	1.291"	1.488"
TW2011	11 X 11	29.21mm/1.150"	.940"	1.137"	1.389"	1.586"
TW2012	12 X 12	31.75mm/1.250"	1.043"	1.240"	1.492"	1.688"
TW2013	13 X 13	34.29mm/1.350"	1.141"	1.338"	1.590"	1.787"
TW2014	14 X 14	36.83mm/1.450"	1.240"	1.437"	1.688"	1.885"
TW2015	15 X 15	39.37mm/1.550"	1.342"	1.539"	1.791"	1.988"
TW2016	16 X 16	41.91mm/1.650"	1.444"	1.648"	1.893"	2.090"
TW2017	17 X 17	44.45mm/1.750"	1.539"	1.736"	1.988"	2.185"
TW2018	18 X 18	46.99mm/1.850"	1.641"	1.838"	2.090"	2.287"

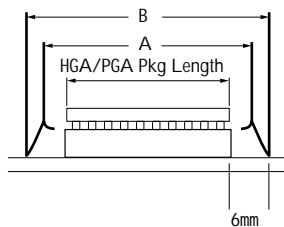

1. Spread the tool open and push it down over the HGA/PGA device.

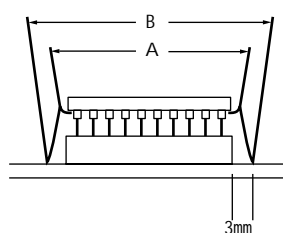

2. Turn the knurled disk clockwise; the lifting mechanism slowly extracts the chip from the socket.

### HOW TO ORDER

- 1) Decide whether you need an insertion or extraction tool.
- 2) Find your grid size (8X8, 9X9, etc.) in the appropriate tool table.
- 3) Locate the correct part # and use it to order.

# LAB & REWORK ACCESSORIES - INSERTION/EXTRACTION TOOLS - PGA/HGA

## HGA/PGA MULTI-GRID SIZE EXTRACTION TOOL

- Extracts Pin-Grid-Array (PGA) devices measuring 10 X 10 to 15 X 15 and 16 X 16 to 22 X 22 and HGA devices measuring 31X31 to 43X43 from sockets with high extraction force
- Two grip claws hug the socket from underneath on both sides
- Solid aluminium crossbars, 18mm thick, allow even load distribution during extraction
- Lifting range of about 15mm allows extraction of PGA devices with attached disk heat sinks

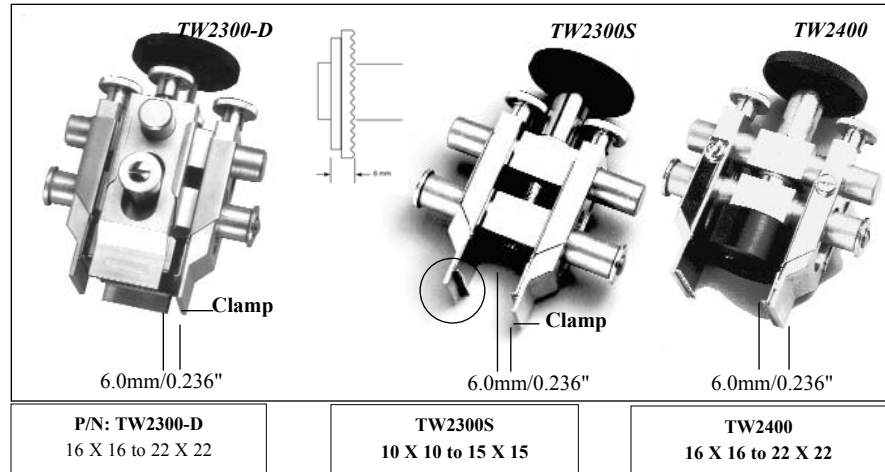

## HGA/PGA MULTI-GRID SIZE EXTRACTION TOOLS

### Adjustable extraction for both low and high profile socketed PGAs.

These extractors combine all of the features and benefits of previous designs in an adjustable tool. The 1050 series can be easily changed from a low profile setting with a simple screw adjustment.

Available in four sizes, covering an operating range of 1" to 3", the 1050 series adds flexibility to fast, safe, reliable PGA extraction. For those operations that involve variable extraction requirements the 1050 series provides the ideal solution.

\* H = heavy duty stainless steel.

**Note:** .100" clearance required between adjacent Pin Grid Arrays.

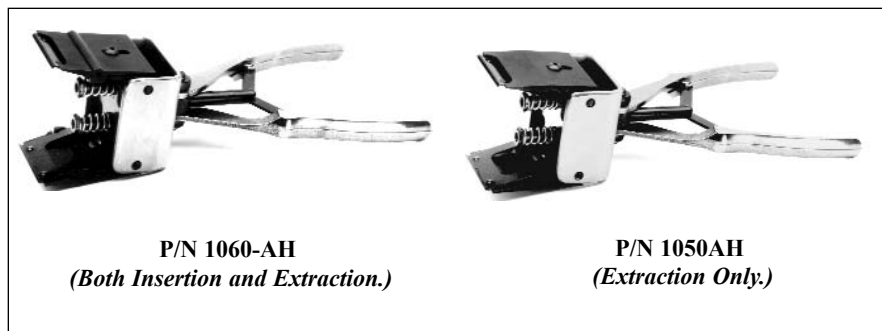

Part #	PGA Range (.100 center)	Part #	PGA Range (.100 center)
P/N-1060	10 X 10 to 14 X 14	P/N-1050-AH*	15 X 15 to 19 X 19
P/N-1060-AH*	15 X 15 to 19 X 19	P/N-1050-BH*	20 X 20 to 24 X 24
P/N-1060-BH*	20 X 20 to 24 X 24		

LAB & REWORK ACCESSORIES

## HGA/PGA INSERTION

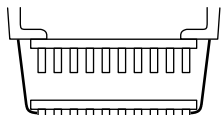

1. Remove side plates. Position tool with side springs under socket.

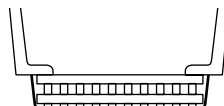

2. Squeeze handle slowly and firmly to insert PGA.

## HGA/PGA EXTRACTION

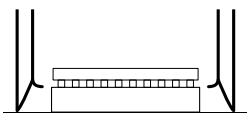

1. Tool steadily straddles PGA.

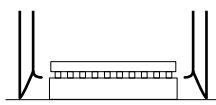

2. Squeeze of handle produces firm grip of PGA. Tool remains steady on base.

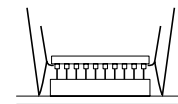

3. Continued squeeze action . . . **without pulling** . . . *lifts* PGA from board.